



This is a digital copy of a book that was preserved for generations on library shelves before it was carefully scanned by Google as part of a project to make the world's books discoverable online.

It has survived long enough for the copyright to expire and the book to enter the public domain. A public domain book is one that was never subject to copyright or whose legal copyright term has expired. Whether a book is in the public domain may vary country to country. Public domain books are our gateways to the past, representing a wealth of history, culture and knowledge that's often difficult to discover.

Marks, notations and other marginalia present in the original volume will appear in this file - a reminder of this book's long journey from the publisher to a library and finally to you.

### **Usage guidelines**

Google is proud to partner with libraries to digitize public domain materials and make them widely accessible. Public domain books belong to the public and we are merely their custodians. Nevertheless, this work is expensive, so in order to keep providing this resource, we have taken steps to prevent abuse by commercial parties, including placing technical restrictions on automated querying.

We also ask that you:

- + *Make non-commercial use of the files* We designed Google Book Search for use by individuals, and we request that you use these files for personal, non-commercial purposes.
- + *Refrain from automated querying* Do not send automated queries of any sort to Google's system: If you are conducting research on machine translation, optical character recognition or other areas where access to a large amount of text is helpful, please contact us. We encourage the use of public domain materials for these purposes and may be able to help.
- + *Maintain attribution* The Google "watermark" you see on each file is essential for informing people about this project and helping them find additional materials through Google Book Search. Please do not remove it.
- + *Keep it legal* Whatever your use, remember that you are responsible for ensuring that what you are doing is legal. Do not assume that just because we believe a book is in the public domain for users in the United States, that the work is also in the public domain for users in other countries. Whether a book is still in copyright varies from country to country, and we can't offer guidance on whether any specific use of any specific book is allowed. Please do not assume that a book's appearance in Google Book Search means it can be used in any manner anywhere in the world. Copyright infringement liability can be quite severe.

### **About Google Book Search**

Google's mission is to organize the world's information and to make it universally accessible and useful. Google Book Search helps readers discover the world's books while helping authors and publishers reach new audiences. You can search through the full text of this book on the web at <http://books.google.com/>



Per. 1772 e.  $\frac{8}{35.45}$

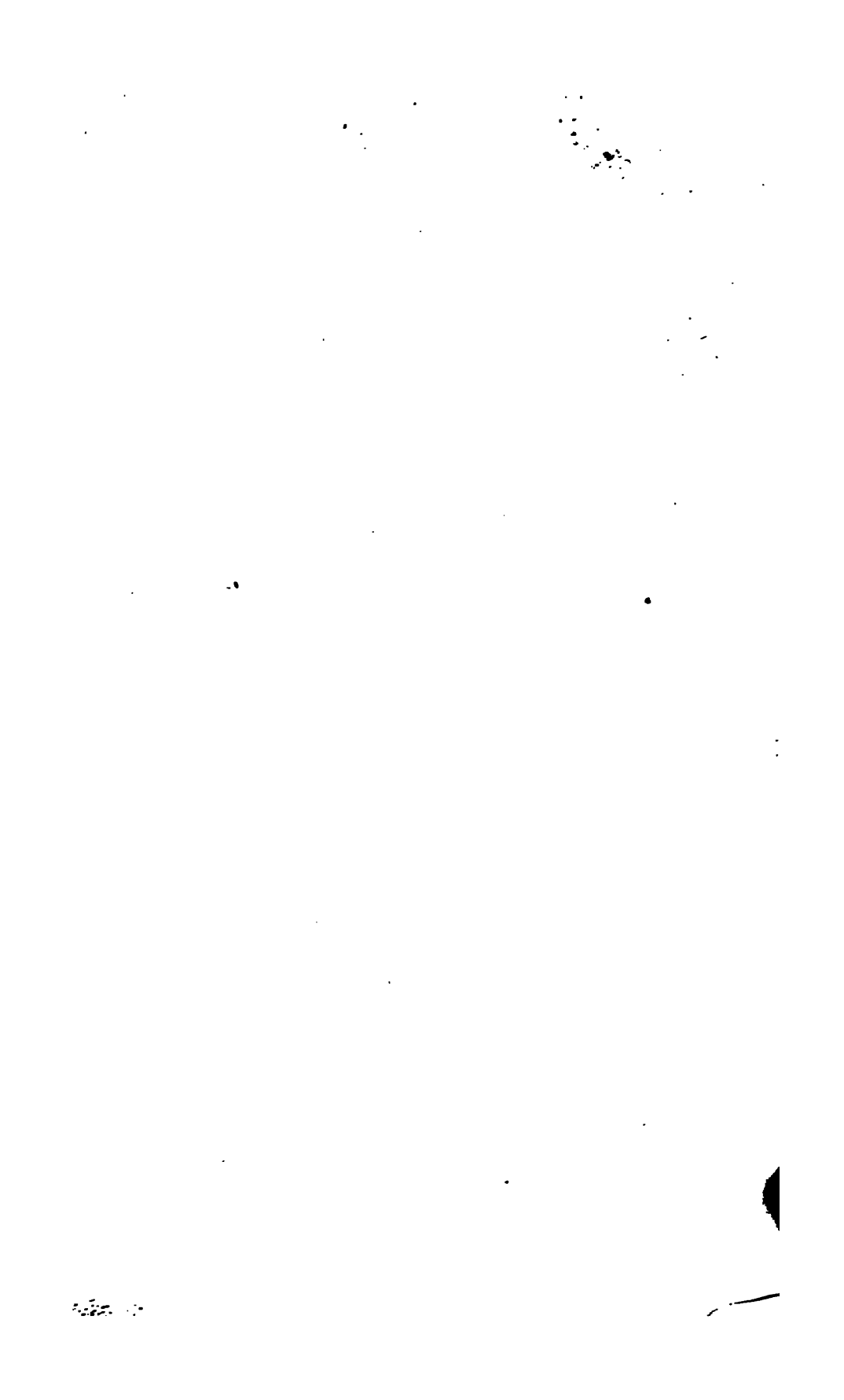









THE  
LONDON JOURNAL  
OF  
*Arts, Sciences, and Manufactures,*  
AND  
REPERTORY  
OF  
PATENT INVENTIONS.

---

CONDUCTED BY  
MR. W. NEWTON,  
OF THE OFFICE FOR PATENTS, CHANCERY LANE.

*(Assisted by several Scientific Gentlemen.)*

---

VOL. XLV.  
*(CONJOINED SERIES.)*

---



LONDON:

PUBLISHED BY W. NEWTON, AT THE OFFICE FOR PATENTS, 66, CHANCERY-LANE, AND MANCHESTER; T. AND W. PIPER, PATERNOSTER ROW; SIMPKIN, MARSHALL, AND CO., STATIONERS' COURT; J. MCCOMBE, BUCHANAN ST., GLASGOW; AND GALIGNANI'S LIBRARY, RUE VIVIENNE, PARIS.

---

1854.

---

**R. FOLKARD, PRINTER, DEVONSHIRE STREET,  
QUEEN SQUARE.**

---

## LIST OF PLATES IN VOL. XLV.

[CONJOINED SERIES.]

---

- I. Jordan's machinery for Planing Slate; Kraut's Blasting Rocks; Davis' Apparatus for Testing Coin; Chappuis' Diurnal Reflectors; Newton's Impts. in Crushing Gold; and Taylor's Impd. Water Meter.
- II. Hunt's Impts. in Manufacturing Sulphuric Acid; May's Impd. Brick Machine; Baker's ditto; Bradley and Craven's ditto; Cochran's Gold Crushing Machinery; Pooley's Apparatus for Cleaning Cotton; Worrall's Impd. Dyeing Apparatus; and Reeves' Swords.
- III. Walmsley and Holmes' Impts. in Steam-Engines; Griffith's ditto; Johnson's ditto; Huntley's ditto; and Barker and Holt's Grinding Metals.
- IV. Williams' Impd. Machinery for Cutting Iron; Breffitt's Glass-House Pots; Elce's Impts. in Spinning; Bessemer's Sugar Moulding Apparatus; Goodall's Impts. in Grinding; and Adams' Apparatus for Feeding Boilers.
- V. Adams' Railway Wheels, &c.; Chambers' Cutting Pile Fabrics; Nash's Impts. in Filters; Bernard's Impts. in Sewing Machinery; Watson's Light; Hughes' Embossing Velvets, &c.; Witty's Impd. Furnace; Keates' Distilling Apparatus; and Dickson's Flax Breaker.
- VI. Hollinsworth's Railway Brake; Newton's ditto; Parkinson's Gas Regulator; Andrew's Window Sash Fastener; Brooman's Paper; Fraser's Portable Packages; Lovell's Apparatus for Heating Buildings; Brooman's Carding Silk; Johnson's Impts. in Cutting Paper; and Crabtree's Winding Yarn.

VII. De Bergue's Moulding Apparatus; Nasmyth's Impts. in Steam Hammers; Coates' Impts. in Coupling Pipes; Roughton's Boilers; Dundonald's Impts. in Laying Drain Pipes; Williams' Water-Closets; Bentley's Impd. Boilers; and Johnson's Steam-Engines.

VIII. Hippisley's Agricultural Engine; Seaward's Marine Engine; Westley's Apparatus for Combing; Willis' Impts. in Organs; Stevens' Axle Box; Corlett's Impts. in Railway Waggon; Nairne's Dressing Yarns; and Sibbald's Float.

IX. Whitehead's Impd. Combing Machinery; Taylor & Brown's Charring Peat; Leeson's Impd. Gas Burners; Twigg and Silvester's Apparatus for Affixing Stamps; Naylor's ditto; Parnell's Impts. in Locks; Milner's ditto; and Chisholm's Manufacturing Manure.

X. Howell and Jamieson's Saw-Cutting Machinery; Atkinson's Thrashing Machinery; Rigby's Steam Hammers; Mohler's Lubricating Apparatus; Tilghman's Treating Fatty Matters; Poole's Printing Rollers; and Fatio and Verdeil's Preserving.

XI. Townsend's Impd. Sewing Machine; Hunt's ditto; Jennings' ditto; Bernard's Impts. in Boots and Shoes; Little's Apparatus for Distilling Coal; and Kershaw's Locomotive Engine.

XII. Clibran's Gas Regulator; Hulett's ditto; Whitehead's Impd. Cutting Tools; Holman's Impts. in Pumps; Massey's Ship's Log; Newton's Gold Crushing; Smith's Valve; Jobson's Impts. in Moulding; Wright and Brown's Cupolas; and Elder's Impts. in Steam-Engines.

---

## INDEX TO VOL. XLV.

### [CONJOINED SERIES.]

	Page		Page
Acid, impts. in manufacturing phosphoric, Richardson's patent .....	267	Buoys, impts. in illuminating, Sheringham's patent .....	270
—, sulphuric, Hunt's patent .....	37	—, for communicating from vessels to the shore, &c., impts. in, Sibbald's patent .....	272
—, —, Leyland's patent .....	269	Candles and night-lights, impts. in making, Wilson's patents .....	211, 445
Adjudication, Scientific:—		—, impts. in mould, Austen's patent .....	209
Hyde v. Trent .....	135	—, impts. in wicks for, Nash's patent .....	30
Animal substances, impts. in charring, Taylor and Brown's patent .....	325	Canvas, impts. in waterproofing, White's patent .....	361
—, —, distilling, Chisholm's patent .....	279	Carpets, impts. in the manufacture of, Fawcett's patent ...	212
—, —, preserving, Fontainemoreau's patent .....	25	Casting in metals, Jobson's patent .....	432
—, —, Fatio and Verdeil's patent .....	354	Castings from malleable iron, impts. in producing, Brooman's patent .....	119
Axles and axle-boxes, impts. in, Adams' patent .....	157	—, impts. in removing patterns from moulds for, De Bergue's patent .....	259
Axle-box for railway carriages, impts. in, Steven's patent ...	246	Celestial phenomena, 76, 156, 236, 316, 396, 476	
Bands for packing lace, &c., impts. in, Dilks' patent .....	359	Cement, impts. in obtaining li- quid, Bell's patent .....	122
Bearings and packing, impts. in, Kington's patent .....	252	Charring animal and vegetable substances, impd. apparatus for, Taylor and Brown's patent .....	325
Boilers, impts. in, Bentley's patent .....	242	Cleaning and blowing cotton, impd. apparatus for, Pooley's patent .....	19
—, —, Roughton's patent .....	242	Coating cast-iron with copper and brass, impts. in, Newton's patent .....	109
—, —, apparatus for regulating the supply of water to, Adams' patent .....	92	— ships' bottoms, &c., impd. composition for, Brown- ing's patent .....	111
Boots and shoes, impts. in the manufacture of, Bernard's patent .....	416	Combing fibrous substances, impd. gill for, Westly's patent .....	263
Boring rocks for blasting purposes, impd. tool for, Kraut's patent .....	49	— wool, impts. in machi- nery for, Whitehead's patent .....	317
Brakes for railways, impts. in, Newton's patent .....	198	Cotton, impts. in blowing and cleaning, Pooley's patent ...	19
—, —, railway carriages, impts. in applying, Hollins- worth's patent .....	200	Coupling pipes, impts. in appa- ratus for, Coates' patent .....	254
Bricks, impts. in making per- forated, May's patent .....	1	Crushing gold ores, &c., impts. in, Newton's patent .....	13, 437
—, —, impd. moulds for mak- ing perforated, Baker's patent .....	5	—, —, Cochran's patent .....	43
—, —, impts. in the manufac- ture of, Bradley and Craven's patent .....	6		
—, —, impd. composition for, Hustwayte and Gibson's pa- tent .....	353		



	Page	Page	
Cupolas for fusing cast-iron, Spencer's patent .....	116	moulds for casting metals, 381;—description of wrought-iron station-roof at Birmingham, 453;—an improved water-filter.....	451
—, impts. in, Wright and Brown's patent .....	430	Engines, impts. in agricultural, Hippisley's patent .....	239
Cutting and shearing iron, impd. machinery for, Williams' paper, impd. machinery for, Johnson's patent .....	202	—, ——— locomotive, &c., Kershaw's patent .....	420
— piled fabrics, Chalmers' patent .....	195	—, ——— marine, Seaward's patent .....	245
— tools, impts. in, Whitehead's patent .....	411	—, ———, Elder's patent .....	432
Deodorizing waterproof fabrics, impts. in, Fry's patent .....	362	—, impts. in steam, Johnson's patent.....	80
Disinfecting sewage, impts. in, Dimsdale's patent .....	20	—, ———, Walmsley and Holmes' patent.....	82
Distilling animal and vegetable substances, Chisholm's patent .....	279	—, ———, Griffiths' patent .....	86
— coal, Little's patent .....	414	—, ———, Huntley's patent .....	89
— turpentine, impd. apparatus for, Keates' patent... ..	172	—, ———, Johnson's patent .....	240
Drain-pipes, impts. in apparatus for laying, Dundonald's patent .....	248	Exhibition at Paris in 1855, protection of designs and inventions contained in .....	126
Dressing yarn, impd. apparatus for, Nairne's patent .....	275	Fabrics, impts. in cutting piled Chalmers' patent.....	195
Dyeing and cleansing cotton, impts. in, Barnes' patent ... ..	210	—, ——— dyeing and cleansing, Barnes' patent ... ..	210
— fustians, &c., impd. apparatus for, Worrall's patent .....	47	—, ——— manufacturing waterproof, White's patent .....	361
Electric lock, Whishaw's patent .....	29	—, ———, Goodyear's patent .....	265
— telegraphs, impts. in, Dering's patent .....	112	—, ——— preparing and deodorizing waterproof, Fry's patent .....	362
—, ———, impts. in constructing insulators of glass or porcelain, Green's patent .....	208	—, ——— producing fancy patterns in, Hughes' patent .....	167
Engineers, transactions of the Institution of Civil:— On the casualties of tunnelling, 55;—on the means of avoiding smoke from boiler furnaces.....	446	—, ——— treating wool-len, Wilson's patent .....	262
—, ———, Mechanical Institution of:—On a new winding-engine, 56;—on an improved water-meter, 58;—on the American dry clay brick-making machine, 60;—on combing fibrous materials, 127;—on the retardation and stoppage of railway trains, 130;—an improved water-meter, 213;—an improved locomotive engine, 285;—Berdan's crushing and amalgamating machine, 289;—new railway train signal, 293;—safety apparatus for working mine-shafts, 378;—		Fastening for windows, impd. construction of, Andrew's patent .....	175
		Fatty and oily matters, impts. in treating, Pidding's patent .....	274
		—, ——— Hutchison's patent .....	278
		—, ———, impd. apparatus for treating, Tilghman's patent .....	343
		Files, impts. in renewing the teeth of, Grillet's patent ... ..	107
		Filters, impts. in, Nash's patent .....	166
		Flax, &c., impts. in machinery for preparing, Dickson's patent .....	169
		Float for communicating intelligence from vessels to the shore, Sibbald's patent .....	272

	Page		Page
Floor cloths, impts. in printing, Wells' patent .....	439	Labels and postage stamps, impts. in affixing and cutting, Twigg and Silvester's patent	329
Furnace for consuming smoke, impd. construction of, Witty's patent .....	196	Lace fabrics, impts. in the ma- nufacture of, Dunnicliff and Bagley's patent .....	35
— for smelting iron, Wright and Brown's patent .....	430	—, impts. in manufacturing gold and silver, Masson's pa- tent .....	335
Gas-burners, impts. in, Leeson's patent .....	321	—, packing-bands for, Dilks' patent .....	359
—, impts. in appara- tus for regulating the pres- sure of, Parkinson's patent	205	Lamp-wicks, impts. in the ma- nufacture of, Nash's patent	30
—, Clibran's patent .....	425	Leather, impts. in manufac- turing, Kennedy's patent ...	347
—, Hulett's patent .....	423	—, Taylor's patent .....	350
—, impts. in manu- facturing, Little's patent ...	414	—, imitation, Kohnstamm's patent .....	281
—, purifying, Chisholm's patent .....	427	Light, impts. in producing, Watson's patent .....	162
Gelatinous substances, impts. in purifying, Pidding's patent	274	Locks, impts. in electric, Whi- shaw's patent .....	29
Glass, impts. in ornamenting, Barthelemy, Petitjean, and Bourquin's patent ..	256	— for safes, &c., impts. in, Milner's patent .....	327
— house pots, impd. con- struction of, Breffit's patent	97	—, Parnell's patent .....	351
Glycerine, impts. in manufac- turing, Tilghman's patent ...	343	—, Tucker and Reeves' patent .....	375
Gold-crusher, an impd., New- ton's patent .....	13, 437	Lubricating machinery, impts. in apparatus for, Mohler's patent .....	337
—, Cochran's patent .....	43	Madder, impts. in purifying and concentrating the coloring matter of, Hughes' patent ...	211
— and silver lace, impts. in manufacturing, Masson's pa- tent .....	335	Manure, impts. in the manufac- ture of sewage, Wicksteed's patent .....	444
Grinding and turning metals, impts. in, Barker and Holt's patent .....	95	—, Chisholm's patent .....	370
— or levigating, impd. apparatus for, Goodall's pa- tent .....	99	Metals, impts. in coating, New- ton's patent .....	109
Gutta-percha, impts. in prepar- ing solvents for, Fry's patent	362	Money, impts. in apparatus for distinguishing genuine from counterfeit, Davis' patent ...	27
Heating and ventilating, impts. in, Lovell's patent .....	181	Moulds for castings, impts. in removing patterns from, De Bergue's patent .....	259
India-rubber, impts. in prepar- ing solvents for and deodor- izing, Fry's patent .....	362	— for casting metals, impts. in, Jobson's patent .....	434
Insulating telegraph wires, impd. means of, Dering's pa- tent .....	112	Naphtha, impts. in the treat- ment of, Calvert's patent ...	282
Insulators, impts. in construct- ing, Green's patent .....	208	Night-lights and candles, impts. in the manufacture of, Wil- son's patent .....	211, 445
Iron, impts. in coating, New- ton's patent .....	109	Oils, &c., impts. in treating, Pidding's patent .....	274
—, impts. in producing cast- ings from malleable, Broo- man's patent .....	119	—, Hutchison's patent .....	278
Labels and postage stamps, impts. in affixing, Naylor's patent .....	331	—, Tilghman's patent .....	343
		Organs, impts. in the construc- tion of, Willis' patent .....	249

	Page		Page
Ornamenting glass, impts. in, Barthélemy, Petitjean, and Bourquin's patent .....	256	Barthélemy, E., Petitjean, T., and Bourquin, J. P., for impts. in ornamenting glass .....	256
—, metals and papier-maché, Breese's patent	123	Bell, G., for impts. in obtaining liquid cement and paints ...	122
— paper, Durandean's patent .....	180	Bentley, H., for impts. in steam- boilers .....	242
Packages, impts. in portable, Fraser's patent .....	194	Bernard, J., for impts. in sew- ing-machines .....	185
Packing and bearings of ma- chinery, impts. in, Kingston's patent .....	252	—, for impts. in the manufacture of boots and shoes .....	416
Paints, &c., impts. in obtaining, Bell's patent .....	122	Bessemer, H., for the manufac- ture and refining of sugar ...	101
—, impts. in preparing, Grenier's patent .....	255	Bradley, R., and Craven, W., for impts. in the manufacture of bricks .....	6
Paper from peat, impts. in the manufacture of, Lallemand's patent .....	26	Breese, C., for forming designs on papier-maché, &c. ....	123
— from wood, impts. in the manufacture of, Brooman's patent .....	178	Breffit, E., for the manufacture of glass-house pots .....	97
— for obtaining designs in, Durandean's patent .....	180	Brooman, R. A., for producing castings from malleable iron —, for the manu- facture of paper .....	119 178
—, impts. in machinery for cutting, Johnson's patent ...	202	—, for impts. in the treatment of wool and silk	183
Parchment, impts. in the ma- nufacture of, Smith's patent	177	Brown, I. and J., and Taylor, J., for impts. in charring peat, &c. ....	325
Patent law, the new Belgic ...	51	—, G., and Wright, W., for impts. in cupolas, &c. ...	430
—, lists of grants of provisional protections under 62, 138, 221, 297, 386,	460	Browning, H., for coating ships' bottoms, &c. ....	111
Patents, lists of new, granted in England, 74, 154, 234, 314, 394,	474	Bourquin, J. B., Barthélemy, E., and Petitjean, T., for impts. in ornamenting glass .....	256
— in Scotland .....	73	Calvert, F. C., for the treatment of naphthas, &c. ....	282
PATENTS, REPORTS OF RECENT.			
Adams, S., for regulating the supply of water to boilers, &c.	92	Chalmers, D., for impts. in cut- ting the pile of woven fabrics	195
—, W. B., for impts. in rail- way-wheels, axles, and boxes	157	Chappuis, E., for impts. in day- light reflectors .....	11
Aldred, W., Fenton, R., and Crone, W., for impts. in separ- ating wool from cotton and other fabrics .....	117	Chell, W. Mc E., and Royle, B., for impts. in treating silk- waste .....	118
Andrew, M., for impts. in win- dow-sash fastenings .....	175	Chisholm, J., for the distillation of organic substances .....	279
Atkinson, J., for impts. in thrashing-machines .....	323	—, for manufacturing artificial manures .....	370
Austen, A. J., for impts. in candle-moulds .....	209	—, for purifying gas	427
Bagley, J. W., and Dunningcliff, J. D., for the manufacture of lace fabrics .....	35	Clibran, W., and J., for regu- lating the supply of gas ...	425
Baker, C., for impts. in the ma- nufacture of bricks .....	5	Coates, C., for impts. in coup- ling-pipes, &c. ....	254
Barker, H., and Holt, F., for grinding and turning metals	95	Cochran, J. W., for impts. in crushing and grinding stone, &c. ....	43
Barnes, J., for impts. in dyeing and cleansing cotton, &c. ...	210	Collette, C. H., for the manu- facture of sugar .....	357
		Corlett, H., for impts. in rail- way waggons .....	276

	Page		Page
Crabtree, J., for impts. in winding and doubling yarn .....	193	Green, R., for constructing glass or porcelain insulators .....	208
Craven, W., and Bradley, R., for impts. in the manufacture of bricks .....	6	Grenier, C., for the preparation of paints .....	255
Crone, W., Aldred, W., and Fenton, R., for impts. in separating wool from cotton and other fabrics .....	117	Griffiths, J., for impts. in steam-engines .....	86
Davis, G., for distinguishing genuine from counterfeit coin .....	27	Grillet, E., for renewing the teeth of files .....	107
De Bergue, C., for removing patterns from moulds for castings .....	259	Hippisley, J., for impts. in agricultural steam-engines .....	239
Dering, G. E., for impts. in electric telegraphs .....	112	Hollinsworth, T., for impts. in applying railway brakes ...	200
Dickson, J. H., for impts. in machinery for preparing flax .....	169	Holman, S., for impts. in pumps .....	442
Dilks, J., for impts. in bands for packing lace, &c. ....	359	Holmes, J., and Walmaley, E., for impts. in steam-engines .....	82
Dimsdale, T. I., for disinfecting sewage, &c. ....	20	Holt, F., and Barker, H., for grinding and turning metals .....	95
Dundonald, Earl of, for impts. in apparatus for laying pipes in the earth .....	248	Howell, J. B., and Jamieson, W., for impts. in the manufacture of saws .....	364
Dunnicliff, J. D., and Bagley, J. W., for the manufacture of lace fabrics .....	35	Hughes, H., for producing fancy patterns in velvets, &c. ....	167
Durandean, J., for obtaining marks and designs in paper .....	180	——, E. J., for extracting coloring matter from various substances .....	211
Elce, J., for impts. in preparing and spinning cotton, &c. ...	77	Hulett, D., for impts. in gas regulators .....	423
Elder, J., for impts. in marine steam-engines .....	432	Hunt, W., for manufacturing sulphuric acid .....	37
Falconi, M., for a composition for preserving the dead .....	360	——, N., for impts. in apparatus for sewing .....	401
Fatio, A. M., and Verduil, F., for preserving animal and vegetable substances .....	354	Huntley, W., for impts. in steam-engines .....	89
Fawcett, W., and F. B., for the manufacture of carpets .....	212	Hustwayte, B., and Gibson, R. J. P., for an impd. composition applicable to the manufacture of bricks .....	353
Fenton, R., Crone, W., and Aldred, W., for impts. in separating wool from cotton and other fabrics .....	117	Hutchison, G., for treating oils and other fatty matters .....	278
Fontainemoreau, P. A. Le Comte de, for impts. in preserving milk, &c. ....	22	Jamieson, W., and Howell, J. B., for impts. in the manufacture of saws .....	364
Fraser, J., for impts. in the manufacture of portable packages .....	194	Jennings, H. C., for the manufacture of soap .....	33
Fry, J., for preparing and rendering waterproof fabrics free from odour .....	362	——, L., for impts. in sewing machinery .....	397
Gibson, R. J. P., and Hustwayte, B., for an impd. composition applicable to the manufacture of bricks .....	353	Jobson, J. and R., for impts. in moulds for casting metals ...	434
Goodall, H., for an impd. apparatus for grinding or levigating various substances .....	99	Johnson, J. H., for impts. in steam-engines .....	80
Goodyear, C., for waterproofing coarse fabrics .....	265	——, for impts. in machinery for cutting paper .....	202
		——, W. B., for impts. in steam-engines .....	240
		Jordan, T. B., for impts. in machinery for planing slate ...	9
		Keates, T. W., for the distillation of turpentine, &c. ....	172
		Kennedy, D., for certain compositions to be used in the manufacture of leather .....	347

	Page		Page
Kershaw, J., for impts. in steam-engines .....	420	Reeves, C., for impts. in swords	12
Kingston, J. P., for impts. in the bearings and packings of machinery .....	252	—, W. R., and Tucker, W. H., for impts. in locks...	375
Kohnstamm, H., for the manufacture of imitation leather...	281	Richardson, T., for manufacturing certain compounds containing phosphoric acid...	267
Kraut, H., for impts. in tools for boring or cutting rocks, &c.	49	Rigby, W., for impts. in steam-hammers, &c. ....	333
Lallemand, J., for the manufacture of paper from peat .....	26	Robinson, G., for forming sheets or plates from slags.....	120
Leeson, H. B., for impts. in gas-burners .....	321	Roughton, R., for impts. in steam-boilers, &c. ....	242
Le Gros, A. E. P., for impts. in preserving timber .....	440	Royle, B., and Chell, W. Mc E., for impts. in treating silk waste.....	118
Leyland, E., for the manufacture of sulphuric acid .....	269	Schollick, E. J., for impts. in obtaining motive power .....	106
Little, W., for impts. in distilling coal .....	414	Scoutetten, H. J., for an impd. plastic compound .....	24
Lovell, J., for impts. in heating and ventilating .....	181	Seaward, J., for impts. in marine steam-engines .....	245
Massey, E., for impts. in ships' logs .....	428	Sheringham, W. L., for illuminating buoys and beacons ...	270
Masson, A. A., for manufacturing gold and silver lace .....	335	Sibbald, R. J., for an impd. float for communicating from vessels to the shore.....	272
May, C., for impts. in the manufacture of bricks .....	1	Silvester, A. L., and Twigg, G., for impts. in apparatus for cutting and affixing stamps and labels .....	329
Milner, W., for impts. in locks for safes, &c.....	327	Smith, W. H., for the manufacture of parchment .....	177
Mohler, A., for impts. in lubricating apparatus.....	337	—, S., for an impd. construction of valve .....	415
Nairne, W., for impts. in dressing yarns for looms .....	275	Spencer, J., for an impd. cupelo for fusing cast-iron .....	116
Nash, E. and J., for the manufacture of wicks .....	30	Steven, J., for an impd. axle-box for railway carriages, &c.	246
—, T. R., for impts. in filters	166	Sykes, T., for the treatment of soapy and greasy waters ...	284
Nasmyth, J., for impts. in pistons and piston-rods of steam-hammers .....	237	Taylor, J., and Brown, I. and J., for impts. in charring peat, &c.	325
Naylor, H. M., for impts. in apparatus for affixing postage and other stamps .....	331	—, J., for the preparation of skins .....	350
Newton, A. V., for impts. in machinery for crushing ores	437	—, T., for an impd. water-meter.....	17
—, W. E., for impts. in crushing ores, &c. ....	13	Tilghman, R. A., for treating fatty and oily matters .....	343
—, W., for coating cast-iron with other metals .....	109	Townsend, E., for impd. machinery for sewing .....	405, 408
—, S., for impts. in railway brakes .....	198	Troupeau, C., for an impd. diurnal reflector .....	10
Parkinson, J., for regulating the pressure of steam, gas, &c.	205	Tucker, W. H., and Reeves, W. R., for impts. in locks ...	375
Parnell, M. L., for impts. in locks	351	Twigg, G., and Silvester, A. L., for impts. in apparatus for cutting and affixing stamps and labels .....	329
Petitjean, T., Barthélemy, E., and Bourquin, J. B., for impts. in ornamenting glass	256	Verdeil, F., and Fatio, A. M., for preserving animal and vegetable substances .....	354
Pidding, W., for the treatment of oils and fatty bodies .....	274	Walmsley, E., and Holmes, J., for impts. in steam-engines	82
Poole, M., for the manufacture of printing rollers .....	339		
Pooley, C., for impts. in apparatus for blowing and cleaning cotton, &c.....	19		

	Page		Page
Watson, J. J. W., for impts. in producing light .....	162	Power, impts. in obtaining motive, Schollick's patent .....	106
Wells, B. W., for impts. in printing floor-cloths .....	439	Preserving animal and vegetable substances, Fatio and Verdeil's patent .....	354
Westly, W. K., for threackling, drawing, and roving fibrous substances .....	263	— milk, &c., impts. in, Fontainemoreau's patent .....	25
Whishaw, F., for an impd. lock or system of locks, by electricity .....	29	— the dead, impd. composition for, Falconi's patent .....	360
White, D. B., for the manufacture of waterproof fabrics ..	361	— timber, Le Gros' patent .....	440
Whitehead, T., for impts. in combing, drawing, and spinning wool .....	317	Printing floor-cloths, impts. in, Wells' patent .....	439
—, J. and T., for impts. in cutting tools .....	411	Printing-rollers, impts. in the manufacture of, Poole's patent .....	339
Wicksteed, T., for the manufacture of sewage manure ..	444	Pumps, impd. construction of, Holman's patent .....	442
Williams, O., for impts. in water-closets .....	252	Railway-brakes, impts. in, Newton's patent .....	198
—, W., for impts. in cutting and shearing iron, &c. ....	93	—, impts. in applying, Hollinsworth's patent ..	200
Willis, H., for impts. in the construction of organs .....	249	— carriages, impd. axle-box for, Steven's patent .....	246
Wilson, G. F., for the manufacture of candles and night-lights .....	211, 445	— waggons, impts. in, Corlett's patent .....	276
—, for the manufacture of cloths, &c. ....	261	— wheels, &c., impts. in, Adams' patent .....	157
—, for impts. in treating wool, &c. ....	262	Refining and manufacturing sugar-loaves, Bessemer's patent .....	101
Witty, R. C., for the construction of boiler and other furnaces .....	196	Reflectors, impts. in daylight, Troupeau's patent .....	10
Worrall, J., for dyeing fustians and other fabrics .....	47	—, Chappuis' patent .....	11
Wright, W., and Brown, G., for impts. in cupolas, &c. ...	430	Rocks, impd. tool for boring, Kraut's patent .....	49
Peat, impts. in charring, Taylor and Brown's patent .....	325	Roofing, impts. in, Robinson's patent .....	120
Phosphoric acid, impts. in the manufacture of, Richardson's patent .....	267	Saws, impts. in manufacturing, Howell and Jamieson's patent ..	364
Pipes, impts. in apparatus for laying drain, Dundonald's patent .....	248	Sewage, &c., impts. in disinfecting, Dimsdale's patent ...	20
—, impts. in coupling, Coates' patent .....	254	— manure, impts. in the manufacture of, Wicksteed's patent .....	444
Planing slate, impd. machinery for, Jordan's patent .....	9	Sewing, impts. in machinery for, Bernard's patent .....	185
Plastic compound, Scoutetten's patent .....	24	—, Jennings' patent .....	397
—, Hustwayte and Gibson's patent .....	353	—, Hunt's patent .....	401
Postage stamps, impts. in affixing, Naylor's patent .....	329	—, Townsend's patents .....	405, 408
—, impts. in cutting and affixing, Twigg and Silvester's patent .....	331	Shearing and cutting iron, impd. machinery for, Williams' patent .....	93
		Ships' bottoms, &c., impts. in coating, Browning's patent ..	111
		— logs, impd. construction of, Massey's patent .....	428

	Page		Page
Silk, &c., impts. in ornamenting, Hughes' patent .....	167	Turning and grinding metals, impts. in, Barker and Holt's patent .....	95
— and wool, impts. in treating, Brooman's patent .....	183	Turpentine, impts. in apparatus for distilling, Keates' patent .....	172
— waste, impts. in treating, Royle and Chell's patent ...	118	Valve, impd. construction of, Smith's patent .....	415
Silver lace, impts. in the manufacture of, Masson's patent .....	335	Vegetable substances, impts. in charring, Taylor and Brown's patent .....	325
Slags, impts. in forming sheets or plates from, Robinson's patent .....	120	—, distilling, Chisholm's patent .....	279
Slate, impts. in machinery for planing, Jordan's patent ...	9	—, preserving, Fontainemoreau's patent ...	25
Soap, impts. in the manufacture of, Jennings' patent ...	33	—, Fatio and Verdeil's patent .....	354
—, Tilghman's patent .....	343	Velvets, impts. in ornamenting patterns in, Hughes' patent .....	167
Soapy and greasy waters, impts. in the treatment of, Sykes' patent .....	284	Ventilating and heating, impts. in, Lovell's patent .....	181
Spinning, impts. in machinery for, Elce's patent.....	77	Waggons, impts. in railway, Corlett's patent .....	276
—, Whitehead's patent .....	317	Water-closets, impts. in, Williams' patent .....	252
Stamps, impts. in affixing, Naylor's patent .....	331	Water-meter, impd. construction of, Taylor's patent .....	17
— and cutting, Twigg and Silvester's patent .....	329	Waterproof fabrics, impts. in the manufacture of, White's patent .....	361
Steam-gauge, impd. construction of, Parkinson's patent .....	205	—, Goodyear's patent .....	265
Steam-hammers, impts. in, Nasmyth's patent .....	237	—, preparing and deodorizing, Fry's patent .....	362
—, Rigby's patent .....	333	Wheels, impts. in railway, Adams' patent.....	157
Sugar, impts. in the manufacture and refining of, Bessemer's patent .....	101	Wicks, impts. in, Nash's patent .....	30
—, Collette's patent .....	357	Winding and doubling yarn, impd. apparatus for, Crabtree's patent .....	193
Sulphuric acid, impts. in the manufacture of, Hunt's patent .....	37	Windows, impts. in fastenings for, Andrew's patent .....	175
—, Leyland's patent .....	269	Wires of electric telegraphs, impts. in insulating .....	113
Swords, impts. in, Reeves' patent .....	12	—, impts. in constructing insulators of glass or porcelain for, Green's patent .....	208
Telegraphs, impts. in electric, Dering's patent .....	112	Wool, impts. in recovering, Aldred, Fenton, and Crone's patent .....	117
—, impts. in insulators for, Green's patent .....	208	— and silk, impts. in treating, Brooman's patent .....	183
Thrashing, impd. machinery for, Atkinson's patent .....	323	— and woollen cloths, impts. in treating, Wilson's patents .....	261, 262
Tills for distinguishing genuine from counterfeit coin, Davis' patent .....	27	Yarns, impts. in dressing, Nairne's patent .....	275
Timber, impts. in preserving, Le Gros' patent .....	440	—, impts. in winding and doubling, Crabtree's patent .....	193
Tools, &c., impts. in cutting, Whitehead's patent.....	411		

THE  
LONDON JOURNAL,  
AND  
REPERTORY  
OF  
Arts, Sciences, and Manufactures.

---

CONJOINED SERIES.

---

No. CCLXXI.

---

RECENT PATENTS.

To CHARLES MAY, of Great George-street, Westminster,  
for improvements in the manufacture of bricks.—[Sealed  
1st August, 1853.]

THIS invention is chiefly applicable, though not wholly confined, to the making of perforated bricks; part of the invention being applicable for expressing and pressing brick earth when making and pressing other bricks. The invention consists in causing the brick earth to be expressed through orifices, or in moulds, by hydraulic pressure, in place of the means of pressure heretofore used; for which purpose it is preferred that the water should be constantly pumped into a vessel kept subjected to the pressure required,—the water being used at intervals for acting to press the brick earth through moulding orifices. The bricks are subsequently pressed in moulds, with pins or plugs to enter the several perforations, to improve the form and give compactness to the bricks; and, when moulding perforated bricks, parts of the moulds are prepared with pins, which, on being pressed into the brick earth in moulds, cause the same to be pressed and expanded so as to fill the moulds; thus producing pressed perforated bricks.

In Plate II., fig. 1, represents, in section, a reservoir of water under great pressure, or, as it is termed, an “accumulator,” to the ordinary hydraulic press, when used in the manufacture of bricks. *a*, is a hollow pillar on a base-plate *b*, (the outside of this pillar is turned accurately and smooth); *c*, is a strong cylinder with a cupped leather at *d*; *e*, the inlet pipe from the pumps; and *f*, the outlet pipe to the press: the whole



forming an inverted hydraulic press, intermediate between the forcing pump and the hydraulic press, which is to act immediately on the clay in the process of forming the bricks.

The cylinder *c*, is to be loaded with the requisite amount of weight that may be needful. It will thus be obvious to a mechanic that when the force-pump is put in action, the water or other fluid will pass through the pipes *e*, and *f*, into the hydraulic press, until the resistance to the movement of the ram of the press becomes greater than the force required to raise the cylinder *c*, and its load. The action required of the hydraulic press being then completed, a valve at *g*, is shut,—when the pump continuing in action, the cylinder *c*, continues to rise until it reaches the limit shewn by the dotted lines; at which point a valve opens to allow the fluid to pass off. But usually, before this point is reached, the press has been discharged and recharged; when the valve *g*, being open, the fluid from the cylinder *c*, discharges into the cylinder of the press so as to bring it up rapidly to its work; and by this means the force-pump may be continually going, and much time saved.

The second part of the invention consists in pressing perforated bricks, formed by expressing the clay through dies with a series of cores, such as are made under patents granted to Mr. Robert Beart, and which process is well known. These descriptions of bricks are taken when in a partially dried and tough state, and, if the surface is much drier than the interior, stacked together closely for a time, to allow the moisture to become more equally diffused, and the state of the substance homogeneous: each of such bricks is then placed in a mould, as shewn at fig. 2, a horizontal section of which is shewn at fig. 3. *h, h, h, h*, represents a metallic mould of the dimensions which the brick is to assume when pressed. *i*, is the cover of this mould, having fixed to it as many pins as there are holes in the unfinished brick. *k*, is a plate fitting in the mould, and having two or more standards *l, l*, passing through the cover of the mould *i*; and it has perforations corresponding with the pins in the cover, and capable of passing freely on them for the purpose of discharging a brick after it has received the requisite pressure. *m*, is the plunger, also fitting the inside of the mould; having in it perforations corresponding with the pins, and also cross perforations *m'*, to admit of clearing away any particles of dirt. The unfinished or unpressed brick being placed on the plunger *m*, the latter is forced up by any convenient mechanism, such as a lever, a screw, a cam,

or by hydraulic means; and, a sufficient force being applied, the plastic state of the clay admits of its being pressed so as accurately to fill the mould,—the pins preserving the form of the holes. The plate *k*, is then forced downward, through the medium of the standards *l, l*; the plunger *m*, is withdrawn; and the brick is discharged from the mould a perforated pressed brick, ready, according to its state and the nature of its substance, either to be placed at once in the kiln, or to be further dried before burning.

The patentee remarks that in the process of expressing the clay through the dies, before alluded to, it frequently happens that there is an imperfect cohesion of the clay in the substance between the holes; and that the object of this part of the invention is not only to give a better form to the exterior of the brick, but also to render a brick sound by producing a more perfect cohesion in the parts referred to.

The third part of this invention consists in making perforated bricks of clay reduced to powder, and in such state as will admit of coherence by pressure. For this purpose the clay or earth employed is so far dried as to be pulverulent, but not entirely free from moisture; and it is then pressed in a mould, as shewn at fig. 4; and in horizontal section at fig. 5. *h, h, h, h*, represent the four sides of the mould, which requires to be in depth about three times the thickness of the intended brick: the mould is a fixture. *m*, is a follower or plunger, to be acted upon from below, impressing the material, and having projecting pins *x, x, x, x, x*, the length of which is such as not to extend quite through the finished brick. *n, n*, is a hollow plunger also fitting the mould, and having holes for pins the counterparts of those in the follower *m*. These pins *y, y, y, y, y*, are attached to the end of an arm or connecting-rod *q*, fitting the inside of the plunger *n, n*. Between the inside of the plunger and the end of this connecting-rod is placed an elastic substance, or springs of metal, which serve, when the machine is at rest, to keep the inside horizontal surface of the plunger and the end of the connecting-rod somewhat separated.

In operating with this machine, the mould being open, and the plunger and the plate *k*, at the bottom of the mould being withdrawn, the requisite quantity of pulverulent or partially-dried clay is put into the mould. The connecting-rod is caused to force the plunger *n, n*, into the mould; and when the resistance of the substance in the mould is greater than that of the elastic medium in the space *o, o, o, o*, the connecting-rod forces the pins through the plunger to the

limit assigned The surfaces  $a^*$ ,  $a^*$ , of the pins being parallel and contiguous, and the surfaces  $b^*$ ,  $b^*$ , being slanting, it will be seen that their joint action tends to press the clay outwards horizontally,—thus consolidating the substance between the perforations, and assisting in making a clean surface to the brick.

The connecting-rod being now at rest, having performed the first compression, and being able to resist a great force, a second and greater pressure is brought from below upwards, through the medium of the follower  $m$ , and this completes the formation of the brick. The connecting-rod is now elevated; the elastic substance or springs  $o, o$ , keeping the plunger  $n, n$ , pressing on the upper surface of the brick until the pins are partially withdrawn, which prevents the edges of the perforations being broken up. The plunger is then carried up by the ascending of the connecting-rod, and the brick is ready to be discharged from the mould by the plate  $k$ , acted upon through the medium of the standards  $l, l$ ; and thus is produced a pressed perforated brick, having the holes of larger area inside than at the orifices; the advantages of which consist in saving material of the brick, and retaining a sufficient opening for the keying of the cement, without wasting the same.

In order to make perforated bricks of dried clay with parallel or nearly parallel perforations, a mould is used as represented at figs. 6 and 7, which is similar to the first-described mould, but inverted and deeper.  $h, h, h, h$ , is the mould;  $i$ , the bottom, to which are attached the pins;  $k$ , is a plate fitting the mould, with holes to admit the pins passing freely through;  $l, l$ , are lifters or standards passing through the bottom of the mould, and attached to the plate  $k$ ; and  $m$ , is a plunger, having holes to admit the pins, and cross perforations  $m^1$ , to admit of clearing out any dirt. A sufficient quantity of dried clay being put in the mould, the plunger is pressed down with sufficient force to consolidate it. The plunger then retires, and the plate  $k$ , being elevated through the medium of the standards  $l, l$ , the brick is delivered from the mould ready to be placed in the kiln for burning. In order to bring the dried clay to a proper state of moisture to cohere simply by pressure, as above explained, it is preferred to sift it from an elevation through an atmosphere charged with steam; by which means a proper degree of moisture is diffused through the mass.

The patentee remarks that he lays no claim to the hydraulic press as applied to making bricks; nor does he claim the

*Baker's, for Impts. in Moulds for Manufacturing Bricks. 5*

making bricks from pulverulent clay, both of which were described in the specification of a patent granted, in 1828, to Mr. Mencke (see Vol. ix., second series, p. 65); neither does he claim any particular combination of machinery for giving motion to the parts of the moulds described; but what he claims is, First,—the use of the accumulator as a means of saving time and power, in conjunction with an hydraulic press, in the manufacture of bricks. Second,—the use of moulds in combination with pins and apparatus as described, for pressing and forming perforated bricks.

---

*To CHARLES BAKER, of Southampton, merchant, for improvements in moulds for the manufacture of bricks.—*  
[Sealed 8th March, 1853.]

THIS invention relates to the manufacture of perforated or hollow bricks, and consists in forming the bottom of the mould with upright projections of the form it is intended to give to the perforations or hollows in the brick. On to this bottom the other part of the mould is placed. The brick earth is thrown and pressed into and struck off from the mould, as when moulding solid bricks. The mould and brick are then lifted from off the bottom of the mould, and the brick is delivered on to a board or pallet in the ordinary manner.

In Plate II., fig. 1, is a longitudinal section of the mould, and apparatus combined therewith, for making perforated bricks; fig. 2, is a transverse section thereof; and fig. 3, is a plan of the parts combined with the bottom of the mould. *a*, is the table or bench to which the bottom of the mould is affixed by screws *b*, or by other suitable means: *c, c*, are a series of upright projections carried by the frame *d, d*. In the arrangement shewn, there are six of these upright projections, and consequently each brick will be made with six perforations; and the projections shewn are rectangular; but the number of such upright projections and the form thereof may be varied. The frame *d*, is, with its upright projections, constantly pressed upwards by means of springs *e, e*, on the rods *f, f*; such rods being guided by passing through the holes in the frames *g, g*. In order to cause the frame *d*, and the upright projections *c*, to descend when a brick has been moulded, a connecting-rod or chain *h*, is attached to the frame *d*, and descends to and is connected with a treadle not shewn in the figure. In moulding bricks according to this invention, the workman places the upper part or side of

the mould *k*, in its place over the bottom of the mould, as when moulding ordinary or solid bricks; and before throwing in any brick earth the workman will have allowed the upright projections *c*, to ascend to their highest position; that is, level with the top of the sides of the mould; which position is regulated by nuts and screws placed on the ends of the rods *f, f*: he will then throw and press a quantity of brick earth (in a plastic state) into the mould, and will strike off any excess in the ordinary manner. The workman will next cause the upright projections *c*, to descend, by pressing down the treadle; and he will then deliver the brick on to the pallet, as when moulding an ordinary solid brick. By this arrangement it will be seen that the upper part *k*, of the mould is similar to those ordinarily employed, and is used in the ordinary manner of moulding solid bricks; and the peculiarity of the invention consists in the mode of applying the parts *c, d*, to the bottom of the mould,—whereby the moulded perforated brick is left in the mould by the receding of the upright projections *c*, out of the brick; so that the brick may be delivered from the mould on to a pallet, in the ordinary manner of brick making.

The patentee remarks that he is aware that perforated or hollow bricks have before been made by pressing brick earth through moulding orifices: they have also been made by pressing brick earth into moulds, having projections therein, so arranged, that the sides of the moulds, together with the projections, might be moved away; leaving the bricks, or the perforated pallets placed at the bottoms of the moulds, before introducing the brick earth into them. He therefore lays no claim thereto; but he claims the improvements in moulds herein described, for the manufacture of bricks.

---

*To RICHARD BRADLEY and WILLIAM CRAVEN, of Westgate Common Foundry, in Wakefield, in the county of York, engineers and ironfounders, for improvements in the moulding, forming, and compressing of clay, for the manufacture of bricks, tiles, and other earthenware.—[Sealed 1st July, 1853.]*

THE improved method of manufacturing bricks and tiles, forming the subject of the present invention, is described as follows:—A pug-mill, working with a vertical shaft, and set in motion by a power communicated through machinery of the ordinary kind, is placed over a horizontal circular table,

connected with the shaft of the pug-mill, and rotating with it. In this table are certain cavities or cells, into which moulds are inserted, of any required form or size suitable thereto, into which the tempered clay is supplied by the pug-mill. Upon the shaft of the pug-mill are knives or blades set at an angle, which revolve with the shaft and force down the clay in the cylinder of the pug-mill,—tempering it in the passage. At the base of the pug-mill, and at the lower end of the shaft, four other knives or blades are also set at a convenient angle, which work immediately over the face of the table, and, as they revolve with the shaft, force the clay into the moulds contained in the cavities or cells of the table, and effectually fill them in their successive passage under the mill.

To the several moulds, appropriate pistons are fitted with rods, having rollers, castors, or studs, at their lower extremities, and working through guides affixed to the under surface of the table. These piston-rods, by means of the rollers, castors, or studs, as the table revolves, travel up an incline constructed upon and attached to the frame of the machine, and thereby raise the pistons and press the clay into the moulds. The upward pressure, thus communicated, is met and counteracted by a flat plate of metal covering the upper orifice of the cavity or mould, and fixed to the frame-work of the machine, and of sufficient strength to resist such upward pressure. The angle of the incline may be altered at pleasure by screws or other like means for adjusting it, so as to increase or diminish the degree of pressure, according to the exigency.

The pressure having been thus effected, the pistons and rods, with their rollers, castors, or studs, descend, and, after proceeding for a short distance on the level, again ascend up a second incline, fixed to the same frame; and the cavities or cells being now removed, by the rotation of the table, from under the flat plate on the upper surface thereof, the last-mentioned incline forces up the pistons, which thrust out the moulded material from the moulds, and so prepare them for the reception of other material as they return to the pug-mill,—the pistons, in the mean time, descending, by a downward incline, to their original position.

To prevent any exudation or deposit between the table and the pug-mill, whereby the action of the machine might be clogged, and the dimensions of the moulded material altered, two or more rollers are affixed to the frame of the pug-mill, and support the table in its revolution, and are adjustable by

the mould *k*, in its place over the bottom of the mould, as when moulding ordinary or solid bricks; and before throwing in any brick earth the workman will have allowed the upright projections *c*, to ascend to their highest position; that is, level with the top of the sides of the mould; which position is regulated by nuts and screws placed on the ends of the rods *f, f*: he will then throw and press a quantity of brick earth (in a plastic state) into the mould, and will strike off any excess in the ordinary manner. The workman will next cause the upright projections *c*, to descend, by pressing down the treadle; and he will then deliver the brick on to the pallet, as when moulding an ordinary solid brick. By this arrangement it will be seen that the upper part *k*, of the mould is similar to those ordinarily employed, and is used in the ordinary manner of moulding solid bricks; and the peculiarity of the invention consists in the mode of applying the parts *c, d*, to the bottom of the mould,—whereby the moulded perforated brick is left in the mould by the receding of the upright projections *c*, out of the brick; so that the brick may be delivered from the mould on to a pallet, in the ordinary manner of brick making.

The patentee remarks that he is aware that perforated or hollow bricks have before been made by pressing brick earth through moulding orifices: they have also been made by pressing brick earth into moulds, having projections therein, so arranged, that the sides of the moulds, together with the projections, might be moved away; leaving the bricks, or the perforated pallets placed at the bottoms of the moulds, before introducing the brick earth into them. He therefore lays no claim thereto; but he claims the improvements in moulds herein described, for the manufacture of bricks.

---

*To RICHARD BRADLEY and WILLIAM CRAVEN, of Westgate Common Foundry, in Wakefield, in the county of York, engineers and ironfounders, for improvements in the moulding, forming, and compressing of clay, for the manufacture of bricks, tiles, and other earthenware.—[Sealed 1st July, 1853.]*

THE improved method of manufacturing bricks and tiles, forming the subject of the present invention, is described as follows:—A pug-mill, working with a vertical shaft, and set in motion by a power communicated through machinery of the ordinary kind, is placed over a horizontal circular table,

connected with the shaft of the pug-mill, and rotating with it. In this table are certain cavities or cells, into which moulds are inserted, of any required form or size suitable thereto, into which the tempered clay is supplied by the pug-mill. Upon the shaft of the pug-mill are knives or blades set at an angle, which revolve with the shaft and force down the clay in the cylinder of the pug-mill,—tempering it in the passage. At the base of the pug-mill, and at the lower end of the shaft, four other knives or blades are also set at a convenient angle, which work immediately over the face of the table, and, as they revolve with the shaft, force the clay into the moulds contained in the cavities or cells of the table, and effectually fill them in their successive passage under the mill.

To the several moulds, appropriate pistons are fitted with rods, having rollers, castors, or studs, at their lower extremities, and working through guides affixed to the under surface of the table. These piston-rods, by means of the rollers, castors, or studs, as the table revolves, travel up an incline constructed upon and attached to the frame of the machine, and thereby raise the pistons and press the clay into the moulds. The upward pressure, thus communicated, is met and counteracted by a flat plate of metal covering the upper orifice of the cavity or mould, and fixed to the frame-work of the machine, and of sufficient strength to resist such upward pressure. The angle of the incline may be altered at pleasure by screws or other like means for adjusting it, so as to increase or diminish the degree of pressure, according to the exigency.

The pressure having been thus effected, the pistons and rods, with their rollers, castors, or studs, descend, and, after proceeding for a short distance on the level, again ascend up a second incline, fixed to the same frame; and the cavities or cells being now removed, by the rotation of the table, from under the flat plate on the upper surface thereof, the last-mentioned incline forces up the pistons, which thrust out the moulded material from the moulds, and so prepare them for the reception of other material as they return to the pug-mill,—the pistons, in the mean time, descending, by a downward incline, to their original position.

To prevent any exudation or deposit between the table and the pug-mill, whereby the action of the machine might be clogged, and the dimensions of the moulded material altered, two or more rollers are affixed to the frame of the pug-mill, and support the table in its revolution, and are adjustable by



screws; the effect of which is to keep the face of the table close to the face of the pug-mill.

By these several processes, whilst the table continues to rotate, the material is forced into the moulds (which are thus completely filled), and there compressed and perfectly moulded, and thrust out when so moulded.

In Plate II., fig. 1, is a vertical section of the whole machine; fig. 2, is a plan, shewing the circular revolving table, with the moulds fitted into the cells, and the base-plate of the pug-mill and machinery; and fig. 3, is an end elevation, shewing the inclines for raising the pistons. *a*, is the motive machinery, adapted to steam or other power; *b*, is the pug-mill; *c*, is the pug-mill shaft; *d, d*, are the knives or blades on the shaft of the pug-mill; and *e, e*, are the knives or blades placed at a convenient angle, four in number, working immediately over the face of the table, and forcing the clay into the moulds. The gear, which connects the pug-mill shaft with the shaft of the revolving table, is shewn at *f*; *g*, is the shaft of the table; *h*, is the revolving table; and *h<sup>1</sup>, h<sup>1</sup>*, are the moulds fitted into the table. *i, i*, are the pistons fitted to the moulds; and *j, j*, are the piston-rods, working through guides in the table, and having rollers, castors, or studs, at their extremities. *k*, is the incline, first above mentioned, for pressing the material in the moulds; *l*, is the second incline, above mentioned, for forcing the moulded material out of the moulds; *m, m*, are adjusting screws to the first incline; *n*, is a descent in the incline, to relieve the pressure before the cell passes the edge of the plate *o*; *o*, is a strong plate, fitted close to the surface of the table, to prevent the material being thrust out of the cell by the action of the first incline *k*; *p*, is a scraper, to clear the surface of the table; *q*, is the frame, placed underneath, made of strong ironwork; and *r, r*, are the rollers, affixed to the frame of the pug-mill, for keeping the face of the table close to the face of the pug-mill.

The patentees claim the improved method of moulding clay by the machine above described, as a whole; and they claim separately, as new, the knives or blades at the base of the pug-mill; the fitting of the cavities with moulds; the raising of the pistons for pressing the clay in the moulds; and the rollers fixed to the frame of the pug-mill.

---

To THOMAS BROWNE JORDAN, of *New Cross, in the county of Kent, engineer, for improvements in machinery for planing slate.*—[Sealed 24th February, 1853.]

THIS invention consists in combining in the same machine two or more sets of cutters or tools of different characters, which act in succession on the plate or slab of slate to be planed, and produce thereon a smooth and even surface whilst passing once only through the machine. Two sets of tools are generally employed; the first set being composed of grooving cutters of the ordinary construction, and the second set of planing cutters, which are also of the construction commonly used. The depth to which these cutters are to work is regulated by means of a screw or other contrivance, which is arranged so as to act on the frame in which the cutters are mounted.

In Plate I., fig. 1, is a plan, fig. 2, a side elevation, and fig. 3, an end view of a slate-planing machine, having the working tools arranged according to this invention. *a*, is the foundation or bed-plate, furnished with rollers *b, b*, on which the moving table *c, c*, is supported and travels. The top surfaces of these rollers are adjusted to the same horizontal plane, and the bottom surfaces of the rails *d, d*, which are cast underneath the moving table, are planed truly parallel to the top of the table: the outer sides of these rails are also planed to suit the distance between the guide-surfaces *e, e*, of the bed-plate, so as to prevent any lateral motion of the moving table, and, at the same time, admit of its having perfect freedom of motion in a longitudinal direction. The traversing movement of the table is obtained by a screw, as shewn, or by a rack and pinion, or other equivalent arrangement. *f*, is the slab of slate being planed. This is operated on by the tools *g, g*, called the grooving-tools, and by the plane-irons *h, h*,—both sets of tools being mounted in the same bridge *i*, which is capable of sliding up and down between the standards *k*, when acted on as hereinafter explained. The grooving tools in front of the bridge form a series of grooves over the entire width of the rough slab; the extreme depth of all the grooves corresponding to the same horizontal plane, by previous adjustment of the tools. The cutting edges of the plane-irons are adjusted also to the same horizontal plane, but so as to cut a little deeper than the grooving tools, and thus remove all traces of the grooves, and at the same time clear away the parts between them,—leaving a perfect planed surface at one cut. The tool-bridge *i*, is raised

and lowered between the standards *k*, by the screws *l*, which work through nuts tapped in the bridge, and are turned by the bevil-wheels *m*, mounted on the shaft *n*, which is set in motion by the hand-wheel *o*. By this means, the machine can be adjusted for planing slabs of different thicknesses; but when it is employed on one particular thickness, the bridge is clamped to the standards by the screws *p*, and the tools have no movement whatever until that thickness of work is completed, or until they require sharpening. It will readily be seen that, according to these arrangements, the operation of slate planing can be performed with much greater despatch and certainty than by the usual methods adopted; all movement of the cutters during a course of work being avoided, and each slab finished on one side at a single stroke of the machine; while the power requisite to produce this effect can be readily obtained,—a large proportion of the resisting force of the material being destroyed by the grooving of its surface.

The patentee claims the employment, in slate-planing machinery, of two or more sets of cutters, brought into action successively on the material under operation, so as to complete a planed surface at one stroke of the machine.

---

*To CHARLES TROUPEAU, of Paris, in the Empire of France, for an improved diurnal reflector.*—[Sealed 8th November, 1852.]

THIS invention consists in using a metallic or glass mirror in diurnal reflectors,—sheets of copper, silvered or covered with a thin sheet of silver, being preferred. This mirror is fixed on wood or any other suitable substance, and placed in a suitable frame, in which there are grooves to insert a sheet of glass to protect the silver, or silvering, or the polished metal, from being tarnished by the atmosphere; or the polished sheets of metal may be covered with a transparent enamel adhering to it. Thus prepared, this reflector is placed in such a position as to catch the rays of light, and throw them into the dark place which it is desired to render light. The shape of the reflector, as well as the mode of attaching it, are necessarily varied, according to the nature of the place where it is to be set or fixed. The surface of the polished metal may be undulated in such manner as to spread the reflected light more: thus the undulations may be made in the shape of straight furrows, or inclined furrows, or of a great variety of other shapes, resembling a shell, or the rays of the sun. The metallic sheet being placed on wood, carved in the shape of the furrows or rays, gives it great solidity and beauty.

To EMILE CHAPPUIS, Fils, of *St. Mary Axe, London*, for an improved apparatus for the diffusion of light, to be called the *myriastratic reflector*.—[Sealed 20th April, 1853.]

THIS invention consists of improvements in what are called "daylight reflectors," or apparatus used for reflecting and diffusing the rays of the sun. It is well known, in the science of optics, that the degree of illuminating power possessed by any object or body, depends upon the intensity of exciting power in the luminous body, and the angle at which the rays of light fall upon the surface; and that certain metallic bodies reflect light in a high degree. Metallic reflectors have been employed for reflecting artificial light, and for reflecting and diffusing the rays of the sun; and these improvements relate to the latter species of reflector. It is found, that by covering the metallic surface of the reflector with a sheet or piece of glass, corrugated, fluted, ribbed, diapered, or figured, the reflective powers are increased, and, consequently, the light thrown by the apparatus into a dark place is more intense. The sheet or piece of glass corrugated, fluted, ribbed, or figured, should be so placed over the metallic reflector as to cross the corrugations or flutes in the metal at right angles. This arrangement produces an effect somewhat similar to that of the facets of a brilliant cut diamond; causing a refraction as well as reflection of light.

In Plate I., fig. 1, represents, in perspective, one of the improved reflectors, with the lower side open, to shew the internal arrangement of the corrugated metal and glass; and fig. 2, is a section, taken through the line A, B, of fig. 1. *a*, is a mahogany or other wooden case, one side of which, *b*, is made to open: the part *c*, of this side fits into the upper part of the case containing the metal and glass, and is covered or faced with India-rubber, leather, cloth, or other suitable material, for the purpose of excluding water, and, as much as possible, atmospheric air, and preventing their action upon the surface of the metal and glass plates. A plate of ordinary glass *d*, is fitted to the upper part of the case; and may be fastened in by putty, in the ordinary mode of glazing window sashes; or it may slide in a groove, cut for the purpose, in the sides of the case *a*: in some cases, however, this sheet of glass is dispensed with. Immediately below the outer glass *d*, is a groove *e*, formed in the sides of the case *a*: this is made to receive a sheet or plate of corrugated, ribbed, or diapered glass *f*, the lines or ribs of which run in a horizontal direction from side to side of the reflector. The metal

plate *g*, is formed of a thin sheet of silvered copper, placed upon a plate of zinc, or other suitable metal, to give it sufficient rigidity, and is fastened to a plate of zinc, by turning the edges of the silvered plate over upon the zinc; or it may be nailed or fastened to the wooden frame. The lines or ribs of the metallic plate run in a vertical direction, or at right angles to the lines of the glass plate *f*. It is immaterial whether the lines of the plate *g*, are vertical; they may be horizontal, and the ribs or lines of the glass plate *f*, vertical, so as to be at right angles with each other; but the former arrangement is preferred. A slight convexity is given to the metal plate *g*, as shewn in the drawing. The plate *g*, rests upon the raised portion *h*, of the case *a*. When the plates *f*, *g*, are arranged in their places, the case is locked, and will then be impervious, or nearly so, to air and moisture; or the case may be otherwise fastened without a lock.

The patentee claims the manufacture of a daylight reflector, wherein a sheet or piece of glass is used, having on the surface thereof ribs, corrugations, diapers, or other figures, as hereinbefore described and shewn. Also the peculiar construction of the frame thereof, which renders the reflector impervious to air and water, as hereinbefore described and shewn.

---

*To CHARLES REEVES, jun., of Birmingham, in the county of Warwick, manufacturer, for an improvement or improvements in swords.*—[Sealed 21st April, 1853.]

THIS invention relates to that part of the sword called the tang, to which the hilt and grip or handle are attached; and consists in making the tang of the same width, or nearly the same width, as the blade of the sword, and as it were a continuation of the blade. The handle of the sword is formed by attaching the material of which the handle is composed, on each side of the tang.

In Plate II., fig. 1, represents the tang end of a sword-blade, constructed according to this invention; and fig. 2, shews the tang end of a sword-blade constructed according to the ordinary method. The tang *a*, of the ordinary blade, fig. 2, passes through the handle and hilt,—the hilt bearing against the shoulder *b*; the positions of the several parts being secured by rivetting at *c*. In the improved sword, shewn at fig. 1, the part *d*, which passes through the hilt, and to which the handle is attached, is of the same breadth as the blade of the sword, or nearly so, and is a continuation of the

blade as represented. The handle is made of pieces of wood or other material, placed on each side of the part *d*, and attached by the holes *e*, *e*, or otherwise. The hilt shewn in dotted lines is secured in its place by the shoulder *f*, and cap *g*, shown in dotted lines. The cap *g*, is secured by the part *h*, being rivetted. By this method of construction, swords are made much stronger than by the ordinary method, and the risk of bending or breaking the sword at the point where the tang and blade join is avoided.

The patentee claims making the tangs of swords of the same or nearly the same breadth as the blades of the swords.

---

*To WILLIAM EDWARD NEWTON, of the Office for Patents, 66, Chancery-lane, civil engineer, for improved machinery for crushing ores and separating therefrom gold, silver, or other metals contained therein,—being a communication.*—[Sealed 4th November, 1853.]

THE object of this invention is, first, to crush or pulverize the quartz, or other ore containing the gold, silver, or other metal, to be extracted; and then to carry forward the crushed or pulverized ore through a mercury bath, or rather a series of mercury baths, whereby every particle of the metal will be retained,—leaving only the siliceous and earthy matters to be carried over at the exit end of the machine.

The machine consists of two principal parts; namely, first, the apparatus for crushing the ore or quartz. This part is composed of a set of rollers or cylindrical surfaces, to which an oscillating, undulating, vibratory, or rocking motion is communicated, instead of a simple rotary or rolling motion, as heretofore. By this means the ore is not only crushed, but well triturated, and the metallic particles are scoured and cleaned from the oxides, sulphurets, arsenurets, or other impurities with which they may be covered or coated; and which impurities, until they are removed, will prevent the after process of amalgamation from being carried on in a satisfactory manner.

The rollers, cylinders, or curved surfaces, are attached to the ends of levers, which have a vibratory motion imparted to them, so as to work the surfaces of the cylinders to and fro in concave chambers or beds.

The ore or quartz having been sufficiently pulverized and triturated, the next process is to separate the gold or precious

metal therefrom. This is effected by the amalgamating apparatus, which consists of any convenient number of cylinders, which may be toothed, jagged, or roughened on their surface, for the purpose of carrying forward the material to be operated upon; and which cylinders are made to revolve in chambers supplied with mercury, through which the amalgamating cylinders, by their rotation, carry the pulverized ore.

The ore, when placed under the first crushing-roller, is quickly reduced to a coarse powder, and then passes on to a second crushing-roller, where it undergoes a similar operation, and is still further reduced until it is brought to an impalpable powder; and, for the purpose of separating the metal from the impurities, the whole pulverized mass is made to pass, in a divided state, through a body of mercury contained in troughs or channels at the bottom of the concave chambers, as above mentioned. In order to assist the trituration of the ore, a stream of water is allowed to run through the machine. The amalgamating process will also be considerably facilitated by raising the temperature of the mercury, which is effected by means of steam or hot-water pipes, placed in the recess in which the mercury is lodged; or the lower part of the concave chambers of the amalgamating apparatus may be exposed to the heat of steam, hot air, or hot water, for the purpose of raising the temperature of the mercury. An opening is made in the side of the machine, in the mercury troughs or channels, for the purpose of drawing off or removing the amalgamated metals and supplying fresh mercury.

The finely-pulverized materials, consisting of earthy and extraneous substances, after passing through the amalgamating apparatus, are ultimately discharged from the machine, in a thin sheet or layer, and caused to pass over or through troughs supplied with mercury, for the purpose of arresting any small particles of metals that may have escaped amalgamation during the previous processes of pulverization, trituration, and amalgamation, above described.

The figure in Plate I, is a side elevation of the machine,—some of the parts being shewn in section. *a, a*<sup>1</sup>, are heavy rollers, cylinders, or segments, working on the concave cast-iron bed-plates *b*, and actuated by the connecting-rods *c, c*<sup>1</sup>, attached to the levers or arms *d*, which are fixed in the said rollers; and an undulating, vibrating, oscillating, and eccentric motion is, by means of these arms, communicated to the rollers *a, a*<sup>1</sup>; so that a perfect crushing, grinding, or trituration action is produced upon the quartz or other ore submitted

to the operation of the cylinders or segments. *e, e, e*, are sockets, in which the arms or levers *d*, may be placed. By moving the arms or levers *d*, from one of the sockets *e*, to another one, a fresh surface of the roller or cylinder may be brought into operation, for the purpose of crushing and rubbing the ore or quartz. This may be done when any one portion of the surface of the rollers, cylinders, or segments has been so far worn away as to render it desirable to change the position of the roller, cylinder, or segment. *f, f<sup>1</sup>*, represent the side or cheek-pieces of the machine, and which carry or support the bed-plates *b, b<sup>1</sup>*, and confine the motion of the cylindrical rollers *a, a<sup>1</sup>*, in a direct line. *g, g<sup>1</sup>*, are screens, of various degrees of fineness, through which the pulverized materials are made to pass. *h*, is a body of quicksilver, contained in a groove or channel below the second roller *a<sup>1</sup>*; and through which the pulverized quartz or ore passes, depositing a certain portion of the precious metal mixed therewith. The concave bed-plate *b<sup>1</sup>*, may be made and used without the mercury-chamber *h*, if thought desirable.

*i, i, i*, are pipes, into which steam or hot water is admitted, in order to heat the mercury at *h*, and render it more sensitive. A hole is provided in the cheek-piece at the end of the mercury-chamber *h*, (as shewn by the circle) by which the mercury or amalgam may be extracted. *k, k, k*, are three small cylindrical toothed rollers, which form the principal part of the amalgamating apparatus. These rollers are provided with projecting teeth at their peripheries, and each roller is carried on a spindle, having bearings in the cheek-pieces *l, l<sup>1</sup>*. The rollers are placed in the concave compartments of the cheeks *l, l<sup>1</sup>*, as shewn in figs. 1, 2, and 5; and, on the revolution of these rollers (each one being partially immersed in mercury contained in the concave compartments), all the crushed ore is carried, in a finely-divided state, through the mercury. *n, n, n*, are steps or ledges at the end of the machine, where mercury is placed; and over which all the refuse or tailings has to pass before finally leaving the machine. *o, o, o*, are apertures to draw off the mercury or amalgam at pleasure. *m*, is a chamber for heating the mercury contained in the concave compartments of the cheek-pieces, and is, for this purpose, supplied with steam, hot air, or hot water.

In operating with this machine, a quantity of quartz rock, or other ore, is regularly thrown into the main crushing-chamber at *x*, and, by a suitable arrangement, either of hopper or other convenient contrivance, a constant supply is maintained.



A stream of water is constantly admitted into the machine from the water-pipes *p*, and motion is communicated from the driving power through the connecting-rod *c*, to the roller *a*, and, at the same time, continued to the smaller roller *a*<sup>1</sup>, by the connecting-rods *c*<sup>1</sup>, *c*<sup>1</sup>: thus a continuous vibratory, undulating, or partial rolling, sliding, and rubbing action, is kept up, which not only reduces the ore into fine particles, but rubs or triturates the particles, so as to cleanse the gold or precious metal from any impurities with which it may be coated. The machine has an inclination in one direction; and the pulverized ore, being held in suspension by the agitated water, is passed through the coarse screen *g*, into the smaller concave bed-plate *b*<sup>1</sup>, where it undergoes a more perfect and finer pulverization and trituration. The action of the second roller *a*<sup>1</sup>, corresponds in effect with the larger one;—the coarse and fine particles of gold are here scoured, and some of them are caught in the mercury-chamber *h*. The ore, being now finely reduced, is carried with the current of water through the second and finer screen *g*<sup>1</sup>, into the amalgamator proper, where all the reduced ore (in a thin layer or flake) is forced through the heated mercury, by the slow movement of the toothed or fluted rollers *k*, *k*, *k*, which are made to rotate slowly by means of suitable gearing. The finest and most minute particles of gold are here amalgamated; and if any particles should have escaped the action of the toothed rollers, they will be caught on the ledges or steps *n*, *n*, *n*. The large cylindrical rollers are made hollow, and, by placing mercury in their interior, a good amalgamating action could be effected.

All auriferous ores are accompanied by iron, copper, manganese, lead, or some other metal, in the form of sulphurets, arsenurets, oxides, or with mica and talc. These compounds are what the Spanish miners call "malatella," and are a great source of annoyance and difficulty in the extraction of gold and silver from their ores; more particularly by the mercurial process (*i. e.* amalgamation), because the gold particles are coated with the oxide of iron, sulphuret of iron, or some other malatella, which causes them to resist the attraction of the mercury, which power would exist if the surface of the gold particles were bright and free from any extraneous coating. Another serious difficulty exists in the tales, micaceous slate, and iron, forming a greasy, oily, unctuous substance, which floats on the surface of the mercury. Should the mercury be broken up into minute globules, each one of these will be coated with this substance; thereby pre-

venting any affinity for the fine particles of gold which are disseminated throughout the ore. This is more particularly the case in the sulphurets, arsenurets, and especially in the ferruginous, ochreous, decomposed quartz, which is so rich on analysis; yet, with the shaking tables, whirling pans, rotating tubs, revolving basins, and balls, usually employed for extracting gold, this ore is found to yield hardly any gold.

The patentee claims, First,—the general arrangement and combination of parts above shewn and described, or any mere modification thereof, for the purpose of crushing and triturating ores, and separating therefrom, by means of amalgamation or otherwise, the gold, silver, or other metals they may contain. Also the use of cylinders, rollers, or segments of cylinders, working in concave bed-plates; such rollers, when put in motion, having a partial rolling, undulating, or vibratory movement, as described; producing thereby a triturating, sliding, and rubbing of the surfaces of the said rollers against the substance to be operated upon; and which motion crushes, triturates, and rubs or cleanses the quartz rock, or any other ore or material submitted to its action. Also the use and combination of the corrugated or toothed cylindrical rollers, with the concave chambers in which they revolve; such concave chambers being supplied with mercury, in bulk, for the purpose of amalgamation. Also the use and application of steam, hot air, or hot water, in pipes or chambers, for the purpose of heating the mercury, in order to assist the process of amalgamation.

---

*To THOMAS TAYLOR, of the Patent Saw Mills, Manchester, for improvements in apparatus for measuring and for governing the flow of water and other liquids.*—[Sealed 4th May, 1853.]

THESE improvements consist, firstly, in admitting liquids to meters through an orifice or orifices capable of expansion and contraction, so as to possess varying areas, for the purpose of rendering the action of the measuring apparatus more sensitive when a comparatively small quantity of the fluid is drawn off. Secondly, in an arrangement and construction of valve for governing the flow of fluids,—one point of novelty of which consists in forming the valve of metal, covered with gutta-percha, and fitting it to its seat by applying the gutta-percha in a plastic state; and another peculiar feature is the method by which a valve is opened and closed.

In Plate I., fig. 1, is a plan view, with the casing in section, of a meter constructed according to this invention; fig. 2, is a vertical section of the same; and fig. 3, is a detached view of one of the orifices by which the fluid is admitted,—the parts being shewn in two positions. The principle by which the measurement is effected, according to the construction of meter above referred to, is the rotation of a wheel provided with vanes, against which the fluid is caused to impinge, so as to effect its revolution. It is evident that, however accurate the construction, a force of fluid, beyond a certain amount, must impinge upon the vaned wheel, before a rotation can be effected, and consequently before a measurement will be indicated. Before this necessary action, therefore, can be obtained, a certain amount of fluid may be drawn off, without producing any effect; and although this quantity may be very small in reference to the construction of meter, it is yet desirable to reduce it: this is effected by causing the orifices to contract or expand by a self-acting process, according as less or more fluid is allowed to pass from the meter. In the figures above referred to, the rotatory drum or wheel *a*, is mounted upon a shaft within a casing *b*,—the fluid to be measured passing inward through nozzles *c*, connected with passages, as described in the specification of a patent, granted to the present patentee, 15th November, 1852; and to these nozzles the improved apparatus is attached. The passage *d*, by which the fluid enters, is provided with a valve or shutter *e*, turning upon a centre at *f*; and to this centre is attached a vane *g*, extending towards the centre of the drum *a*. The axle of the valve *e*, also carries an excentric pulley *h*, to which is connected one end of an elastic band *i*,—its other extremity, after passing over a pulley *j*, being attached to an arm *k*, which also carries the pulley *j*. By the elastic force, therefore, of this band, the valve *e*, when not forced outward, is kept to its seat within the nozzle *c*, so as to close the aperture, with the exception of a small orifice formed by a pipe *l*; which pipe extends outwards so as to deliver a stream of fluid at a point almost in contact with the vanes of the drum *a*. Suppose the parts to be in the position shewn at fig. 3, and that a small quantity of fluid be drawn from the metre,—to supply the place of this, a like quantity must pass therein; this will take place through the small orifice of the pipe *l*,—the valve being kept to its seat by the elastic band *i*; and as the pressure is thus concentrated, sufficient force will be exerted to turn the drum *a*, upon its axis, and consequently register the quantity of fluid used. The drum *a*, having been thus put in motion, and a more considerable quantity being

now drawn off, a circular stream of the fluid will take place, and by acting against the blade *g*, will turn the valve *e*, upon its centre, so as to open the full area of the passage *d*, as shewn in dots at fig. 3; and in order to provide for this motion, a slot *m*, is formed in the nozzle *c*, through which the pipe *l*, may pass. The patentee observes, that although he has described the improvement as adapted to a certain apparatus for measuring fluids, he desires it to be understood that he does not limit himself to such combination; for it may be applied to other arrangements in which it is desirable to register the drawing off of small quantities of fluid.

The second improvement is shewn as applied to a "stand-pipe," in the vertical section, fig. 4. To the upper part of the pipe is adapted a box *a*, within which is placed a valve *b*, turning upon a joint at *c*: this valve is formed of metal, to which a piece of gutta-percha *d*, is affixed, and having been made plastic by heat, is moulded into the seat *e*. To the metal plate of the valve is jointed a link *f*, connected to a short lever *g*, fixed to an axle *h*, one end of which passes through the box *a*, and is there provided with a handle *i*. By turning this, therefore, the valve will be lifted from its seat, and the fluid allowed to pass through the orifice *j*,—the pressure subsequently returning it to the closed position. This part of the invention is shewn as applied to a stand-pipe; but, if desired, the handle *i*, may be the lever of a float; or the same arrangement of valve may be applied in other forms for governing the passage of fluids.

The patentee claims, Firstly, as applied to meters,—the adaptation of apparatus capable of contracting and enlarging the induction orifice or orifices by the action of the fluid to be measured. Secondly,—as applied to apparatus for governing the passage of fluids, forming a valve by moulding gutta-percha in a plastic state on to the seat thereof. Also the method, above described, of raising valves to admit the passage of fluids.

---

*To CHARLES POOLEY, of Manchester, in the county of Lancaster, cotton spinner, for an improved mode of feeding machines for opening, cleaning, blowing, and scutching cotton and other fibrous substances.—[Sealed 13th May, 1853.]*

THIS invention consists in dispensing with the usual feeding apparatus used in machines for opening, cleaning, blowing, and scutching cotton and other fibrous substances, and in

making the current of air—created by the partial vacuum formed while such machines are at work—draw the cotton or other fibrous substances through a covered trough into the machine, to be there operated upon in the usual manner.

In the figure in Plate II., *a*, represents the outside of a machine for opening cotton, known as “Hardacre’s patent opener:” the interior of this machine consists of a vertical shaft, with radial arms, which act upon the cotton, as is well understood by cotton spinners. *b*, is a covered trough, which reaches from the upper part of the machine *a*, to the heap of mixed cotton supposed to be at *c*. The upper part of the end of the trough *b*, is open at *d*, to admit the cotton or other fibrous substance to be operated upon. When the machine is put to work, the partial vacuum created within it produces a current of air in the trough *b*, which draws the cotton or other fibrous substance (which is fed by the attendant at *d*), from the mixing heap to the machine. The action of the air on the fibrous substances in the trough tends to loosen or separate the fibres from each other; thereby delivering them in a fit state to be advantageously acted upon by the machine. The trough *b*, is shewn as being broken, as it may be made of any convenient length.

The above-described feeding apparatus is equally applicable to several of the machines known in the trade for opening, cleaning, blowing, and scutching cotton and other fibrous substances: it is less expensive than the feeding aprons generally employed for the same purpose; requires less manual labour; and presents the fibrous substances in a more fit state for being operated upon.

The patentee claims the feeding of openers, and other machines of the like nature, by means of a covered trough, in which a current of air is produced by the machine to be fed.

---

*To THOMAS ISAAC DIMSDALE, of Kingstown, near Dublin, for improvements in disinfecting sewage or other fetid matters, and in absorbing noxious gaseous exhalations.—*  
[Sealed 20th May, 1853.]

THIS invention consists in the employment of a peculiar kind of peat or peat-earth containing a salt or salts of iron or oxide of iron. The material is used either alone or mixed with hydrate of lime or other alkaline or earthy matter. This mixture of the peat alone is reduced to a granular powder before it is used. When impure gases, exhaled from sewers, grave-

yards, burial-grounds, or putrifying animal or vegetable substances pass through the prepared peat, all the ammonia and sulphuretted hydrogen will be absorbed by the peat, and decomposed. For deodorizing sewage, or other fetid, solid, or liquid matters, the powdered peat is mixed with the fetid matters alone, or in combination with the above-mentioned matters, and the noxious or unpleasant odours will be absorbed thereby. Or in places where gaseous exhalations, arising from sewage or putrifying animal or vegetable substances, exist, these noxious gases may be absorbed by merely spreading out a layer of the disinfecting material.

It may be necessary here to state, that peat or bog earth, both in its natural state or simply dried in the open air, as it is prepared for fuel, or when reduced to charcoal by burning, is well known to possess the power of absorbing certain effluvia which are generated during the decomposition of animal or vegetable matters. This knowledge, that peat or bog earth possessed these properties, has led to this substance being very generally and extensively employed, particularly in Ireland, where it is a common practice to use peat in its raw state, or air-dried peat combined with ashes and peat charcoal, to mix with manures, for the purpose of fixing the ammonia and other volatile gases which are evolved from them.

The result of some elaborate experiments, made and published in the year 1850, by Professor Davy and his son, in Dublin, goes to prove that the disinfecting power of peat and peat charcoal, is partly attributable to the presence of creosote in both these substances. Common peat has also been employed at Limerick, in the Works of the Hibernian Gas Company, for the purification of coal-gas, manufactured for illuminating purposes; and it was found to answer the purpose. It is likewise well known that the power of absorbing certain gases exists, to a greater or less degree, in some earthy matters,—especially in those of alkaline character, when calcined or torrefied; also in ashes, and in every kind of charcoal, whether animal, vegetable, or mineral. But charcoal made from peat or from any other substance, as well as simple peat or other earthy matter, raw or calcined, or torrefied, parts again freely with the ammonia taken up, upon being slightly heated.

The first part of this invention consists in the employment of peat containing a salt or oxide of iron, either naturally combined or mixed artificially therewith, by saturating it with a solution of a salt of iron, or any other metallic salt, or mixing it with any metallic oxide, either alone or in combination with alkaline, phosphated, or other earths, or coal-ashes or charcoal

of any description. The effect of these materials will be the absorption of the ammoniacal and hydro-sulphuric acid gas found in or evolved from the matter contained in sewage, in cesspools, and in all excrementitious and putrescent substances, and the deodorizing and disinfecting the same.

The same materials may also be employed for filtering and purifying water contaminated with fetid substances and gases, and for taking up the noxious gases exhaled from burial-grounds and vaults, as before mentioned.

The salt of iron found naturally in peat is the sulphate; and by the agency of this substance, ammonia is converted into sulphate of ammonia,—a non-volatile salt. The oxide of iron, separated by the ammonia from the sulphuric acid of the sulphate of iron, combines with and arrests the sulphur in the hydro-sulphuric acid gas (sulphuretted hydrogen). When the material containing the salt or oxide of iron employed as the purifying material, is charged with sulphur, the material may be renovated by simply exposing it to the action of the air, and thereby rendered capable of being again employed as at first. The sulphuret of iron is decomposed by this exposure to air, and the iron passes into the state of peroxide of iron, which is capable of acting upon a further quantity of sulphuretted hydrogen gas.

The sulphur separated from the sulphuretted hydrogen by means of the salt or oxide of iron, as described above, is inodorous and insoluble, and is entirely removed from the solid, fluid, or gaseous compound submitted to the purifying process. Sewage and other matters to be operated upon, vary in their character and components, and in the degree of strength in the latter; and if the quantity of ammonia present be not enough properly to decompose the salt of iron, the addition of an alkaline earth (lime or chalk is preferred) will effect the decomposition necessary, in order to enable the oxide of iron to set upon the hydro-sulphuric acid gas, and decompose it into its elements, as before stated. In artificially preparing peat, or the other substances mentioned, for the purposes of this invention, it is preferred to use the sulphate or muriate of iron as the best, the most easily obtained, and cheapest material for the purpose; or common salt may be used in combination with a solution of the sulphate of iron; but the hydrated oxide of iron alone will take up sulphuretted hydrogen. The salts and oxides of other metals will likewise accomplish the object in view; but not being capable of being re-oxidized with equal facility, are not so eligible for use.

In order to impregnate the peat or bog earth, and other

earthy matters combined therewith, as aforesaid, with iron or a salt of iron, any convenient quantity of peat earth, coprolite, or charcoal, or ashes of any description are sometimes employed, either alone or mixed with lime or chalk, marl, or fullers'-earth, and boiled in the water found in coal and other mines—provided such water is found to contain oxide of iron, or any salt of iron, as is generally the case. The water of these mines, so found charged with iron or other metallic matter, is sometimes used,—simply saturating the materials above described with such water, when evaporated, by boiling to an adequate strength; when they will become impregnated sufficiently with a metallic salt or oxide, and will accomplish the decompositions specified as above. By this process of boiling or macerating the peat or other materials in such water of mines, they become more uniformly and strongly impregnated with the metallic matter than the ferruginous peats found in nature; and the maceration of the peat, by dis severing its fibre, facilitates its being brought into that state of division best suited for the purposes of the invention. If naturally-ferruginous peat be employed, it must be broken, or ground into coarse powder, or reduced to a state of mould, to render it fit for application. For the deodorization of solid sewage or other fetid matters, the purifying material above described is to be strewn or spread over them, or mixed therewith; and the sewage water, or other fetid liquid, must be filtered through the purifying materials, and, in some cases, covered therewith. Powdered charcoal will float upon water; but when the media employed as the vehicle of the metallic salt or oxide are of a heavier nature than charcoal, they may be suspended over the liquid substance by mechanical means adapted to the place where, and circumstances under which, the operation of purifying and disinfecting is to be performed. In taking up the fetid gases emanating from burial places, it is merely necessary to strew the purifying material on the ground or surfaces whence the noxious gases exhale.

The patentee claims, in conclusion, the deodorization and disinfecting of solid or fluid sewage matter, and of other fetid substances, and the foul gases emanating from the same, or from burial places, by the use of peat or peat earth containing, naturally, a salt or oxide of iron, and brought into a state of pulverization in the manner hereinbefore mentioned; whether such peat or peat earth be used alone or mixed with chalk, marl, lime, or fullers'-earth, or with coprolite or common earths (raw or baked), common salt, breeze, or coal ashes, or peat charcoal, or charcoal made from bituminous shale of



any description. Also the preparation of common peat or peat charcoal, or charcoal made from bituminous shale, or from any substance whatsoever, breeze or coal ashes, and coprolite, by mixing, boiling, or saturating the same with a solution of a salt of iron or other metal, either artificially prepared or as found naturally in mines, or by mixing such earthy matters with the oxides of iron or other metals, for the purposes hereinbefore set forth.

To HENRI JOSEPH SCOUTETTEN, of Metz, in the empire of France, for an improved plastic compound, applicable to various ornamental and useful purposes.—[Sealed 21st May, 1853.]

THIS invention refers to the manufacture of a paste, composed of vegetable and mineral substances; the number and quantity of which varies according to the purpose for which the paste is required. Thus gutta-percha, caoutchouc, pitch, resin, wax, gum-lac, oxide of iron, golden sulphur of antimony, ultra-marine, chrome, zinc-white, &c., may be used.

Manufacture of the paste:—A steam-engine serves to furnish steam to two superposed hollow cylinders. These cylinders are themselves moved by the steam, crush the substances which enter into the composition of the paste, and form a homogeneous mass. Double-bottomed cauldrons, equally heated by steam, receive the matter, which, according to circumstances, may be heated dry or in hot water. When the paste is made, it is put into moulds and compressed, in order to produce the objects required. These moulds are composed of gutta-percha containing a twentieth part of caoutchouc: this process of moulding affords results hitherto unknown. Each mould should be bound with iron. This paste may also be composed chemically. In this case the gutta-percha, caoutchouc, and pitch, are dissolved in the sulphuret of carbon. When the solution is complete and the combination well effected, the solution is purified, the sulphuret of carbon is drawn off, and a mass is obtained, which may be heated dry in close vessels. If it be desired to make pipes, boot-soles, straps, &c., add to the above substances, held in solution in the sulphuret of carbon, carded cotton, all the portions of which are penetrated or exactly coated with the material. It is then purified, as in the former case, and a mass is obtained, which is heated dry and passed under rollers. Under other circumstances, and according to known processes, the cotton is replaced by linen, canvas, silk, wool, or

any other textile substance. The paste, thus prepared, may be coloured by adding one or more of the oxides indicated. When it is desired to render paper or stuffs impermeable, the caoutchouc and the gutta-percha must be separately dissolved in sulphuret of carbon, in the proportion of 8 of gutta-percha to 100 of sulphuret of carbon, well purified. The solution is left to rest during eight days, and the white of eggs is added to it. When the impure matters are deposited, it is poured forth to obtain an almost colourless liquid. Paper or stuff may be then steeped in this liquid, and drawn from it by passing the fabric between cleansing rollers, which equalize the layer of the matter. These stuffs become fit for all impermeable clothing. The paper, rendered impermeable, is suitable for photography; it is a substitute for parchment; and it serves for the preservation of valuable papers, to prevent their falsification, erasures, and the action of chemical agents. As the applications of the paste, they are innumerable: they comprise a complete moulding material, either for objects of art or utility; and in many cases may replace leather, pasteboard, plaster, carvings in wood, &c. The objects may be bronzed, gilt, or silvered.

---

*To PETER ARMAND LE COMTE DE FONTAINEMOREAU, of South-street, Finsbury, for an improved process for preserving milk, and its application to several organic products and alimentary substances,—being a communication.*  
—[Sealed 16th June, 1853.]

THIS invention consists in an improved method of treating milk and other organic and alimentary substances for the purpose of preserving them. Organic substances are subject to modifications both from the action of atmospheric air and reaction of their own constituent elements.

These modifications not only change their peculiar properties but often transform them into a variety of products far different from the bodies first constituting them. To preserve them it is necessary to protect them from the destructive influence of external atmospheric air, and to expel the air they may contain; and these objects are attained by forming a vacuum within the substances by an exhaust pump, by raising the temperature, or by these two means combined.

To operate upon milk, the air it contains is exhausted, by using a tube which is filled with milk, and put in communication with a reservoir containing a convenient quantity of that liquid, and covered with a layer of oil to preserve its ex-

posed surface from contact with the atmospheric air. When the operation is carried on with a larger number of vessels, it is more convenient to place them one upon the other, and to put the layer of oil over the milk in the upper reservoir.

To effect the expulsion of air from the milk, an air exhausting pump is adapted either to one reservoir or to two reservoirs. The connecting pipes must be directly under the reservoirs containing the milk, and not have any bend, which might prevent the free egress of the air therefrom.

When operating on a small number of vessels, it will be merely necessary to add to each of them a lead or tin pipe of sufficient length for containing a column of milk, through which the air can be expelled without causing the liquid to overflow; and in this case the layer of oil can be dispensed with. When the desired temperature is obtained either by *balneum mariæ* or by steam, and when sufficiently sustained, the tube is closed air-tight by means of pincers and solder,—care being taken beforehand to have the vessel entirely full.

To avoid the danger of the vessels bursting when the preserved substances are to be exported to hot climates, the pipe must be closed when the contents are at the same degree of temperature as that of the climate whither they are to be taken.

The vessels employed for preserving may be made of tinned or enamelled iron; but when the nature of the substances allows of glass being employed, that is preferred.

Solid and soft alimentary substances must be introduced into a reservoir containing a certain quantity of liquid covered with a layer of oil, as before described, to prevent the contact of the air with the liquid.

Meat, for example, cooked in gravy, and fruits boiled in syrup, can be preserved by this process with great facility.

The aperture of the tube is sufficiently large to allow the introduction of liquid matters; but when the substances are of a solid or heavy nature, they are introduced into vessels composed of two parts, which must be afterwards joined together.

The patentee claims the process of preserving milk and other organic alimentary substances, as hereinbefore described.

---

To JOSEPH LALLEMAND, of Besançon, in the Empire of France, chemist, for the manufacture of paper from peat.—  
[Sealed 5th August, 1853.]

THIS invention for the manufacture of paper from peat consists in treating peat or turf in the following manner:—It is

*Davis', for Distinguishing Genuine from Counterfeit Coin. 27*

first washed thoroughly, in order to separate all the earthy from the fibrous portions; and these latter are then placed in a bath of caustic ley. After a lapse of some twenty-four hours—more or less, according to the strength of the ley,—the fibres are removed, and are then placed, for about four hours, in a bath acidulated with hydrochloric acid, and kept constantly agitated therein. The fibres are next washed in fresh clear water, and are then subjected to a bath containing a small quantity of alum. After this, they are bleached in a chlorine vat, and subsequently mixed with from 5 to 10 per cent. of rag pulp: the fibres and pulp are then placed in an ordinary pulping engine, and the pulp goes through the processes usually followed in the manufacture of paper.

The patentee claims the manufacture of paper from peat, as hereinbefore described.

---

*To GEORGE DAVIS, of the City of London, for certain apparatus for distinguishing genuine from counterfeit coin.—*  
[Sealed 25th August, 1853.]

THIS invention consists of an apparatus especially adapted for use in connection with counters, shopkeepers' tills, and other similar receptacles, for the purpose of distinguishing genuine from counterfeit coins. It is found by experience that counterfeit coins are universally made of such metals or compounds of metals as are of less specific gravity than the corresponding genuine coins; such counterfeit coins have therefore to be made larger than the genuine coins, or to be of less weight. In order to detect the coins which exceed the dimensions of the genuine coins, or which fall short of the standard weight, the patentee constructs an apparatus, with a gauge-plate of convenient size, to receive a certain number of slots or oblong perforations, in such manner that one perforation may correspond to every common current coin of the realm, or to as many as may be convenient, according to the established system, or any which may hereafter take its place: that is to say, one perforation is to correspond to sovereigns, and the said perforation to be of such length and breadth as may readily allow a sovereign to pass through it, but no larger coin; and, near the under surface of the gauge-plate, a balance or weighted lever is suspended, one arm of which passes under the perforation, so as to receive the coin placed edge-ways therein, and is held up against the perforation by the weight of the other arm; which weight is so adjusted that it

shall not counterbalance a genuine sovereign placed on the receiving-arm, but shall allow it, by the action of its own weight, to bear down the receiving-arm, and roll off into the till or other receptacle under the gauge-plate; while a spurious coin shall be prevented from passing through and detained above the gauge-plate by the counterpoising weight which keeps up the receiving-arm. In like manner perforations are formed corresponding to the other denominations of coin for which the apparatus is employed.

In Plate I., fig. 1, represents a front elevation of the improved apparatus for distinguishing genuine from counterfeit coin; fig. 2, is a sectional end view; fig. 3, top or plan view; and fig. 4, longitudinal section, shewing the mode in which the coin enters, and the action of the balance or weighted lever. In each figure *a, a*, is the box or case for receiving the coin; *b, b*, the slope for discharging the same into any suitable receptacle; *c, c*, the gauge-plate; *d*, a crown-piece perforation; *d*<sup>1</sup>, a corresponding balance or weighted lever; *e, e*<sup>1</sup>, half-crown-piece perforation and weighted lever respectively; *f, f*<sup>1</sup>, perforation and balance for the florin or two-shilling-piece; *g, g*<sup>1</sup>, the same for the shilling; *h, h*<sup>1</sup>, for the sixpenny-piece; *i, i*<sup>1</sup>, for the fourpenny-piece; *k, k*<sup>1</sup>, for the threepenny-piece; *l, l*<sup>1</sup>, for the half-sovereign; and *m, m*<sup>1</sup>, for the sovereign. *n, n*, is the receiving-arm of the balance; *o, o*, balance-arm bearing; *p, p*, cylindrical weight; and *q, q*, tap or screw for adjusting the same when required. The action of the apparatus will be readily understood from fig. 4, which represents a sixpenny-piece placed edgewise on the corresponding perforation, which, being of the standard weight, bears down the receiving-arm of the weighted lever underneath it, and is thereby allowed to roll off and fall into the hand or other receptacle; whereas, a light coin would have been detained above the gauge-plate by the action of the weighted lever; while a coin exceeding the due size could not have entered the perforation. The edges of the perforations may be provided, if necessary, with small friction rollers to prevent the detention of the coins having milled edges. It remains to be noticed that the receiving-arms and weighted arms of the levers, which are here shewn succeeding each other alternately on each side of their bearings, may be otherwise, and that the perforations may stand in a single row or in other positions, and that the gauge-plate may be inserted in the lid of a till or counter, so as to transmit the money directly thereto without the intervention of the box *a*, and case *b*: the great object of the apparatus being to test the

soundness of the coin without an offensive display of the gauging and weighing processes.

The patentee claims the construction and employment of an apparatus for simultaneously gauging and weighing coins, in the manner and for the purposes hereinbefore described and set forth.

---

*To FRANCIS WHISHAW, of John-street, Adelphi, in the county of Middlesex, civil engineer, for an improved lock, or system of locks.—[Sealed 29th January, 1853.]*

THIS invention consists in fastening and securing doors, shutters, and similar things, by means of electro-magnetism, applied as hereinafter mentioned, so as to constitute an electro-magnetic lock, or system of electro-magnetic locks. The simplest form of electro-magnetic lock consists of a plate of soft iron, with an even surface on its exterior, and fastened by countersunk screws, or otherwise, to the inside of the door, &c., to be secured. Opposite to this plate is fixed an electro-magnet on the jamb-frame, lining, or the solid wall, as the case may be; so that when the door, &c. is closed, the surface or surfaces of the pole or poles of the electro-magnet may be in contact with the surface of the keeper-plate. On a current of electricity being passed, by means of properly insulated copper or other metallic wires or ropes, from a galvanic-battery to the magnet, the electro-magnetic locking is effected, and the door cannot be opened until the electric current is broken. This operation of connecting and breaking the current, or, in other words, locking and unlocking the lock, may be effected either near to the door so locked, or at any convenient distance, according to the position and power of the battery, the length of the wires, and other circumstances of each case, as will be at once understood by all persons conversant with electric batteries, keys, and other arrangements for making and breaking circuits.

Another mode of applying this invention is by using the bolt of an ordinary lock, or an ordinary bolt, as the keeper-plate; the magnet being placed opposite the bolt, so that the surface of the bolt, when shot forward, shall be in contact with the surface or surfaces of the pole or poles of the magnet; and when the current is on, the bolt and the magnet will be so strongly attracted to each other, that the bolt cannot be drawn back by the application of the key or ordinary force applied by hand to move such bolt.

It will be obvious that a great number of locks may be

placed in one and the same circuit, so as to be locked and unlocked by the making and breaking of the contact; the power of each lock to resist the opening of the door depending on the power of battery employed, and other circumstances which are well understood. The keeper-plate may be affixed to the jamb, and the magnet to the door; but the arrangement first described is considered the most convenient.

The patentee claims a lock, or system of locks, fastened and unfastened, on making and breaking the electric circuit as above described.

---

*To EBENEZER NASH, of Duke-street, Lambeth, tallow-chandler, and JOSEPH NASH, of Thames-parade, Pimlico, chemist, both in the county of Middlesex, for improvements in the manufacture of wicks.*—[Sealed 28th May, 1853.]

THIS invention consists, first, in the preparation of flax, hemp, and such like fibrous materials, by treatment with alkalies, either caustic or carbonated, and fermentation, and treatment with acids, chlorides, or other usual bleaching agents, for the purpose of making wicks for candles and lamps; second, the manufacture of wicks for candles and lamps, of flax, hemp, and such like fibrous materials that have been so prepared, and in the manufacture of compound wicks, consisting partly of such substances so prepared, and partly of cotton, in varied proportions.

In carrying out this invention, the first process of treatment for flax, hemp, jute, tow, and such like fibrous materials, in their raw state, consists in boiling them in a solution of carbonate of soda or potash, of any convenient strength, for several hours, or until all the mucilage and other vegetable matters, soluble therein, have been extracted; when the materials are to be taken out and well turned about in a souring steep of very diluted muriatic acid, to neutralize the alkali and dissolve any removeable trace of lime or other matters soluble in the weak acid; and, afterwards, they are to be well washed with a copious supply of clear water, preparatory to the second process of further treatment.

For the second operation of alkaline treatment, the materials are to be boiled from six to eight hours in a strong solution of caustic alkali (either potash or soda), of about the specific gravity of 1·050, which is considered a convenient strength.

One object of this caustic alkaline treatment is the extraction of silic from the fibre (as well as other matters soluble

in caustic alkali); and, in order to ascertain this, a sample of the fibres may be taken out and well washed with hot water, and then boiled in a test solution of caustic alkali of known purity, and the clear liquor neutralized with pure muriatic acid for indicating the presence or absence of silicic acid, which, if present, will render the clear solution slightly turbid or opalescent, according to degree.

Upon the completion of the caustic alkaline treatment, the materials are to be washed with clear soft water until all soluble matters are removed, and then they are to be well turned over in a souring steep of dilute muriatic acid, and afterwards well washed with clear soft water, until all traces of acid and soluble matters are removed.

For bleaching the purified fibres, the alkaline hypochlorites are preferred. But, if the common chloride of lime is used, especial care must be taken to prevent or remove any insoluble combination of lime with the fibres, by means well understood; and for which purpose nitric acid, or pure muriatic acid, in a fit state of dilution, is preferred, as a final souring steep; concluding the operation by copious washing with clear soft water. Or, instead of using an alkaline carbonate, in the first instance, with these fibrous materials, in their raw state, they may be steeped in water, maintained at a fermentive temperature; and fermentation may be accelerated by the addition of a little yeast, in order to the removal of the mucilage; when the fibrous matters should be well washed with hot water preparatory to treating them with caustic alkali. But the treatment first described, by carbonated alkali, is preferred for this purpose; which is, however, unnecessary for thread, yarn, or textile fabrics, or the fibre, in any manufactured state, wherein the mucilage has been removed: in that case the caustic alkaline treatment is to be considered as the only alkaline treatment directed. The caustic alkaline treatment might also be used in the first instance, even in the raw state of these materials, without using either the alkaline carbonate or previous fermentation. The alkaline carbonates might also be used alone, without the use of caustic alkali; or a mixture of caustic and carbonized alkali, or crude potash, or crude soda ash, or solution of ammonia may be used with some effect, by producing partial purification of the fibres, so as to render them more suitable for wicks than when in their crude state; but using caustic alkali, in the second instance, as described, is preferred.

The second head of this invention relates to the application of flax, hemp, jute, tow, and such like fibrous materials,



after they have been purified or rendered suitable by the processes before described, or by any modification of treatment equivalent thereto, either as a substitute for cotton or in conjunction with cotton, either treated in the same way or not, as wicks for candles and lamps. For this purpose they are to be spun into threads, and twisted, plaited, or woven, in the usual way; in which state they may be used without other treatment, or they may be steeped in a solution of perchlorate of potash.

As an important feature of the method of treatment consists in the removal of the mineral or earthy matters, as well as the vegetable impurities, from these specified materials, as far as can be effected by chemical treatment, without destroying the integral properties of the fibre, so as to obtain a purified substance, capable of sustaining illumination by gradual combustion, as candle and lamp wicks,—special regard being had to the removal of the silix and other inorganic matters, and the careful avoidance of the common sources of contamination with lime in the selection and application of the chemical agents employed, in order to render these materials fit for the manufacture of the improved wicks,—the workman's attention is therefore directed to the following particulars, as involving points of importance to the attainment of the best result:—

The alkaline silicates precipitate mucilage in an insoluble state of combination: lime precipitates silix from its alkaline solution; and this compound is capable of forming a triple insoluble combination with mucilage and resinous matter: hence the advantage of removing the mucilage and resinous matter, in the first instance, by a separate process; and for which it is preferred (as before stated) to use the alkaline carbonates which have no action on the silix, in order to prevent any combination of the silix with the mucilage, by removing the vegetable impurities, first, by means of the carbonated alkali, and afterwards removing the silix, in a soluble state, by means of caustic alkali; for which intensity of action is preferred, by using strong solutions of caustic alkali, to the more gradual effect of weaker solutions.

The proper consideration of the object of thus dividing the alkaline treatment into two separate operations, will indicate the duration or repetition of the first process, and the necessity of copious washing for its completion, previous to submitting the materials to the second operation; and, as the alkaline carbonates have no injurious action on the fibre, the strength and proportions of the solution, in the first operation, are left to the operator's discretion.

Although a method is described of testing the completion of the second or caustic alkaline process, in order to ensure the attainment of a special object, that of the removal of the silix, yet these directions do not constitute a necessary part of the process, as the operator's experience may be sufficient to determine the duration of the treatment; and by maintaining the solution of caustic alkali in an active state, to the end of the operation, the intended result may be ensured.

As the alkalis are not rendered perfectly caustic without using an excess of lime, it frequently happens that the solution contains lime; but, as the presence of a little carbonic acid is much less objectionable than any trace of lime, this inconvenience may be prevented by proper attention in the preparation of the solution.

While the use of muriatic acid is mentioned as being the best for the souring steeps, which may be used at the usual strength, or slightly stronger than the souring steeps used for textile fabrics, other acids might be used for this purpose; with a similar effect; but the use of muriatic or other acids, which form soluble salts with lime, are preferred to those acids that form insoluble salts with lime, in order to avoid any combination of lime with the fibre.

All substances of vegetable growth contain a certain amount of mineral and earthy matters, which exist in these specified materials in such degree as to render them comparatively unfit for wicks; but if removed by the treatment described, as far as is practically consistent with the integrity of the fibre, which is stronger in texture and longer in staple than cotton, these purified fibres will, when arranged in a wick, perform the necessary function of capillary attraction in the most perfect manner.

The patentees claim the use and application of flax, hemp, and such like fibrous materials, rendered suitable by preparation, or that may have been rendered suitable according to the treatment described, or by any modification thereof, or by any treatment equivalent thereto, for the manufacture of wicks for candles and lamps.

---

To HENRY CONSTANTINE JENNINGS, of Great Tower-street, in the City of London, for improvements in the manufacture of soap.—[Sealed 2nd May, 1853.]

This invention consists in converting stearine into soap, by means of a carbonated alkali, with heat, instead of employing

a caustic ley or alkali together with long boiling. In combination with stearine obtained from palm oil, the patentee uses tallow, or any other vegetable or animal substance that yields stearine, such portions of common fat, or rosin, or other substance or substances, when desired, as shall tend to cheapen and produce the more common kinds of soaps. The result of the process is to obtain a harder and more neutral soap, and at a less expense.

Process:—"Combine one thousand pounds of stearic or margaric acids, as free from eleain or oleaine as possible, or palmatine, or any vegetable or animal stearine, or margarine, at the temperature of 212° Fahr., with a solution of bicarbonate of potassa, or soda; which solution shall have a specific gravity of about one thousand five hundred degrees. Constantly stir or mix until an intimate combination is obtained, and that the elements will not part when tried upon glass, or any other similar substance (which will possess on or about 6 $\frac{1}{4}$  per cent of alkali). When the mass is cooled down to about 60° Fahr., add 1 lb. per cent. of aqua ammonia, of about eight hundred and eighty degrees specific gravity, and 1 lb. per cent. of the strongest solution of caustic potassa: these are to be added gradually, and fully mixed or stirred, until perfectly combined. Dissolve 15 to 18 lbs. per cent. of common rosin of commerce, by boiling it with a solution of sub-carbonate of potassa, and common soda of commerce, in equal parts, or as much as will give the solution a specific gravity of or about one thousand eight hundred degrees when boiling hot. Mix these perfectly with the above-recited stearic or margaric acids, and carbonated alkali, as recited; then add a strong solution of caustic potassa, or soda, until a perfect saponification is produced. The dose of caustic alkali will much depend upon the purity of the stearine or margarine employed. The separation is now effected by using common salt, or sulphate of soda, &c., as is known and practised by soap manufacturers."

If the soap intended to be produced is to be colorless, no rosin must be employed, and a larger dose of aqua ammonia and caustic alkali must be used, according to the dryness of the stearic matter to be operated upon.

The patentee claims the use of carbonated alkalies, whether vegetable or animal, in combination with stearine or margarine, palmatine, or any other similar substance whatever, and aqua ammonia, for the production of soaps, and effecting saponification at a low temperature, by these combinations.

---

To JOHN DEARMAN DUNNICLIFF, of Hyson Green, in the county of Nottingham, lace manufacturer, and JOHN WOODHOUSE BAGLEY, of Radford, lace manufacturer, for improvements in the manufacture of lace fabrics.—[Sealed 11th August, 1853.]

THIS invention has for its object the production of lace fabrics, such as are now known as "Honiton lace" and "Honiton sprigs;" which fabrics, it is well known, are produced in sections or parts, by hand, on the pillow. These sections or parts are generally of comparatively small size, and are joined by hand, so as to produce more complex patterns. Each of the parts is in its outline edges or selvages complete; and consequently the selvages or edges of articles produced by compiling numbers of such parts or sections, are true and good; and such parts or sections of lace fabric are also extensively used for ornamenting plain bobbin net or twist-lace, made by machinery. Now this invention consists in manufacturing lace fabrics in twist-lace machines in sections or parts, varying in width in their different parts, with true or fast selvages; and for this purpose, the mode of manufacturing twist-lace described in the specification of a patent granted to the present patentees 11th June, 1850, is employed; but other modes of working twist-lace machinery may be resorted to in carrying out this invention. The machinery (in place of making breadths of lace, as heretofore, complete and suitable to be worn) is caused to work to produce only parts or sections of the intended articles,—each such part or section being in varying widths, according to the effect it is desired that each section should produce when made up,—whether the parts of a section are alternately to form stems or sprigs, or other parts of the pattern. The selvages or edges, both in the narrower and wider parts of the same section, are made fast, so that when arranged and joined up into more or less extensive and complex patterns or devices, the outer edges, and the edges of all the open parts, are fast, as in Honiton lace or Honiton sprigs.

In manufacturing narrow fabrics in twist-lace machines, suitable for being made up by hand into Honiton lace and Honiton sprigs, such fabrics must differ from those heretofore made in such machines; as those ordinarily made are, for the most part, if not wholly, unsuited for the carrying out of this invention; for they are not only too wide, but they are also not so made of different widths at intervals in their lengths, as to suit them for constituting many of the sections or parts

of patterns of Honiton lace and Honiton sprigs. It should be understood, that in making up such manufactures from narrow fabrics made in twist-lace machines, parts of the narrow fabrics require to be made of different widths at intervals: some parts require to be (in respect to other parts) comparatively wide; such, for instance, as the parts which are to form leaves or flowers, or parts of leaves and flowers, and wider parts of the device; whilst other parts require to be comparatively narrow, for making the stems and narrower parts of the pattern; and, in like manner, in other devices or patterns, some of the sections are also required to be comparatively wide and narrow, for making up the different parts of such fabrics. In these respects it is desirable that the machine-made narrow fabrics should, as nearly as may be, follow the widths and varying widths, and also the outlines or forms of the narrow fabrics made by hand on the pillow; and although there may be, in making up some patterns or devices of Honiton sprigs or Honiton lace (when using machine-made twist-lace fabrics), a considerable quantity of a uniform width of fabric used, still, without having fabrics of different widths and narrow fabrics wherein the width varies at intervals, very little can be done in getting or forming diversity and variety of patterns and devices. And although very narrow machine-made fabrics (that is, fabrics of widths, such as are made by hand on the pillow, whether with purled edges or not, and whether composed more or less of close weaving or meshes), may, when of a similar width from end to end, be used in making up Honiton sprigs and Honiton lace,—still, it is necessary to have in such manufactures, fabrics made of different widths at intervals in their length, so that the same length of fabric may go to make up wide and narrow parts of a pattern or device, as has heretofore been the case in regard to fabrics made on the pillow by hand, for the purpose of being made up into Honiton lace or Honiton sprigs. For this purpose, when producing fabrics in twist-lace machines, suitable for making Honiton sprigs and Honiton lace, in place of making the fabrics of the same width from end to end, each with at least one straight selvage, as has heretofore been the case with lace fabrics which are to be worn as they come from the machine,—the machines are caused to be soworked, that each breadth made in the machine shall have fast edges or selvages at intervals, if its length be varied in width. The best means of doing so is to vary the tension put on the warp threads, at such intervals as the workman may determine on; which may be aided by leaving out or calling into action some of the threads of a

breadth, as was described in the specification of the above-mentioned former patent. Thus, supposing a twist-lace machine to be "on with" a series of very narrow breadths, whether composed of more or less of close weaving or meshing; and supposing that the widest parts of the several breadths of fabrics have been for a time making,—if the workman gradually add weight or otherwise produce greater strain on the warp threads, each breadth of fabric (or such of them as have such additional strain or weight) will progressively become contracted in width till the greatest strain is obtained; and so long as the narrowest width of fabric is desired to be made, the greatest strain is to be retained. When the wider fabrics are required to be again produced, the weight or strain is to be reduced, until the width desired is again obtained. In this manner may the desired variation of widths in the same fabrics be obtained; and the fabrics will not be simply girt in at one selvage, but at both selvages into the middle, though in some cases it will be found desirable that the girting-in shall be only at one selvage, towards the other selvage, which may remain straight; for which purpose the additional tension, when narrowing, will require to be applied to only part of the warp-threads of each breadth. And it is the making of narrow fabrics, such as above described, in twist-lace machines (which, in the form they are produced in the machines, are not suitable, or little suitable to be worn), and their application to the making of Honiton lace or Honiton sprigs, which constitutes the peculiarity of this invention.

---

To WILLIAM HUNT, of *Lee Brook Chemical Works, near Wednesbury, in the county of Stafford, manufacturing chemist, for certain improvements in manufacturing sulphuric acid.*—[Sealed 16th August, 1853.]

THE ordinary mode of making sulphuric acid is to burn brimstone or sulphury pyrites, in order to obtain sulphurous acid gas, which is subsequently converted into sulphuric acid, by the addition of oxygen obtained from any suitable source.

The oxygen has usually been obtained from nitrate of soda or nitrate of potash, of which a large quantity is required to be decomposed to yield nitrous gases, to mix with the sulphurous acid gas: atmospheric air is also introduced, to facilitate the formation of sulphuric acid. These various gases are conveyed along flues, in order to be cooled, and pass from thence to the vitriol chamber, where the sulphuric acid is

condensed. The quantity of nitre used for this purpose forms a considerable part of the expense incurred in manufacturing sulphuric acid; any means, therefore, of economizing this article, will, of course, materially reduce the cost of manufacture.

The sulphuric acid obtained from sulphury pyrites, is found to contain arsenic; and it is well known that such acid, so contaminated, cannot be used in some of the arts, such as preparing iron for tinning and galvanizing.

Now these improvements are intended, first, to obviate the necessity of using so large a quantity of nitre as is usually employed in manufacturing sulphuric acid; and, secondly, to extract the arsenic from sulphuric acid, so that it may be more applicable to the various purposes for which it is usually employed.

In carrying out this invention, sulphurous acid gas and atmospheric air are passed through a hot chamber or flue made of brick or other suitable material, and, if thought desirable, filled with pebbles or pumice-stone, or any other material that will resist the action of heat and acid. This flue or chamber, and materials contained therein, are heated by means of the heat given off from the furnace while burning the sulphury pyrites, from which the sulphurous acid gas is obtained. The sulphurous acid gas, together with the atmospheric air, are caused to pass through this heated chamber, which is made nearly red hot. By this means part of the sulphurous acid gas will take up oxygen readily from the air, and become converted into sulphuric acid, which is carried forward with some sulphurous acid into the vitriol chamber, or to the condensing column hereinafter described, where it is condensed. The remaining sulphurous acid will also become mixed with nitrous gas, which is supplied for the purpose. By this means a great economy of nitre is effected, as a considerable quantity of sulphuric acid is made in the hot chamber or flue by the combination of the oxygen of the atmosphere with the sulphurous acid. Hitherto the gases have been cooled down in flues as they were generated, and not passed through a hot chamber: the consequence of which is that the oxygen of the air will not easily combine with the sulphurous acid, as this combination only takes place with avidity when the gases are highly heated.

A large saving of nitre may also be effected by causing the sulphurous acid gas and atmospheric air to pass through a brick flue or chamber filled with the former mentioned materials, and heated by the spare heat arising from the manufac-

ture of coke, or from other ovens or furnaces. By either of these means the heat required to promote the combination of the oxygen of the air with the sulphurous acid, is obtained from sources where it would otherwise be wasted. The above gases, by percolating through the heated materials, become converted into sulphuric acid gas, which, being cooled after leaving the flue, and brought in contact with water, will be rapidly absorbed, and become converted into liquid sulphuric acid.

In Plate II., fig. 1, represents, in longitudinal section, a furnace constructed to burn coaly pyrites, and generating sulphurous acid gas therefrom. Fig. 2, is a transverse section of the same. *a, a, a,* is the masonry of the furnace; *b, b, b,* the fire-bars or grating on which the pyrites are placed; *c, c, c,* are ash-pits, through which the dust resulting from the burning of the pyrites falls, and may be cleared out from time to time through the side doors *d, d, d.* The furnace is charged with pyrites by the door *e,* (fig. 1,) in front; and air to support combustion, and also to supply oxygen to carry on the conversion of the sulphurous acid into sulphuric acid, is supplied through a door, or hole below the furnace door communicating with the ash-pits. As the sulphur from the pyrites is driven off therefrom, and becomes converted into sulphurous acid gas, the exhausted pyrites are pushed forward along the grating towards the end to make room for a fresh supply; and to facilitate this operation, side doors *g, g, g,* are placed on the side of the furnace, so as to enable the workmen to stir and push forward the burnt and exhausted pyrites; and when the mass has been deprived of all its sulphur, it is finally pushed into the well *h,* from whence, when cool, it may be removed in any convenient manner. The heated gases pass from the furnace along the flue *i, i, i,* made above the fire; and by this means the gases are made exceedingly hot, and caused to combine with the oxygen of the air supplied to the furnace, and thereby produce sulphuric acid. This flue or chamber may, if thought desirable, be supplied with pebbles, stones, or other substances, through or between which the gases will be made to pass, and thereby be more effectually commingled. By thus placing the flue or chamber *i, i,* above the furnace, the heat of the latter is made more uniform than it otherwise would be, and will more effectually burn the carbonaceous matter contained in the pyrites: and as a considerable portion of the sulphurous acid gas will be converted into sulphuric acid in the furnace, a less quantity of nitre or nitrous gas than usual will be required.



If it be proposed to use a vitriol chamber in connection with this apparatus, the gases are conveyed away from the flue *i*, through the opening *j*, (fig. 1,) direct to the vitriol chamber, which must be supplied with nitrous gas in the ordinary way. It is proposed further to economize the heat of the furnaces and gases, by causing the latter to enter another chamber *k*, (fig. 2,) in which are placed pots *l, l*, filled with nitre, which, being acted upon by the heated gases, will give off nitrous gas in great quantities. A portion of this nitrous gas will combine with the sulphurous acid gas, and be converted into sulphuric acid gas in the chamber *k*, from whence, with the uncombined gases, it will be conveyed through the flue *m*, to the condensing chamber.

Fig. 3, is a longitudinal section, and fig. 4, a transverse section of another arrangement of apparatus for facilitating the combination of the oxygen of the air with sulphuric acid gas. This apparatus may be used either alone or in combination with that above described.

The object of this arrangement is to utilize the waste heat given off from coke ovens, and which is usually allowed to escape uselessly along the flue to the chimney, and from thence into the atmosphere. The sulphurous acid gas from the ordinary furnace, or from the improved furnace above described, is conveyed in combination with atmospheric air along a flue or chamber, which is heated by the waste heat of the coke ovens. *a, a*, (fig. 3,) is the furnace for burning the sulphury pyrites; the gases from which pass along a flue or narrow chamber *i, i*, filled with pebbles, stones, or other material not liable to be acted upon by heat or the acid. Above and below this flue or chamber *i, i*, are other flues or chambers *n, n*, which communicate with the coke ovens, as shewn at *o, o, o*. As the heated gases from the ovens pass along the flues *n, n*, they heat the sulphurous acid gas and atmospheric air in the central flue *i, i*, and thereby facilitate the combination of the gases and conversion of the sulphurous acid into sulphuric acid.

It will be understood from the foregoing description that the sulphurous gases from the furnace are heated in their own flue by the heat passing along the flues from the coke ovens. Sometimes, however, a separate flue is dispensed with, and the sulphurous gases are carried direct from the furnace into the flue from the coke ovens; and as all the combustible gases will be consumed in the flue, the sulphurous and sulphuric acid gases will be conducted from the flue to a condenser in which the sulphurous acid will have

an additional dose of oxygen given to it, so as to convert it into sulphuric acid; and this latter will be condensed by means of water, or in the way hereafter described.

Strong sulphuric acid may likewise be used in combination with nitrous gas or nitric acid, as an absorbent of sulphurous acid, which, in combination with atmospheric air and nitrous gas, is brought from the furnace into the condensing chamber, in which it meets with the nitro-sulphuric acid, and whereby the combination is facilitated. For this purpose sulphuric acid, of a strength of about one hundred and thirty-four degrees on Twaddle's hydrometer, is used. In carrying out this process sulphurous acid gas and atmospheric air are caused to percolate through a tower or column supplied with coke, moistened with strong nitro-sulphuric acid, which is made to percolate through the mass of coke in the opposite direction. The sulphurous acid gas becomes absorbed by the nitro-sulphuric acid, and absorbs oxygen from the nitrous gas and atmospheric air which accompanies it, and is by this means converted into sulphuric acid. The nitro-sulphuric acid, in its passage through the coke, will meet with and absorb the ascending sulphurous acid, which will receive a dose of oxygen, and be converted into sulphuric acid. This will run out at bottom, and will be found charged with nitrous gas, and may be used again for absorbing an additional quantity of sulphurous acid.

The arrangement of apparatus for carrying out the above object will be best understood by referring to fig. 5, which is a side elevation of the apparatus,—the furnace for generating the nitrous gas being shewn in section. Fig. 6, is a longitudinal vertical section through the whole apparatus. The masonry of the nitrous gas furnace is shewn at *a, a, a*; the fire-place at *b, b*. In this fire-place is burned coke or other suitable combustible; and the heat evolved therefrom passes along the flues *i, i, i*, which surround a chamber *k*, containing any suitable number of pots *l, l*, supplied with nitre, which will be decomposed by the heat, and nitrous gas driven off along the flue *m*, into the tower or column *p*, at *m*, fig. 6. The sulphurous gas, obtained from any convenient source, and mixed with atmospheric air, is supplied by the pipe *q*, to the small tower or chamber *r*, which, as well as the column or tower *p*, is filled with coke, pebbles, stones, or other substance not liable to be acted upon by the acid. The uncombined sulphurous acid passes through the chamber *r*, into the lower end of the column or tower *p*, as shewn in fig. 6; and while ascending, is brought in contact with the nitrous gas

supplied at *m*, and also meets with a continual stream of nitro-sulphuric acid, which is supplied from the upper part, and made to trickle down the mass of coke or other material contained in the tower. The uncondensed gases are, by means of a pipe *s*, conducted from the upper part of the tower *p*, to a similar tower *p*\*, where they are again brought in contact with nitro-sulphuric acid; so that all the sulphurous acid gas will be converted into sulphuric acid, which will run out at bottom into any convenient receptacle. The atmospheric air and other uncondensable gases are carried off through the pipe *t*, to the chimney; whereby a sufficient draught is created to cause the gases to pass with facility through the apparatus, and be properly operated upon. Such an excess of nitrous gas is supplied to the towers through the pipe *m*, that the sulphuric acid that runs out of the towers *p*, and *p*\*, will be found charged with this gas. The required quantity of acid may therefore be pumped up again to the top of the towers, to act upon a further supply of sulphurous acid; and all the superabundant acid from the towers is conducted to the upper part of the chamber *r*, and allowed to percolate through the same, and come in contact with the ascending current of sulphurous acid; a part of which will be converted into sulphuric acid, and will fall to the bottom; from whence it may be drawn off in any convenient manner.

As the liquid acid, in percolating through the towers, will be continually increasing in strength, it will be necessary to cautiously supply, from time to time, small quantities of water or steam; but care must be taken that the strength of the acid supplied to the towers is never below 134° of Twaddle's hydrometer.

It will be seen that, according to this improved plan of making sulphuric acid, the ordinary vitriol chambers are not made use of; but the principle of the improvements may be advantageously applied to the ordinary manufacture of sulphuric acid, as an excess of uncondensed sulphurous acid may then be passed through the vitriol chambers into an apparatus similar to that above described, where all the sulphurous acid will be quickly converted into sulphuric acid.

By adapting the above-described improvements to the vitriol chamber of an ordinary apparatus for manufacturing sulphuric acid, an excess of sulphurous acid may be passed through the chamber; and thus the nitrous acid will be prevented from acting upon the lead, of which the chamber is constructed: by this means the chamber will be preserved, and will last much longer than usual.

The second part of this invention relates, as before mentioned, to a means of separating arsenic from sulphuric acid. To effect this object the impure acid is caused to percolate through a vessel containing a bed of pebbles, through which a stream of sulphuretted hydrogen is made to pass: the sulphuretted hydrogen will be thereby decomposed, and the sulphur will combine with the arsenic in the acid, and form what is called yellow orpiment, which afterwards may be separated from the sulphuric acid by filtration, and the sulphuric acid will then be in a proper state for evaporation.

Fig. 7, is a side elevation of the apparatus for effecting this object. The sulphuretted hydrogen is generated, according to any of the well-known methods, in the vessel *v*, from whence it rises into the chamber *w*, and thence into a similar vessel *w\**, both of which are filled with stones or pebbles, and are supplied from above with the impure acid. The acid, in descending through the vessels *w*, *w\**, comes in contact with the ascending current of sulphuretted hydrogen, which, by combining with the arsenic contained in the acid, becomes decomposed, and produces yellow orpiment, which, by the descent of the liquid acid, will be washed out of the vessels *w*, and *w\**, into the trays *y*. The uncombined gases will pass off through the pipe *x*, into the chimney; and the purified acid from the trough *y*, of the vessel *w*, will fall into the filter *z*, made of sand or other suitable substance, from whence it may be drawn out by the cock and concentrated in the ordinary manner.

The patentee claims, First,—heating the gases in their passage from the furnace to the condenser, by means of the spare or waste heat of the furnace, or the spare or waste heat of coke ovens or other furnaces; so that the gases may be made to combine with avidity, and produce sulphuric acid. Second,—the use and application of nitro-sulphuric acid, or any other similar or analogous compound, for absorbing sulphurous acid, and acting upon it in the manner above set forth. Third,—separating arsenic from sulphuric acid, by means of sulphuretted hydrogen, as above described.

---

To JOHN WEBSTER COCHRAN, of Gower-street, for improvements in machinery for crushing, grinding, and pulverizing stone, quartz, or other substances.—[Sealed 20th August, 1853.]

THIS invention consists in certain means of maintaining the efficiency of machinery for crushing, grinding, and pulverizing stone, quartz, and various other substances.

In Plate II., the machinery forming the subject of the present invention, is shewn in sectional elevation and in plan view at figs. 1 and 2. A circular plate or disc  $a^*$ , flanged or curved upwards throughout its whole circumference, is firmly fixed on a strong foundation  $p$ . In the concave part of this plate  $a^*$ , are loosely placed several balls, hollow spheres, or shells  $b^*$ , generally six in number,—each alternate ball being of a smaller size. On the balls, hollow spheres, or shells  $b^*$ , is placed a table-plate or disc  $c^*$ , similarly formed to the plate  $a^*$ , just described, but otherwise differing from it in its inverted position and mobility. The upper plate or disc  $c^*$ , being put in motion, its pressure on the balls  $b^*$ , the amount of which is regulated by the weight given to or placed on this plate, forces them to circulate between the two plates or discs  $a^*$ ,  $c^*$ , in a complex rotary manner,—the effects of which are both to roll and grind any substance brought in contact with them. In place of balls, spheres, or shells, conical or other wheels might be used in connexion with, and driven by, an upper plate, similar to that above mentioned.

The different improvements which the patentee proposes to make in a machine, such as that just described, are as follow:—Firstly, renewing, with facility, those parts of the machine more immediately liable to wear and damage. The particular portions of such machinery thus exposed are where the upper and lower plates or discs  $a^*$ ,  $c^*$ , are in conical contact with the balls and stone, quartz, or other substances being operated upon. To remedy this defect, without replacing entirely the plates or discs, the upper and lower plates are inlaid with moveable discs or bushings  $a$ ,  $a^1$ , which are held in their places by bolts  $b^*$ , as shewn in the drawing, or in any other simple manner. These discs or bushings, when worn to any extent, may be replaced by others; and thus the efficiency of the machine will be renewed with little cost or trouble. The moveable discs or bushes  $a$ ,  $a^1$ , may be composed of any metal, or the grooves, in the upper and lower plates in which they are placed, might be filled with cement or other material; and thus, with suitable balls, all kinds of ores, grain, dyes, drugs, seeds for making oil, &c., might be crushed, ground, or pulverized. Any one or all of the plates or discs may be constructed hollow, so as to receive hot air or steam, when, during the process of grinding, certain substances, such as seeds for making oils, &c., require to be kept hot.

Secondly, the flange  $c$ , forming the outer circumference of the lower plate  $a^*$ , is made to receive standards  $d$ , for support-

ing a grating or bolting-screen *e*; through which, when the machine is at work, the crushed, ground, or pulverized matter, whether wet or dry, is forced, by the rapid centrifugal motion imparted to it by the action of the balls and upper plate. After passing through the grating *e*, the ground matter is received into a trough *f*, formed round the outside of the lower plate *a*\*, and thence may be passed off through tubes *g*, to the amalgamators or elsewhere. The number of these standards *d*, and sheets or panels 1, 2, 3, &c., of the grating *e*, may be regulated at pleasure. The lower edges of the panels rest in a groove *h*, cast in the outer edge of the lower and stationary disc or plate *a*; and the sides of the panels are bent into wedge-like recesses, formed in the inside of the standards *d*. These recesses are made sufficiently large to receive keys *j*, which are tightened by bolts passing through the standards, and tapped into the keys, or in any other convenient way. These keys *j*, not only tighten and secure the panels, but, their thickness being so regulated as to make them flush or even with the inside of the panels, the result is, that the whole interior of the grating and keys presents a perfect uniformity of circular surface; so that, when the ground matter is ejected from the lower plate, and comes in forceful contact with this surface, the minimum of resistance is opposed to the egress of such matter through the pores of the grating. The panels being fitted in their places, independently of each other, any one or more of them may be replaced, with the greatest facility, when worn, or when the substances to be ground require to be of a different fineness. A sheet-iron or other covering *k*, extends from the outside extremity of the trough *f*, to within a short distance of the upper plate *c*, where it may be finished off with a border, composed of some elastic substance, such as leather.

Thirdly, the centre of the lower plate or disc *a*\*, rises in a conical form, as best suited to facilitate the crushing of the stone, quartz, or other substances, as they enter the machine and come first in contact with the balls. The centre shaft *l*, rising up the interior of this cone, which is formed into a bearing for it, enters a hub *m*, attached to the upper or rotary plate *c*\*, by means of arms *n*, of wrought-iron. It is considered most convenient to fix the upper end of the shaft *l*, to this hub *m*, by an intermediate bushing *o*,—the extreme outline of which, whether octagonal, as shewn in the drawing, or otherwise, must correspond with and fit into the aperture, of whatever shape it may be formed, in the hub *m*, to receive it. A slightly convexed square hole is left in the middle of

the bushing *o*; and the end of the centre shaft *l*, which is also square, is made to fit exactly within the extreme points of this convexed aperture. The object for making the bushing in this form is to avoid any undue friction or jarring of the parts of the machine. It will be obvious that, when the machine is at work, considering that the balls must rise and fall as they pass over the different sized pieces of matter submitted to their action, the upper plate *c\**, and balance-wheel *d\**, which rest upon the balls, will be continually rising or rocking during their rotary course. The upper plate or disc *c*, being in connection with the bushing *o*, by means of the hub *m*, when the end of the centre shaft *l*, is properly placed within this bushing, and the machine is in action, the convexity given to the hole in the bushing, allows the upper plate or disc *c*, sufficient scope to rock, and therefore gives free and unconstrained action to the whole machinery. The same object may be effected by making the end of the shaft convex, with simply a square hole in the bushing, or by giving other forms to the bushing and shaft.

Fourthly, motion may be given to the upper plate *c\**, either by means of a belt passing round that part of the upper plate *c\**, made in the form of a pulley, or by a pulley on the centre shaft *l*. The patentee prefers, however, to give rotary motion to the upper disc or plate *c\**, by attaching the centre shaft *l*, which is connected with this plate, as above described, directly to the cross-head of a steam-engine *q*, placed immediately below the machine. This arrangement is clearly shewn in the drawing.

The action and operation of the machine are as follow:— The lower end of the centre shaft *l*, being attached to the cross-head of a steam-engine *q*, placed directly beneath the machine, the shaft *l*, and, consequently, the upper plate *c\**, and balance-wheel *d\**, which are connected with it, are made to turn. Rotary velocity, properly regulated to suit whatever substances are intended to be crushed, ground, and pulverized, is thus given to the upper plate and balance-wheel. The substances to be operated upon are then put through an aperture made in the centre of the upper plate for that purpose; and thence, as indicated by the arrows, pass under the balls, by which they are gradually crushed, ground, and pulverized. Reduced to this state, the substances are forced, by the rapid centrifugal action of the balls, over the outer edge of the lower plate or disc *a\**, and against the grating or bolting screen *e*; through the pores of which they pass and fall into the trough *f*, which surrounds the lower plate *a\**, and are

finally carried off, as still shewn by arrows, through tubes *g*, towards the amalgamators, or whatever other receptacles may be intended for them.

The patentee claims, Firstly,—the manner of constructing the outside plates or discs, so as to receive interior moveable discs or bushings, combined and arranged for purposes such as are hereinbefore described. Secondly,—the construction and arrangement of the standards, grating, or bolting screen and trough, in manner substantially as above specified. Thirdly,—the manner of constructing the centre hub and bushing, connected with the upper and moveable plate, which is turned by them through the medium of the centre shaft, attached to a steam-engine, without any intermediate gearing, substantially as set forth.

---

To JAMES WORRALL, jun., of Salford, in the county of Lancaster, dyer and finisher, for certain improvements in the method of dyeing fustians and other textile fabrics, and in the machinery or apparatus connected therewith.—[Sealed 11th October, 1853.]

THESE improvements consist in the method of dyeing fustians and other textile fabrics, and in the machinery or apparatus connected therewith,—the object and purposes of such improvements being to economize labor, prevent loss and waste of the dyeing material, and to saturate and fix the dye into the cloth more effectually than has hitherto been done by any of the ordinary methods or processes. These improvements are effected, first, by passing two or more pieces, simultaneously, through the apparatus; secondly, by carrying the pieces upwards over a geared or drawing-through roller, placed above the cistern, and in a perpendicular line with the partitions forming the “becks;” thirdly, by employing a pipe, heated by steam or other suitable means, to separate the pieces previous to their passing over the geared or drawing-through rollers, and, at the same time, admit air to the inner sides of each piece, and also to heat the same; fourthly, by employing a perforated pipe, to separate the pieces before or after (as may be desired) they have passed over the geared or drawing-through rollers, through the holes in which the dyeing liquor or mordant is forcibly injected on to and into the cloth, so as the more effectually to saturate the same; and, fifthly, by the introduction of a cylinder into one or more of the becks; into which steam or any other suitable heating medium is



admitted, for the purpose of heating the cloth, and, at the same time, also the dyeing liquor which surrounds it.

The figure in Plate II., is a sectional elevation of the general arrangement of machinery or apparatus, shewing the direction or course given to the cloth, during the process of dyeing, successively under and over the various rollers. *a, a*, are the rollers, upon which the cloth has been previously wound; and *b*, a roller, over which the several pieces of cloth are first passed. They are then passed under the guide-roller *c*, and then upwards,—passing on opposite sides of the steam-pipe *d*, and running in contact over the geared or drawing-through roller *e*. It afterwards passes downwards on either side of the perforated pipe *f*, and, in like manner of succession, under a guide-roller and over a geared or drawing-through roller, until the cloth arrives at and is passed under the steam-cylinder *g*, which also serves as a guide-roller. The pieces are next brought in contact, and pass over and under the succeeding rollers, in the manner previously described. *h*, is a pipe for supplying the pipes *d, d*, with steam; *i*, the hanging-frame, having bearings at *j, j*, in which the geared or drawing-through rollers revolve during the traverse of the cloth while undergoing the process of dyeing. *k, k*, are the becks or divisions, separating and containing the saddening or dyeing liquor; and *l, l*, is another cistern, placed end to end of the previously-described one, containing a solution of copperas or other suitable mordant liquor, in order to fix the dye in the cloth immediately upon its passing out of the first-described or dyeing cistern. *d, d, d*, are the steam-pipes, supplied by the main pipe *h*. *e, e, e*, are the geared or drawing-through rollers,—the hanging-frame, in which they revolve, not being represented in the drawing, in order to shew, more clearly, the arrangement of the pipes *d, d*. *f, f*, are the pipes through which the dyeing liquor is injected on and into the cloth, and which is pumped out of the becks *k, k*, also the mordant becks *l, l*, by means of force-pumps, that may be attached to the side of the cistern, and worked by a crank, fixed upon any of the axes of the geared or drawing-through rollers. The stroke of the pumps should be capable of being increased or diminished, by lengthening or shortening the throw of the crank, and thus cause any of the pumps to lift any quantity of the dyeing liquor that may be required, according to the nature of the cloth under operation. The steam-pipes will be most conveniently fixed upon that side of the geared or drawing-through rollers upon which the cloth ascends from the becks; and the perforated pipes upon that

side of the roller upon which the cloth descends to the next beck; but, in some cases, the perforated pipes will be required on each side of the roller. The whole of the axles of the geared or drawing-through rollers, which must revolve at an uniform rate of speed, are driven by suitable shafting and gearing. At the side of the cistern, and communicating with the beck containing the steam-cylinder, is fixed an apparatus for measuring and registering the quantity of dyeing liquor as it flows into the beck; having connected therewith a float or ball-tap to shut off the supply of liquor when the beck is full. Each of the geared or drawing-through rollers, over the first-described cistern (excepting the last one), is supplied with a steam-pipe, and also a perforated pipe parallel with it, one on each side. Through all the perforated pipes over the becks *k, k*, (except the first) dyeing liquor is injected into the cloth by the means hereinbefore described; and into the first only, lime-water, or other suitable liquor, is injected, and, by that means, on to and into the cloth, and also through the perforated pipes over the mordant liquor-becks *l, l*. The mordant liquor is injected into and up to the cloth by means hereinbefore described. When more than two pieces are passed through the apparatus at one time, a steam-pipe, as also a perforated pipe, must be placed between every two pieces,—each pipe having one piece of cloth in contact with either side of its circumference, and thereby separating the pieces from contact with each other.

The patentee claims, Firstly,—the passing of two or more pieces of fustian and other textile fabrics simultaneously through the dyeing liquor, and then over geared or drawing-through or other rollers. Secondly,—the employing a heated steam-pipe to separate the pieces previously to their passing over the said rollers. Thirdly,—the employing a perforated pipe to separate the pieces either previous to or after they have passed over the said rollers. And, Fourthly,—the introduction of a steam-cylinder in one or more of the becks, to heat the dyeing liquor and the cloth, as required.

---

*To HENRY KRAUT, of Zurich, in Switzerland, for improvements in tools or implements to be used for boring or cutting rock or other hard substances, for the purpose of blasting.*  
[Sealed 15th September, 1853.]

THIS invention consists in an improved tool or borer for cutting out a chamber at the bottom of the hole made by the

common jumper generally used for blasting; which chamber is intended to receive the powder or other explosive agent.

In Plate I., fig. 1, represents an improved borer for cutting out chambers in holes of larger diameter, with part of the rock in section, shewing a portion of the hole made by the common jumper, as well as part of the chamber; and fig. 2, is a ground plan of the same. Fig. 3, is an improved borer for holes of smaller diameter, with part of the rock in section, shewing a portion of the hole and chamber; and fig. 4, is a cross section of the same.

In figs. 1 and 2, *a*, is a bar of iron, at the lower end of which a steel blade *b*, is inserted into a groove *c*, and secured by pins or set screws *d*. The lines *e*, indicate an enlargement of the bar to increase its strength, and to protect the set screws *d*. From the side opposite the cutting-edge \*\* of the blade *b*, the bar *a*, and blade *b*, are tapered off, so as to form an inclined plane *a\**, *b\**, of any desired angle. *f*, represents the hole made by the common jumper reaching down to the dotted line *g*. After the common jumper is withdrawn from the hole *f*, the improved borer *a*, is introduced into it, and brought to act upon the rock in the same manner as the ordinary jumper, either by means of hammers or by the process usually called "churning,"—one man guiding and turning it round. It is evident that every time the borer is made to descend, the incline plane will force the edge \*\* of the blade *b*, laterally into the rock; whilst the bottom part of the blade will, to some extent, cut the rock in a vertical direction; and thus a chamber *h*, will be formed progressively in a manner similar to that indicated by the dotted lines 1, 2, 3, &c. From the time the chamber has been widened by twice the distance the blade *b*, projects beyond the bar *a*, or thereabouts, the continued action of the borer will increase its depth only. The conical elevations 1<sup>1</sup>, 2<sup>1</sup>, 3<sup>1</sup>, &c., which are formed during the process of boring, will, in some instances, have to be removed with the ordinary jumper; the loose stone and sand being scooped out, from time to time, by means of the scraper, in the usual way.

In the borer shewn at fig. 3, the part *b*, *b*, is of solid steel, and welded on to the iron rod *a*; it is represented as arrived at the bottom of the chamber *h*. The length of the cutting-edge \*\*, in figs. 1, and 3, varies according to the hardness of the substance to be cut. For hard stone, the cutting-edge has to be made as short as or shorter than that shewn in fig. 3; and, for soft stone, it may be made as long as or longer than in fig. 1. In determining this length, however, the operator must be guided by experience.

The blade *b*, of the borer shewn at fig. 1, may, if preferred, be welded into the bar *a*: or the cutting end may be made entirely of steel, as described with reference to fig. 3.

The superiority of this method of blasting, over that in ordinary use, is twofold. In the first place, it effects a great saving in time. It is well known that three men will bore a hole of  $1\frac{3}{4}$ -in. diameter to a given depth, in one-third of the time required for a 3-in. hole. And as a chamber of 3-in. diameter at the bottom of a bore of  $1\frac{3}{4}$ -in. diameter, answers the same purpose as a uniform hole of 3 in. diameter made by the common jumper, it is evident that, making a liberal allowance for the time required to form a chamber, the economy of labor must amount to at least 40 or 50 per cent. And, in the second place, it is clear that a given quantity of powder deposited in a chamber formed as described, must produce a far better effect than if it were placed in a hole of uniform diameter.

The patentee does not confine himself to the particular shapes of the borers shewn and described; but he claims, Firstly,—the projecting part or blade *b*, of the borer; and, Secondly,—the inclined plane *a\**, *b\**, at the lower end of the borer, for the purposes hereinbefore described.

### Scientific Notices.

#### ROYAL DECREE, WHICH REGULATES THE EXECUTION OF THE NEW BELGIC PATENT LAW.

IN our last Number we were unable, from the lateness in the month at which the New Belgic Patent Law received the royal assent, to give more than a translation of the Act itself as it passed the Legislature; we now, however, publish the Decree, which prescribes the mode of action hereafter to be pursued in obtaining Belgic patents.

**LEOPOLD, KING OF THE BELGIANS:**—*To all to whom these presents shall come, greeting. Considering the law of 24th May, 1854, relative to patents of invention, importation, and improvement; desiring to determine the general regulations for the execution of that law; upon the proposition of our Minister of the Interior, we have ordered and do order:—*

**ART. 1.** Any person desirous of obtaining a patent of invention, importation, or improvement, shall deposit a petition to that

effect, at the registry office of one of the provincial prefectures of the kingdom, or at the office of one of the district commissariats of arrondissement of the province.

To this petition shall be annexed, under a sealed envelope,—

- 1st. A description of the object invented.
- 2nd. Drawings, models, or specimens, which will render the description intelligible.
- 3rd. A duplicate certified copy of the description and drawings.
- 4th. An inventory of the documents and articles deposited.

ART. 2. The deposit of the documents, &c., mentioned in Art. 1, shall only be received upon the production of a receipt, verifying the payment of the sum of 10 francs—forming the first annuity of the duty. This receipt shall be annexed to the other documents.

ART. 3. The petition shall be prepared upon stamped paper: it shall set forth the christian and surname, profession, and real or chosen domicile of the inventor, in the kingdom; and it shall set forth a title, giving the precise and summary designation of the object of the invention. Each application shall only include one single principal object, with the details incident thereto, and the applications which shall have been set forth.

In the case of a patent of importation, the petition shall make known the date and term of the original patent, and the country in which it has been granted. If the petitioner is not the patentee of the foreign patent—but is empowered by him—he must prove his title, by means of a deed, in due form.

ART. 4. The description must be prepared either in the French, Flemish, or German language. If the description be not prepared in French, it must be accompanied by a translation in that language, when the inventor does not reside in Belgium. The description must be written without alteration or addition; the words struck out must be counted and verified; and the pages and references marked. The description shall set forth the invention in a clear and complete manner, and shall conclude by a precise statement of its characteristic features.

ART. 5. The drawings must be in ink, and drawn to a metrical scale: they shall represent the machine or apparatus to be patented, as nearly as possible, in plan, section, and elevation. Those parts of the drawings which specially characterize the invention, shall have a different color from that of the other parts.

ART. 6. All the documents must be dated and signed by the petitioner, or the person empowered by him,—whose power, duly legalized, shall remain annexed to the petition.

ART. 7. A certificate, prepared by the registrar of the provincial prefecture, or by the commissary of arrondissement, shall verify the date of the deposit of each packet. The invention shall be therein designated under the title which the petitioner shall have set forth. This certificate shall contain the christian and

surname, designation and residence, of the petitioner, or the person empowered by him. It shall also set forth, in the case of a patent of importation, the date and term of the patent of invention in the country in which it originated, and the name of the patentee. Lastly, mention shall be therein made of the payment of the first annuity. This certificate shall be signed by the person depositing, and by the person who prepares it, and shall be fixed on the envelope of the packet containing the documents relative to the application for the patent. A copy of the certificate shall be delivered, free of expense, to the person depositing.

ART. 8. The legal date of the invention is verified by the said certificate.

ART. 9. The offices of the provincial registrars, and of the commissaries of arrondissement, shall be open for applications for patents, every day (Sundays and holidays excepted), from 10 A.M. until 2 P.M.

ART. 10. All documents relating to applications for patents shall be transmitted, within five days, to the Department of the Interior.

ART. 11. On the arrival of the documents at the Department of the Interior, the applications shall be registered, in the order of date of their deposit, upon a special register, which may be consulted by the public every day (Sundays and holidays excepted), from 10 A.M. until 2 P.M.

ART. 12. In case of omission, or irregularity in the form, the applicants shall be required to make the necessary corrections. A memorandum shall be made of the date of these corrections upon the special register mentioned in the preceding article.

ART. 13. Those patents which have been applied for in a regular manner shall be granted without delay.

A decree of our Minister of the Interior, verifying the fulfilment of the prescribed formalities, shall be delivered to the applicant, and shall constitute his patent.

ART. 14. The patent shall expressly mention that the grant thereof is made without previous examination, at the risk and peril of the petitioner, without guarantee either of the reality, novelty, or merit of the invention, or the correctness of the description, and without prejudice to the rights of other persons.

ART. 15. The first copy of the patent shall be delivered free of expense. All subsequent copies applied for by the patentee, his assignees, or parties empowered by him, shall be paid for.

ART. 16. The specifications of patents shall be published in full, or in substance, by the government, in a special publication, three months after the grant of the patent.

When the patentee desires to procure the complete publication of his specification, or of an extract furnished by him, he must give notice thereof to the government, at least one month before

the expiration of the term fixed in the preceding paragraph, and pay the sum necessary to cover the expenses of this publication.

ART. 17. After the expiration of this term of three months, the public shall be allowed to inspect the specification; and copies thereof may be procured on payment of the expenses.

ART. 18. If a patentee should be desirous of obtaining an extension (in the case provided for by Art. 23 of the law) of the term for working the patented invention, he must make his application to the Minister of the Interior, two months, at least, before the expiration of the term fixed by the said article. This application must shew reasonable grounds therefor, and must set forth, within the legal limit, the term necessary for working the invention.

ART. 19. Any assignment or change of proprietorship (either total or partial) of the patent, must be notified to the Department of the Interior. The notification of assignment, or of any other act, involving change of proprietorship, must be accompanied by an authentic copy of the deed of assignment or other deed.

ART. 20. Patentees whose patents have neither expired nor become void at the period of the publication of the law of 24th May, 1854, may have their patents made subject to the provisions of this law, on application before the 25th May, 1855.

Patentees who, at the time of applying for the privilege of this provision, shall not have paid a sum equal to the amount of annual payments due on the years expired, according to the provision of Art. 3 of the law, shall be bound to effect or complete this payment, and to prove it by a receipt which they shall annex to their petition. In default of this formality being complied with, the application will not be entertained. A declaration, verifying that the patent is placed under the *régime* of the new law, shall be sent to the applicant.

ART. 21. All grants of patents, deeds of assignment or change of proprietorship, and also the declarations mentioned in the preceding article, shall be published in the "Repertory of Patents." This shall also be the case with the decrees pronouncing the nullity of the patent.

ART. 22. The original specifications and drawings of expired patents shall be deposited in the *Musée de l'Industrie*.

ART. 23. Our Minister of the Interior is charged with the execution of the present decree.

Given at LAEKEN, 24th May, 1854.

*By the King.*

LEOPOLD.

*The Minister of the Interior.*

F. PIERCOT.

## INSTITUTION OF CIVIL ENGINEERS.

May 23rd, 1854.

THE paper "*On the casualties of tunnelling, with examples,*" by Mr. W. M. PENISTON, M. Inst. C.E., was in reality a relation of the difficulties encountered in the formation of some tunnel headings through chalk and green sand, under a head of water, at Holywell, on the line of the Wilts and Somerset Railway.

The materials had been collected from the author's diary of the proceedings, and it had been his intention to give many more details, as practical examples for the younger members of the profession; but with access to the excellent work on tunnelling, by Mr. Simms, it was feared that the communication might be deemed too prolix.

It was intended that No. 1 tunnel should have been constructed in the usual manner, by sinking shafts, and connecting them by a bottom heading, running through between open cuttings at the north and south ends. There were, however, indications, from the borings, of the ground being unfavorable, the body of the tunnel being in chalk full of faults, whilst the cuttings at both ends were in green sand; and copious springs shewed themselves along the line of operations, which were conducted through strata generally dislocated, and not to be depended on. In sinking the shafts, the water brought away with it such quantities of sand as to create cavities around, and produce serious failures in the timbering, which required to be renewed and replaced several times. Numerous contrivances were essayed for overcoming the difficulties, — gullets were cut at lower levels, in hopes of their drawing off the water; but the tenacity of the soil, and the numerous faults, precluded any chance of their being useful. Nothing but incessant pumping could therefore be relied upon; but the consequence of this was, that the framing of the shaft sunk bodily, until it was retained by a hanging kerb and rods from the surface. Then, in spite of close sheathing planks, a lateral settlement occurred, and amidst a recurrence of these accidents the shaft was carried down until the sand and water rose so rapidly in the bottom, that it was necessary to close it by a timber platform, through which the water rose to a certain level, whence it was pumped. Similar difficulties were encountered in the other shafts, enhanced, in one case, by the frequent recurrence of boulders of sand-stone, which occasioned much loss of time and inconvenience in extracting them, and left large cavities behind the sheathing. The quantity of water also increased so much, that the briefest delay in pumping obliged the men to leave the headings.

At length, it being observed, that the dip of the sand-rock, which was the water-bearing stratum, was in such a direction as to induce the inference that it might be used to convey the water away, by having it tapped at a lower level: the attempt was made,



and was attended with success. In the subsequent extension of the open cuttings the numerous vertical faults were shewn to have been, in a great degree, the cause of the slips in the shafts.

In consequence of observations on the saturated strata, it was determined to try the effect of a syphon, which was accordingly laid down. It was formed of cast-iron pipes, 6 in. diameter; the short leg dipping into a hole at the bottom of one of the shafts, whilst the long leg extended through the crown heading, and terminated in a cistern in the north cutting. By means of a hand-pump, at the upper bend, the air was exhausted; and the action was so perfect as to drain the blocks of sand, and enable the headings to be completed.

Accounts were given of the numerous ingenious contrivances resorted to for overcoming difficulties, and also of the effects of the drainage upon the springs and wells in the neighbourhood. The various machines and devices employed, were described, in connection with all the tunnels: in fact, the paper was, as it professed to be, a detail of the casualties of tunnelling, under circumstances of considerable difficulty; and it was well illustrated by a series of diagrams, shewing the works in all stages of their progress.

---

May 30th.

The President's annual conversazione was held on this evening, and concluded the meetings of the session.

---

### INSTITUTION OF MECHANICAL ENGINEERS, BIRMINGHAM.

At a Special General Meeting of the Members, held in the Lecture Theatre of the Royal Institution, Mosley-street, Manchester, on Wednesday, Dec. 7th, 1853,—WILLIAM FAIRBAIRN, Esq., Vice-President, in the Chair,—the following paper, by the Chairman, was read:—

*On a new description of winding-engine.*

The subject of the following communication is a steam-engine recently erected by W. Fairbairn & Sons, for F. D. P. Asley, Esq., of Dunkinfield, for the purpose of winding coal from a pit of nearly 700 yards in depth.

This pit from its great depth presents several peculiar features with respect to surrounding mines. Being at the lowest level, it drains several of the adjacent pits, and thus has the onerous duty thrown upon it of draining the whole of the superincumbent works, or those at a higher level. On account of this circumstance, a large pumping-engine was required for clearing those mines of water.

The winding-engine is constructed on the "direct-action"

principle—the same in fact as those which some years since were constructed for Her Majesty's frigates, "Vulture," "Odin," and "Dragon," by William Fairbairn & Co., at Mill-wall.

The pit from which the coal has to be extracted is 12 feet in diameter, and is walled with Ashlar stone to a depth of about 40 yards from the top; and from thence to a depth of 201 yards is a wedging curb of oak. From this point it is made water-tight through layers of sand and porous rock, by metal tubing, to a depth of 248 yards from the surface, and the remainder is walled with either stone or brick,—excepting only in those parts where the sides are of solid rock, capable of standing without interior support.

The shaft is divided into three compartments,—one being used for the pumps, and occupying about one-fifth of the area of the shaft. Of these pumps there are five sets—four of them plunger-pumps of 15 in. diameter, and varying in length from 400 to 420 feet each; and the fifth and lower set a 12-in. lifting-pump.

The other compartments or divisions form a large space for the slide-bars and cradles, each of which admit of four coal-boxes, one above another; and in this position they are raised at once from the bottom of the shaft to the surface. Each box has four wheels adapted to the tram-ways below and above; and as soon as they arrive at the top, or descend to the bottom, the loaded boxes are exchanged for empty ones above, and the process is reversed at the same instant below. The cylinder of the engine is 60 inches diameter, has an 8-foot stroke, and stands upon a cast-iron pedestal, firmly bolted to a platform of masonry, resting upon four cast-iron beams, which stretch across the house, with their ends inserted under the walls on both sides. These walls vary from 4 to 3 feet in thickness as they ascend, and rise to a height of 50 feet above the foundations; and thus, it will be observed, from the weight resting upon the iron beams, a degree of solidity is given to the foundations which could not otherwise be obtained, unless at greatly increased expense in the erection of an ashlar platform.

From the foundations to the entablature which supports the crank-shaft and two fly-wheels, and on the periphery of which the wire ropes wind, rise four massive cast-iron columns, equidistant on each side of the cylinder; and these being secured by bolts to the foundations below, and the entablature above, a complete connection is thus effected; which, acting in combination with the weight of the engine-house wall, gives a degree of solidity more than sufficient to resist the reciprocating action of the engine at a pressure much greater than 30 lbs. on the square inch.

In this description of engine, where the action is direct from the piston-rod to the crank, it usually occurs that the preponderating weight of the connecting-rod, crank, and piston, causes great irregularity of motion: to remedy this defect, balance-

weights have frequently to be attached to the fly-wheel, or some other part of the engine, to cause uniformity of motion. In the present engine these adjuncts are not required, as it has been contrived to balance the difference of weight in the up-and-down strokes by the lift of the air-pump. This answers the double purpose of exhausting the condenser, and of forming radius bars for the direct vertical motion of the piston. In this operation a perfectly direct motion is not only effected, but the parts are so nearly balanced as to enable the engine-man to raise and lower any weight, however heavy or light, with an extraordinary exactitude; and, in fact, such was the accuracy of the motion, that the "sinkers" availed themselves of the engine, for the purpose of lowering, raising, and setting the stones used in walling the sides of the pit.

The working of the engine is accomplished by excentrics from a shaft which extends from the crank to the opposite wall. These excentrics give motion to the plug-rod, which works the valves, and, acting upon the lever or handle, enable the engineer to regulate the speed and reverse the motion at pleasure. All these valves are double-beat, upon the equilibrium principle; and the result is, that they are worked, at any amount of pressure, without any increase of balance in the handling or the working of the engine.

For the purpose of winding or raising the coal, flat wire ropes are employed at this pit. They each weigh about 2 or 3 tons, with the addition of the cradle and boxes. These boxes each contain 8 cwt. of coal, collectively 32 cwt., which is the load to be raised from the bottom of the pit to the surface in one minute. This gives a velocity of nearly 2000 feet per minute, or about 23 miles an hour. The power exerted by the engine is nearly 220 horses, independent of friction, and the immense preponderance of rope which has to be overcome at starting from the bottom of the pit. This is, to some extent, equalized by the balance-chain, which unrolls itself from the drum in its ascent within the well behind, till the cradles meet; when the motion of the balance-chain is reversed, and the chain begins to re-wind upon the barrel as the descending rope begins to preponderate over the ascending rope.

Taking all these conditions into account, the engine will be found, in regular working duty, to be giving out a power varying from 400 to 450 horse-power.

---

The following paper by Mr. BENJAMIN FOTHERGILL, of Manchester, was next read:—

*On an improved water-meter.*

Amongst the various objects to which men of mechanical genius have directed their attention for many years, that of producing a machine for accurately measuring the flow of water, has been considered a great desideratum; and amongst the number which have been submitted to the public, that of Mr. Thomas Taylor, of Man-

chester, forming the subject of the present paper, appears to contain all the essentials of a complete and correct meter.

A meter is required to sustain the greatest pressure,—the flow must not be interfered with by obstruction or friction, so as to hinder its ascent to the highest point of its source,—it must measure correctly under every variety of pressure, and when subdued to the smallest amount of inlet must indicate the quantity passing through the meter,—and durability or non-liability to wear and tear must be an important feature, without which the machine would be of little value.

In Mr. Taylor's patented meter these properties are combined. In constructing his meter he first determined the area of the pipe through which the water was to flow (say equal to two inches diameter), and in the next place the circumference of the wheel or drum that was designed to move simultaneously with the flow of water (say 24 inches circumference). The next question was, how much water will a 2-inch pipe contain in 24 inches length; and supposing this to be one gallon, then in that case every revolution of the wheel or drum would indicate one gallon as having passed through: ten revolutions would be ten gallons, and so on; the index being set so as to register the exact quantity passing through the meter at each revolution. [The specification of this meter being given in page 17, *ante*, we have omitted the details of its construction in this place.]

Mr. Fothergill shewed the meeting one of the meters in operation, which had been brought by Mr. Taylor for the purpose; and exhibited separate specimens of the gutta-percha drum and regulating valve. He observed that the friction of the drum was very small, as its weight was all supported by the water,—being adjusted to the same specific gravity as the water; and the resistance from friction of the wheel-work, and the stuffing-box for the spindle at the side of the meter, would be very slight, on account of the great leverage over it at which the water acted on the circumference of the drum. There was consequently so exceedingly small a resistance to be overcome in making the drum revolve, that the smallest stream of water impinging on the drum and flowing round its circumference, was sufficient to overcome its inertia, and cause it to rotate with a velocity proportionate to the quantity of water discharged, being the amount of moving force. The velocity with which the circumference of the drum revolved, was consequently a correct measure of the quantity of water discharged upon it; and this had been found to be the case in practice; for all the meters had been worked under very extreme differences, both in pressure and in velocity of discharge, and those he had examined or was acquainted with had proved correct in measurement throughout. The meters had been used with great advantage to measure the quantity of water supplied to boilers, so as to ascertain correctly the water evaporated by the coals consumed, which was

important information in reference to economy of working, and could only be satisfactorily ascertained by means of such a meter.

Mr. Thompson said he had had three of the meters at work for several months in Manchester: one a large meter to measure the water raised into a 3000-gallon cistern, and two others employed to measure the water supplied to boilers. He had tested the meters regularly once a week for some time, and found that they uniformly registered correctly within one half per cent.: they had kept in good order, and gave entire satisfaction.

The Chairman remarked that he had recently witnessed a trial of the meter with several members of the Institution, in which the meter was connected to a cistern containing 100 gallons of water to about  $\frac{1}{2}$  inch depth. The register of the meter was found to be correct for each 100 gallons drawn from the cistern, both when running full bore, and when discharging only by a very small stream. The meter appeared, therefore, to be accurate under both extremes; and he thought it was a very ingenious invention, and had an important advantage in the simplicity of construction.

Mr. Perring said he had tried a series of experiments on four different meters, and this was the only one that he found not to fail in registering the quantity of water when discharged in a very small stream.

---

The following paper, by Mr. EDWARD JONES, of Liverpool, was then read:—

*On the American dry clay brick-making machine.*

This machine, the invention of Mr. Culbertson, of Philadelphia, is one of the numerous American inventions imported into this country, and has been worked in a most satisfactory manner, for a considerable period, in several parts of the United States.

The machine is mounted on a strong cast-iron frame, fixed to a brick or stone foundation, and consists of a mould-carriage, containing 14 moulds, each provided with a moveable bottom, with stems projecting through the carriage; by means of which, and lifting-bars, the bricks are raised from the moulds, as the lifting-bars are carried up inclines on friction-rollers by the forward motion of the mould-carriage. At the outside of this carriage are slides for bearing off the bricks. To the bottom of the mould-carriage, a rack, worked by a spur-wheel, is bolted; and, fitting close on to the face of the mould-carriage, and secured to the frame, is a clay box, bolted to the hopper, inside of which is a press-wheel for squeezing the clay into the moulds. In order to sustain the pressure on the mould-carriage there are bearing-wheels to support the same. Keyed to the shaft of the bearing-wheel is a spur-wheel, working into another spur-wheel of similar diameter, which causes the press-wheel and mould-carriage to travel at uniform rates. An internal and external spur-wheel,

working into a pinion, on a vibrating shaft, produces a reciprocating motion of the mould-carriage. There is likewise a steam-pipe provided, which can be used, if found necessary, to warm the press-wheel, which is cast hollow, to prevent the clay adhering to the surface.

This machine enables the manufacturer to continue his operations during the whole of the year, as the clay used is in a semi-dry state, or just as it is dug from the ground, and the bricks, when made, are taken direct from the mill to the kiln.

The machine is self-feeding and self-delivering, and will, with ease, turn out 25,000 bricks per day,—harder, smoother, and containing less water than when made by hand, and at a much less cost. Instead of the present mode of casting, tempering, weathering, &c., the clay is taken direct from the bank to a pair of rolls running at different velocities, so as to break it up thoroughly, and from thence to the mill by means of elevators or other mechanical appliances.

The pressure upon the clay in the machine is gradual and continuous, allowing the air to escape freely as the clay is forced into the mould; and as each mould passes twice under the cylinder, receiving clay from the hopper each way, the brick is made full and perfect in all its edges.

Bricks of any shape can be made with this machine by using suitable moulds.

In a commercial point of view, the following statement will shew the value of the invention.

The present prices of brick-making in Lancashire are—Casting, 10*d.*; faying, 2*d.*; moulding, 1*s.* 8*d.*; tempering, 1*s.* 8*d.*; wheeling off and walling, 1*s.* 8*d.*; carrying off 9*d.*;—making a total of 6*s.* 9*d.* per 1000.

Taking the working days at 250 in the year, an average of 25,000 per day is equal to 6,250,000 per year; costing at 6*s.* 9*d.* per 1000, £2104. 7*s.* 6*d.*

By means of the machine we have :—First cost, including steam-engine, foundation, crushing-rolls, and all other machinery required, £1400.

	£.	s.	d.
This, at 15 per cent. for interest and depreciation, is . . . . .	210	0	0
Coal, oil, and engine driver, for 250 days . . . . .	190	0	0
Getting clay and wheeling to rolls . . . . .	190	0	0
Wheeling off and attending to machine . . . . .	200	0	0
Incidentals . . . . .	50	0	0
	<hr/>		
	£840	0	0

or 2*s.* 8½*d.* per thousand,—or a gross amount of saving of £1264. 7*s.* 6*d.* on the year's work; being nearly the entire cost of the whole of the machinery and buildings.

## LIST OF GRANTS OF PROVISIONAL PROTECTION.

[Cases in which a full Specification has been deposited.]

1153. John Cox, of Birmingham, for improvements in the manufacture of percussion caps.—[Dated May 23rd.]  
 1257. Nehemiah Brough, of Birmingham, for improvements in the manufacture of buttons, and in attaching them to articles of wearing apparel.—[Dated June 6th.]

[Cases in which a Provisional Specification has been deposited.]

406. William Melville, of Roebank Works, Lochwinnoch, for improvements in printing textile fabrics and other surfaces.—[Dated February 20th.]  
 450. William Macnab, of Greenock, for improvements in steam-engines of the class usually termed trunk engines.—[Dated February 24th.]  
 500. Simon Roussel, of Rue Caumartin, Paris, for a new system of painting and colouring glass; being an imitation of old and new church window glasses, called "Typophanic."—[Dated March 1st.]  
 536. Andrew Barclay, of Kilmarnock, for improvements in condensing steam-engines.—[Dated March 6th.]  
 554. Louis Jean Barnetche, of Bordeaux, for improvements applicable to the prevention of accidents on railways.—[Dated March 8th.]  
 562. James Smith, of Liverpool, for improvements in baking ovens.—[Dated March 9th.]  
 638. Thornton John Herapath, of Bristol, for improvements in the manufacture of manure from sewage; which are also applicable to the preparation of other artificial manures.—[Dated March 17th.]  
 658. Claude Adrien Bernard Chenot, of Paris, for improvements in the manufacture of steel, iron, and different alloys, cast, welded, and moulded.—[Dated March 20th.]  
 686. Moses Poole, of Avenue-road, Regent's-park, for improvements in preventing alterations of bank notes, cheques and other documents,—a communication.—[Dated March 23rd.]  
 710. George Collier, of Halifax, for improvements in looms for weaving terry and cut pile fabrics.—[Dated March 27th.]  
 724. Frederick William Harrison and Henry Graham William Wagstaff, of Pollard's-row, Bethnal-green, for an improvement in the construction of wicks for candles.—[Dated March 29th.]  
 748. Auguste Edouard Loradoux Belford, of Castle-street, for certain improvements in breech-loading fire-arms,—being a communication.—[Dated April 1st.]  
 782. James Howden, of Glasgow, for improvements in the manufacture of rivets, bolts, spikes, screw-blanks, and similar articles.—[Dated April 5th.]

827. John Platt, of Oldham, for certain improvements in machinery for preparing cotton.—[*Dated April 8th.*]  
846. James Childs, of Belmont, Vauxhall, for an improvement in subjecting fatty and oily matters, and matter containing oils or fats, to pressure.  
850. Thomas Schofield Whitworth, of Salford, for improvements in the mule for spinning and doubling cotton and other fibrous materials.

*The above bear date April 11th.*

892. John Rowley, of Camberwell, for improvements in the manufacture of a material as a substitute for leather.—[*Dated April 18th.*]  
969. Christopher Kingsford, of Buckingham-street, Strand, for improvements for solidifying or indurating peat, soft, small, or pulverized coal, and other substances of a like oleaginous or bituminous nature, and machinery and apparatus for effecting the same.—[*Dated April 29th.*]  
972. William Alfred Waddington, of Stonegate, York, for certain improvements in the construction of sounding boards for pianofortes and other like stringed instruments.  
973. William Augustus Archbald, of Stanhope-street, Gloucester-gate, for improvements in the manufacture of concrete cane-juice and sugar.

*The above bear date May 1st.*

980. William Hutton, of Portland Town, St. John's Wood, for an improved machine for the manufacture of bricks.  
986. Robert James Mary'on, of York-road, Lambeth, for certain improvements in the construction of and manufacture of anchors.

*The above bear date May 2nd.*

998. Cornelia Mee, of Bath, for an improved foundation for working out ornamental designs or patterns.  
1000. Charles Barlow, of Chancery-lane, for improvements in meters for accurately measuring water and other fluids discharged from pipes, sluices, or vessels,—being a communication.  
1002. John Manley, of Chacewater, Cornwall, for an improvement in ventilation, and in treating smoke so as to prevent the ascent of the denser particles thereof into the atmosphere.

*The above bear date May 4th.*

1004. William Exall, of Reading, for improvements in machines for cutting straw and other such materials.  
1006. Edwin Haseler, of Wolverhampton, for an improvement or improvements in ornamenting metals, papier-mâché, horn, and shell.  
1008. Antoine Marie Philibert Barbette, of Paris, for improvements in the manufacture of brass-topped nails.



1010. Arthur Warner, of New Broad-street, for improvements in the manufacture of metal sheets for sheathing ships and other vessels, and for other uses.

*The above bear date May 5th.*

1020. Ralph Bulkley, of New York, for the extinguishment of fires in steamers, vessels, houses, and buildings of all descriptions.

1022. John Henry Johnson, of Lincoln's-inn-fields, for improvements in the construction of railway carriages,—being a communication.

1024. Julian Bernard, of Club-chambers, Regent-street, for improvements in machinery or apparatus for sewing, stitching, or ornamenting.

*The above bear date May 6th.*

1025. John Jefferis, of the Grove, Southwark, for certain improvements in packing for pistons, piston-rods, pumps, joints of pipes, and other like purposes.

1026. Carl Pferdorff, of South-row, Kensall New Town, for a new toy or aerial top.

1027. Henry Moore Naylor, of Birmingham, for a new or improved instrument for cutting various articles of food.

1028. George Fox Logan, of Glasgow, for improvements in templates, to be used in constructing iron ships, boats, boilers, and other metallic structures.

1029. George Barry Goodman, of Salisbury-place, New-road, for improvements in apparatus for holding together letters, music, and other loose sheets,—being a communication.

1030. George Thomas, of Osaburg-street, Regent's-park, for improvements in the construction of the framework of upright piano-fortes.

1031. Théodore Lemielle, of Bruxelles, for improved apparatus applicable to the ventilation of mines, buildings, and other places.

1032. Charles Benjamin Normand, of Havre, for improved machinery for sawing wood.

*The above bear date May 8th.*

1033. William Bridges Adams, of Adam-street, Adelphi, for improvements in rails for railways, and modes of connecting and fixing them.

1034. Francis Peter Berquez, of Richmond-road, Dalston, for improvements in gas cooking and heating stoves, and in generating heat therefor.

1035. Charles Liddell, of Abingdon-street, Westminster, for improvements in moving boats on canals and rivers.

1036. Charles Liddell, of Abingdon-street, for improvements in the permanent way of railways.

1037. Alfred Vincent Newton, of the Office for Patents, 66 Chancery-lane, for improvements in the manufacture of artificial stone for building and other purposes,—being a communication.  
1038. Eben Norton Horsford, of Massachusetts, U. S., for the removal of chlorine from substances and fabrics.

*The above bear date May 9th.*

1039. William Coles Fuller, of Bucklersbury, for certain improvements in the adaptation of India-rubber springs.  
1040. Pehr Ambjorn Sparre, of Salisbury-street, Strand, for an improved mode of preventing the alteration or falsification of written documents.  
1042. Rees Reece, of Athy, for the smelting of iron by means of turf or peat, simultaneously with the combustion of the peat and collection of the products therefrom.  
1043. William Williams, of Dublin, for an improved propeller.  
1044. John Anthony and William Treeby Chafe, both of Devonport, for an improvement in machinery for the manufacture of pipes and tubes from lead and other soft metals and alloys.  
1045. John Lawson, of Glasgow, for improvements in drawing ships out of water,—being a communication.

*The above bear date May 10th.*

1047. Ezra Miles, of Stoke Hammond, Bucks, for an improved coupling-joint or connection for tubing or other purposes.  
1048. Edward Brown, of Sheffield, for improvements in the manufacture of scissors from steel and other metals.  
1050. John Cundy, of Carrington, Nottingham, for an improved reflector globe or shade for gas, candle, oil, and other artificial light.  
1051. Warren de la Rue, of Bunhill-row, for improvements in distillation.  
1052. Henry Doulton, of High-street, Lambeth, for improvements in kilns used in the manufacture of stoneware, earthenware, and china.  
1053. Alfred Vincent Newton, of the Office for Patents, Chancery-lane, for an improvement in the construction of carriage-wheels, and in the mode of mounting them on their axles,—being a communication.  
1054. Edward William Abbott, of Regent's Quadrant, for certain improvements applicable to the manufacture of umbrellas and parasols, and cases for containing the same.

*The above bear date May 11th.*

1055. John Platt, of Oldham, for certain improvements in apparatus or machines for forging, drawing, moulding, or forming spindles, rollers, bolts, and various other articles in metal.  
1056. Josiah Penton and James Mackay, both of Chippenham, for certain improvements in the construction of railway wheels and tyres.

1057. William Waite, of Gloucester-street, Regent's-park, for an improvement applicable to the construction of sewers, drains, and pipes, for the conveyance of sewage, water, or gas.
1058. Christopher Nugent Nixon, of Ramsgate, for improved modes of attaching rudders to floating vessels.
1059. Daniel Campbell and James Barlow, of Accrington, for improvements in looms for weaving.
1060. Thomas Littleton Holt, of Warwick-square, and William Charlton Forster, of Hatton-garden, for making paper.
1061. Henry Crowley, of Manchester, for improvements in machinery for grinding bones,—being a communication.
1062. Moses Poole, of Avenue-road, Regent's-park, for improvements in machinery for splitting leather,—being a communication.
1063. Charles William Feuillade Aubusson, of Warren-street, Fitzroy-square, for an improvement in ferrules.
1064. Moses Poole, of the Avenue-road, Regent's-park, for improvements in engraving and printing on glass, and of figuring and ornamenting the same,—being a communication.
1065. Moses Poole, of the Avenue-road, Regent's-park, for improvements in fire-arms,—being a communication.
1066. Auguste Edouard Loradoux Bellford, of Castle-street, for an improved method of retarding the process of decay in flour, meal, grain, and other vegetable substances,—being a communication.
1067. Auguste Edouard Loradoux Bellford, of Castle-street, for certain improvements in carriage-axles and their boxes,—being a communication.
1068. William King Westly, of Leeds, for an improved construction of railway and carriages to be employed thereon, applicable chiefly to farm purposes.
1069. Frederick Shand Hemming, of Woodside, Birkenhead, for improvements in the manufacture of iron houses; part of which improvements is applicable also to the construction of sheds and fences.
1070. Frederick Smith, of York-street, Lambeth, for an improved arrangement of furnace for consuming smoke.
1071. Alfred Vincent Newton, of the Office for Patents, Chancery-lane, for an improved mode of separating granular substances of different degrees of fineness,—being a communication.

*The above bear date May 12th.*

1072. Eugène Barsanti, and Felix Matteucci, both of Florence, for a new or improved mode of applying the explosion of gases as a motive power.
1073. Jérôme André Drieu, of Patricroft, for certain improvements in machinery or apparatus for cutting fustians, velveteens, and other similar fabrics, to produce a piled surface.
1074. Charles Garforth, of Dukinfield, for certain improvements

- in apparatus to be employed in the construction of the permanent way of railways.
1075. Richard Clarke Burleigh, of Northumberland-street, Charing-cross, for certain improvements in steam-engines and other engines worked by the pressure of gaseous or other fluids, which are also applicable to pumps.
1076. Thomas George Shaw, of Old Broad-street, for improvements in apparatus to facilitate the decanting of wine and other liquids.
1077. Henry Heathcote Russell, of York-buildings, Adelphi, for an improved and ready mode of coupling, connecting, or joining.
1078. Henry Young Darracott Scott, of Queen's-terrace, Woolwich, for an improved cement applicable as a plaster, or for moulding purposes.

*The above bear date May 13th.*

1079. Joseph Valentin Henry de Ste. Marie, of Paris, for certain improvements in the means and apparatus for fixing capsules on bottles, vessels, or flacons.
1080. Louis François Saugrin, of Paris, for improvements in apparatus for the production of stereoscopic and photographic pictures.
1081. Richard Archibald Brooman, of Fleet-street, for improvements in the manufacture of wheels for railway carriages,—being a communication.
1082. Richard Scott and Thomas Rowland, both of Basford, Nottinghamshire, for improvements in machinery employed in the manufacture of knitted fabrics.
1083. Paul Prince, of Derby, for retarding railway trains on the approach of danger, and for other purposes.
1084. John Chedghey, of the Grove, Southwark, for an improved manufacture of rollers and cylinders, applicable to various kinds of machinery where a smooth, hard, and regular surface is required.
1085. William Edward Newton, of the Office for Patents, Chancery-lane, for improved machinery for cutting or shaping wood or other materials,—being a communication.

*The above bear date May 15th.*

1087. Thomas William Miller, of Southsea, Hants, for improvements in railway sleepers.
1088. George Edward Dering, of Lockleys, Herts, for improvements in obtaining motive power by electricity.
1089. Anguish Honour Augustus Durant, of Tong Castle, Salop, for improvements in apparatus for sweeping chimneys and flues, and for extinguishing fires therein.
1090. Thomas William Miller, of Southsea, Hants, for improvements in railway sleepers.

1091. George Manwaring and William Alltoft Summers, both of Southampton, for improvements for supplying water for water-closets, for the flushing of drains, and for general purposes.
1092. James Philip Baker, of Chillington Colliery, Wolverhampton, for improvements in the construction of railway and other bridges, and in the method of lifting the same after sinking.

*The above bear date May 16th.*

1093. William Smith and William Bramwell Hayes, both of Manchester, for certain improvements in power looms for weaving.
1094. Rice Harris and Rice Williams Harris, both of Birmingham, for improvements in the manufacture of articles in glass.
1095. George Cheadle, of Wolverhampton, for a new or improved lubricating composition.
1096. Henry Cornforth, of Birmingham, for an improvement or improvements in shaping and ornamenting metals.
1098. Alfred Vincent Newton, of the Office for Patents, Chancery-lane, for an improved construction of tenon and of machinery for forming the same; applicable to the manufacture of boxes and analogous uses,—being a communication.
1099. Christopher Catlow, of Clitheroe, and Thomas Comstive, of Burnley, for improvements in shuttles for weaving.
1100. Squire Diggle, of Radcliffe, for improvements in looms for weaving.
1101. Lionel John Wetherell, of Percival-street, Clerkenwell, and Augustus Johann Hoffstaedt, of Albion-place, Surrey, for an improved construction of pump.

*The above bear date May 17th.*

1102. William Coulson, of Fetter-lane, York, for improvements in machinery for morticing and tenoning.
1103. Jonathan Worthington, of Llancaich and Gilvach Main Collieries, near Cardiff, and Fennell Allman, of Adam-street, Adelphi, for certain improvements in boring, mining, and blasting, and in the apparatus connected therewith.
1104. James Horsfall, of Birmingham, for an improvement or improvements in the manufacture of wire for piano-fortes and other musical instruments.
1105. John Beads, of Pendleton, for improvements in machinery or apparatus for preparing, spinning, doubling, and twisting cotton, woollen, silk, linen, or other yarns.
1106. Thomas Chambers Hine, of Regent-street, Nottingham, for a new method of applying glass in the ornamentation of chandeliers and other fittings required for gas, candle, oil, or other artificial light.
1107. William Miller, of Musselburgh, Midlothian, for improvements in bleaching flax, hemp, and other fibrous substances.

1108. Oliver Maggs, of Bourton, Dorsetshire, for an improvement in applying shafts to agricultural implements and carriages.
1109. James Colley March, of Barnstaple, for improvements in vices.
1110. John Henry Johnson, of Lincoln's Inn Fields, for improvements in printing telegraphs,—being a communication.
1111. John Maclean, jun., and Thomas Finlayson, both of Glasgow, for improvements in the manufacture or production of ornamental fabrics.
1113. James Curle Robertson, of Glasgow, for improvements in the preparation and roasting of coffee and other substances.
1114. Joseph Hinchliffe, jun., of Dam Side, near Halifax, for certain improvements in apparatus for regulating or governing the speed of steam-engines.
1115. Charles Barlow, of Chancery-lane, for improvements in the manufacture of metallic capsules for covering or securing bottles and other vessels,—being a communication.
1116. John Cunningham and William Ashley, both of Liverpool, for improved apparatus for ventilating ships.
1117. Edouard Auguste Désiré Guichard, of Paris, for improvements in the manufacture of ornamental fabrics for decorating walls or other surfaces.

*The above bear date May 18th.*

1118. Johann August Haberhauffe, of Grossmuhlingen, Anhalt, for improvements in fire-arms and projectile weapons.
1119. Etienne Jacques Feuillatre, of Paris, for an improved apparatus for cleansing the wheels of carriages.
1120. Peter Armand le Comte de Fontainemoreau, of South-street, for improvements in connecting the permanent rails of railways,—being a communication.
1121. Thomas Murray Gladstone, of the Irwell Works, Salford, for an improved traverser or machine for shifting railway carriages from one set of rails to another.
1122. Christopher Rands, of the Steam Flour Mills, Shad Thames, for certain improvements in machinery for regulating the feed of millstones.

*The above bear date May 19th.*

1123. Thomas Alletson, of Moorgate-street, for improvements in the construction of flues and chimneys for steam-engine boiler furnaces and other furnaces.
1124. Kosman Rose, of Commercial-road, Stepney, for improvements in buttons.
1125. Auguste Edouard Loradoux Belford, of Castle-street, for certain improvements in looms for weaving,—being a communication.
1126. Auguste Edouard Loradoux Belford, of Castle-street, for certain improvements in piano-fortes,—being a communication.
1127. William Church, of Birmingham, for a new or improved projectile.

1128. William Crighton and Andrew Crighton, both of Manchester, for improvements in machinery or apparatus technically called "beaters," used for opening, cleaning, or otherwise preparing cotton, wool, or other fibrous substances.
1129. Robert Crosland, William Holiday, and John Heaton, all of Bradford, Yorkshire, for improvements in apparatus employed in the manufacture of cast metal pipes or tubes.
1130. John Crossley, of Newton Moor, near Hyde, and William Crossley, of Failsworth, for improvements in Jacquard machines.
1131. John Blake, of Greenock, for an improved shackle-hook.
1132. Robert Anstruther Balbirnie, of Great Malvern, for an improved mode of mounting ships' compasses,—being a communication.
1134. William England, of Dudley, for improvements in pneumatic and hydraulic wheels and fans.
1135. Louis Sautter, of Paris, for improvements in lighthouses, and in lamps for lighthouses and other places.
1136. Henry S. Rogers, of New Oxford-street, for improvements in fire-arms,—being a communication.
1137. Frederick Clark, of King-street, Whitehall, for an improvement in fixing the spindles of door and other knobs and handles.
1138. André Prosper Rochette, of Brighouse, Yorkshire, for an improvement in the manufacture of soap.
1139. Joseph Blakey Spencer, of the Shooter's Hill-road, and Arthur James Melhuish, of Bowater-place, Shooter's Hill-road, for improvements in photographic apparatus.
1140. Robert Oram and William Oram, both of Salford, for certain improvements in hydraulic presses.
1141. Charles Bostock and Stephen Greenwood, both of Manchester, for certain improvements in machinery or apparatus for cleaning and doubling silk.
1142. Thomas Storey, of the Phoenix Foundry, Lancaster, for improvements in stench traps.

*The above bear date May 22nd.*

1143. Thomas William Atlee and George Jobson Atlee, both of Birmingham, for improvements in printed or other forms, applicable for bankers' cheques, orders for goods, wharfingers and carriers' receipts, taxes and rates collectors' receipts, and various other parochial, commercial, or private purposes, whether such forms be bound up into books or not.
1144. Frederick Jenks, of Handsworth, and Thomas Brown, of Birmingham, for an improvement or improvements in saddle-trees.
1145. John Biggs, of Ightham, Kent, for an improvement in the mariner's and other compasses by isolating and rendering them insensible to the disturbing influence of local attraction of iron, steel, and other bodies.

- 1146. William White, of Cheapside, for improvements in hats and in hat blocks.
- 1148. Ernest Radigon and Raimond Gabriel de Grimouville, both of Paris, for certain improvements in glasses, shades, and smoke-plates, used in gas and other lighting.
- 1149. Joseph Kuczynski, of Rue de Rivoli, Paris, for improvements in preparing baryta and its salts.
- 1150. Robert Reyburn, of Baker-street, Greenock, for improvements in refining sugar.
- 1151. Charles Levey, of Little Queen-street, Lincoln's-inn-fields, for improvements in weaving bags and other tubular fabrics.
- 1152. John Lawson, of Sidmouth-street, Gray's-Inn-road, for improvements in the manufacture of cut-pile fabrics.
- 1154. James Livesey, of Bury, for improvements in machinery for preparing or forming slivers of cotton, wool, and other fibrous materials, for spinning or other purposes.
- 1156. Julius Smith, of Henry-place, Bride-street, and Frank Sandom Thomas, of South-terrace, Walworth, for improvements in steering ships and other vessels.

*The above bear date May 23rd.*

- 1157. Frederick Lipscombe, of the Strand, for improvements in guiding ships and boats.
- 1158. Joseph Lillie, of Manchester, for improvements in looms for weaving.
- 1159. Thomas Clarendon and Owen John Gilson, both of Dublin, for improvements in the means or apparatus for working brakes on railway carriages.
- 1160. Thomas Ball, of Nottingham, for an improvement in manufacturing ornamented looped fabrics.
- 1161. Josiah George Jennings, of Great Charlotte-street, Blackfriars, and Robert Davenport, of Jonathan-street, Vauxhall, for improvements in the construction of kilns for burning pottery and other ware.

*The above bear date May 24th.*

- 1162. Edward Onslow Aston and George Germaine, both of Millwall, for improvements in mariners' compasses to counteract the effects of local attraction.
- 1163. Jean Marie Chevron and Charles Victor Frederic de Roulet, both of Paris, for improvements in textile fabrics and in machinery for manufacturing such fabrics.
- 1164. Joseph Harrison of Fitzroy-square, for improvements in piano-fortes.
- 1165. Edward Everall and Thomas Jones, both of Henrietta-street, Brunswick-square, for waterproofing all kinds of cloth, clothing, silk, and leather, without injury to their respiratory properties, flexibility of fabric, color, or appearance.
- 1166. Edouard Cari Mantrand, of Paris, for improvements in the manufacture of phosphorus.



1167. Louis Michel François Doyere, of Paris, for improvements in purifying grain.
1168. John William Jeakes, of Great Russell-street, for an improved construction of stove-grate.
1169. John Packham, of Western-road, Brighton, for improvements in boilers used for heating and circulating water.
1170. John McGaffin, of Liverpool, for improvements in metal casks and tanks.

*The above bear date May 25th.*

1171. Allan Livingston, jun., of Portobello, for improvements in earthenware pipes for drains and sewers.
1172. Joseph Albert Corwin, of Newark, New Jersey, for improvements in knitting machinery.
1173. Gardner Chilson, of Boston, U.S., for a new or improved furnace or heat-generator and radiator, to be used for warming buildings or apartments, or for various other useful purposes.
1174. Samuel Sweetser, of Massachusetts, U.S., for an improvement in preparing skins or hides for the application of tannin thereto or for being tanned,—being a communication.
1175. Mahlon Loomis, of Massachusetts, U.S., for an improvement in the manufacture of artificial teeth.
1176. William Gossage, of Widnes, Lancashire, for improvements in smelting or reducing copper ores and certain other metallic compounds.

*The above bear date May 26th.*

1178. Henry Distin, of Cranbourn-street, Leicester-square, for improvements in drums for musical purposes, and in the mode of supporting and keeping them in the required position when in use,—being a communication.
1179. Julius Schmoock, of Oxford-street, for improvements in the construction of children's and other carriages moved by manual power.
1180. Joseph Hipkiss, of Dudley Port, Staffordshire, for an improvement or improvements in puddling furnaces used in the manufacture of iron.
1181. James Murdoch, of Staple-inn, for improvements in toy pistols,—being a communication.
1182. William Stenson, jun., of Whitwick Collieries, near Ashby-de-la-Zouch, for improvements in steam-engine valves.

*The above bear date May 27th.*

1183. John Stevenson, of Graslees, near Elsdon, Northumberland, for improvements in ploughs.
1184. Thomas Bazley, of Manchester, for improvements in, and applicable to, furnaces and vessels used in connection therewith for the manufacture of glass.
1185. Henry Kraut, of Zurich, for certain apparatus applicable to cocks, taps, and valves.

1186. John Evans, of Abbots Langley, for improvements in the manufacture of ornamental paper and paper bands.
1187. Charles James Pownall, of Kensington, for an improvement in communicating intelligence from one part of a railway train to another.
1188. Thomas Taylor, of Eddingley, Nottinghamshire, for improvements in machinery or apparatus for distributing manure and vegetable substances.
1190. Andrieu Ernest Sablons, of South-street, for certain improvements in the construction of trunks, travelling boxes, portmanteaus, and other similar receptacles.

*The above bear date May 29th.*

1191. Joseph Ridsdale, of the Minories, for improved means or methods of communicating between different parts of ships and other vessels.
1192. Francis Mordan, of Frederick-place, Goswell-street-road, for an improved ink-stand,—being a communication.
1195. Edouard Heinhold, of Paris, for improvements in diurnal and nocturnal indicating apparatus.
1196. Henry Doulton, of High-street, Lambeth, for an improvement in the manufacture of junctions for sewers and drains.
1197. Michael Scott, of Great George-street, Westminster, for improvements in joining or connecting pipes.
1198. Lewis Stirling Middleton, of Glasgow, for improvements in the manufacture or production of ornamental fabrics.
1199. Leopold Wertheimer, of Paris, for improvements in apparatus for preventing sea sickness.

*The above bear date May 30th.*

---



---

### **List of Patents**

*Granted for SCOTLAND, from the 16th February, to the 22nd June, 1854.*

- To Joseph Burch, of Crag Works, Macclesfield, for improvements in printing and ornamenting cut-pile and other fabrics and yarns.—Sealed 2nd March.
- Joseph Burch, of Crag Works, Macclesfield, for improvements in printing terry and pile carpets, woollen, silk, and other materials.—Sealed 2nd March.
- William Edward Newton, of the Office for Patents, Chancery-lane, for improvements in casting type,—being a communication.—Sealed 29th May.

**New Patents.***Sealed under Patent Law Amendment Act, 1853.*

- |  |  |
|--|--|
| 2532. T. S. Bale and D. Lucas.                         | 2898. Edward Beanes.                             |
| 2652. J. R. Musgrave, R. Musgrave,<br>and J. Musgrave. | 2904. W. B. Johnson.                             |
| 2720. H. R. Abraham.                                   | 2905. E. H. Rascol.                              |
| 2728. W. B. Johnson.                                   | 2911. A. B. Callier.                             |
| 2748. J. H. Johnson.                                   | 2912. J. B. Pascal.                              |
| 2755. J. Wormald and G. Pollard.                       | 2913. F. W. Branston.                            |
| 2762. Louis Cornides.                                  | 2915. Benjamin Whitaker.                         |
| 2769. R. H. Nicholls.                                  | 2922. Antoine Limousin.                          |
| 2772. Alexander Macomie.                               | 2924. Thomas Williams.                           |
| 2775. Patrick Kelly.                                   | 2934. A. L. Knox.                                |
| 2778. A. E. L. Belford.                                | 2935. Henry Thomson.                             |
| 2781. Joshua Jackson.                                  | 2936. R. W. Waithman.                            |
| 2784. E. K. Davis.                                     | 2937. J. S. Bailey.                              |
| 2785. John Hewitt.                                     | 2938. Joshua Horton.                             |
| 2787. Richard Balderstone.                             | 2939. George Anderson.                           |
| 2788. John Patterson.                                  | 2943. Isaac James.                               |
| 2790. Lewis Jennings.                                  | 2944. M. P. Houghton and Andrew<br>Stewart.      |
| 2793. T. Garnett and D. Adamson.                       | 2945. James S. Cockings.                         |
| 2799. J. H. Johnson.                                   | 2954. Adam Paterson.                             |
| 2800. James Reilly.                                    | 2957. Henriette Durut.                           |
| 2804. Alexander Brown.                                 | 2959. James Boydell.                             |
| 2816. William Dray.                                    | 2964. Archibald Thomson.                         |
| 2820. Squier Cheavin.                                  | 2965. R. B. Huygens.                             |
| 2824. John Patterson.                                  | 2966. Gottlieb Boccins.                          |
| 2828. Edward Oldfield.                                 | 2968. H. Kohnstamm.                              |
| 2829. J. C. Haddan.                                    | 2971. John Jones.                                |
| 2831. A. E. L. Belford.                                | 2977. Charles Lewis.                             |
| 2832. G. Ross and J. Inglis.                           | 2978. Benjamin Murgatroyd.                       |
| 2845. W. B. Adams.                                     | 2979. T. Berry, J. Mangnall, and<br>J. Chadwick. |
| 2846. W. T. Henley.                                    | 2981. Joseph Shaw.                               |
| 2853. James Beall.                                     | 2986. J. D. Pfeiffer.                            |
| 2858. J. B. E. Rüttré.                                 | 2988. Joseph Gaultier.                           |
| 2861. D. Christie and J. Cullen.                       | 2991. H. Harding.                                |
| 2862. Andrew Shanks.                                   | 2993. Joseph Lewis.                              |
| 2865. R. Eccles, J. Mason, and L.<br>Kaberry.          | 2995. T. W. Makin.                               |
| 2866. James Sutcliffe.                                 | 2996. E. J. Hughes.                              |
| 2869. J. H. Johnson.                                   | 3002. John Parkinson.                            |
| 2872. William Schaeffer.                               | 3018. James White.                               |
| 2873. John Bourne.                                     | 3027. James Marlor.                              |
| 2874. John Bourne.                                     | 3028. Walter Mabon.                              |
| 2876. Allan Macpherson.                                | 3030. John Milner.                               |
| 2879. H. L. Du Bost.                                   | 3037. Joseph Holbrey.                            |
| 2881. J. H. Johnson.                                   | 3039. J. Bernard.                                |
| 2883. N. V. Guibert.                                   | 3044. F. A. Clerville.                           |
| 2885. E. O. W. Whitehouse.                             | 3045. S. T. M. Sorel.<br>1854.                   |
| 2888. Wm. Redgrave.                                    | 9. Joseph Madeley.                               |
| 2889. G. K. Hannay.                                    | 14. John Collins.                                |
| 2890. James Wansbrough.                                | 15. J. J. Grylls.                                |
| 2892. Christian Schiele.                               | 22. E. Schischkar & F. C. Calvert.               |
| 2895. Phillip Grant.                                   | 24. J. H. Johnson.                               |
| 2897. J. A. Coffey.                                    |  |

26. L. J. Pomme.  
 36. A. V. Newton.  
 45. Benjamin Burleigh.  
 49. W. and J. Garforth.  
 60. Adolphe Drevelle.  
 61. W. L. Tizard.  
 80. John Bethell.  
 83. A. E. L. Bellford.  
 111. Henry Corlett.  
 114. W. B. Haigh.  
 121. Edmund Sharpe.  
 123. Robert Galloway.  
 126. G. H. Bursill.  
 129. John Norton.  
 130. Thomas Webb.  
 133. Francis Parkes.  
 137. H. B. Condry.  
 138. Edward Aitchison.  
 139. A. E. L. Bellford.  
 151. H. E. Falk.  
 161. M. A. Muir.  
 167. John Westlake.  
 219. P. A. Le Comte de Fontaine-  
 moreau.  
 220. P. A. Le Comte de Fontaine-  
 moreau.  
 229. Robert Chapman.  
 243. R. A. Brooman.  
 250. John Burgum.  
 259. Joseph Beattie.  
 284. Dominiques Deyres.  
 290. Andrew Duncan.  
 323. S. Hunt and T. Morris.  
 325. B. H. Hine, A. J. Mundella,  
 and L. Barton.  
 354. William Scaling.  
 368. John Wren.  
 387. E. Rowland and J. Rowland.  
 397. W. H. Barlow.  
 423. Edward Massey.  
 431. James Boydell.  
 457. A. E. L. Bellford.  
 486. Wm. Patten.  
 499. J. B. Gottung.  
 580. William Mill.  
 594. J. J. Aston.  
 624. A. E. P. Le Gros.  
 631. F. W. Emerson.  
 640. Alexander Hendry.  
 663. James Young.  
 670. A. V. Newton.  
 679. W. D. Skelton.  
 680. R. O. White.  
 689. Stephen Holman.  
 691. H. Room and W. Morton.  
 694. Samuel Humphreys.  
 702. T. J. Smith and J. Smith.  
 709. J. A. Manning.  
 718. F. Chambon and A. Meyniac.  
 729. Elmer Townsend.  
 731. John Sandys.  
 737. A. V. Newton.  
 739. A. D. Brown.  
 742. W. E. Newton.  
 743. A. V. Newton.  
 746. J. Inshaw and J. Parker.  
 750. A. V. Newton.  
 752. J. H. Johnson.  
 755. William Kestell.  
 756. G. F. Wilson and W. Walls.  
 766. James Higgin.  
 772. R. Brisco and P. S. Horsman.  
 775. F. G. B. Capouillet.  
 780. George Ross.  
 784. Jonathan Harlow.  
 785. S. R. Smith.  
 802. J. H. Johnson.  
 818. J. H. Johnson.  
 823. Thomas Whitehead.  
 828. Henry Kemp.  
 829. William Worby.  
 830. William Williams and T. E.  
 Williams.  
 836. William Wood.  
 837. William Wood.  
 849. J. J. Peile.  
 851. Uriah Scott.  
 858. Robert Whiteside.  
 859. William Coltman.  
 863. S. B. Parker.  
 870. William Ridgway.  
 876. P. A. Le Comte de Fontaine-  
 moreau.  
 887. C. C. Davis.  
 894. H. H. Gibbs.  
 905. R. A. Brooman.  
 910. Henry Brown.  
 923. Aimé Blavier.  
 934. Charles Hart.  
 938. James Combe.  
 940. T. W. Dodds.  
 941. Jonathan Davidson.  
 962. A. W. Gibson.

\* \* \* For the full titles of these Patents, the reader is referred to the corresponding numbers in the List of Grants of Provisional Protections.

CELESTIAL PHENOMENA FOR JULY, 1854.

D. H. M.		D. H. M.	
1	Clock before the ☉ 3m. 26s.	15	Ceres, R. A., 21h. 22m. dec. 27. 22. S.
—	☽ rises 9h. 40m. M.	—	Jupiter, R. A., 19h. 38m. dec. 21. 56. S.
—	☽ passes mer. 4h. 46m. A.	—	Saturn, R. A., 4h. 40m. dec. 20. 32. N.
—	☽ sets 11h. 35m. A.	—	Uranus, R. A., 2h. 55m. dec. 16. 19. N.
10 21	♃'s first sat. will im.	—	Mercury passes mer. 1h. 30m.
17 13	♄ in conj. with the ☽ diff. of dec. 4. 40. S.	—	Venus passes mer. 21h. 27m.
2 14 52	♃ in the descending node.	—	Mars passes mer. 4h. 41m.
18 30	♃ greatest elong. 26. 1. E.	—	Jupiter passes mer. 12h. 3m.
49 27	♃'s third sat. will im.	—	Saturn passes mer. 21h. 5m.
3	Vesta greatest hel. lat. N.	—	Uranus passes mer. 19h. 20m.
0 52	☽ in ☐ or first quarter	20	♃ oppo. ☉
5	Clock before the ☉ 4m. 11s.	22 17	♃ stationary.
—	☽ rises 2h. 45m. A.	16 22 6	Pallas oppo. ☉ intensity of light 0.310.
—	☽ passes mer. 7h. 46m. A.	17	Occul. 31, Arietis, im. 15h. 17m. em. 16h. 17m.
—	☽ sets 0h. 17m. M.	0 25	☽ in ☐ or last quarter.
—	Occul. 8 Librae, im. 9h. 26m. em. 9h. 51m.	10 54	♃'s first sat. will em.
9 0 16	♃'s first sat. will im.	18 6 26	♃ in conj. with the ☽ diff. of dec. 0. 54. N.
10 40	♃'s second sat. will im.	20	Clock before the ☉ 6m. 0s.
9 15 0	☽ in Perigee.	—	☽ rises 0h. 16m. M.
10	Clock before the ☉ 4m. 58s.	—	☽ passes mer. 8h. 21m. M.
—	☽ rises 9h. 14m. A.	—	☽ sets 4h. 41m. A.
—	☽ passes mer. Morn.	10 51	♃ in conj. with the ☽ diff. of dec. 2. 46. S.
—	☽ sets 3h. 22m. M.	21 9 6	♄ in conj. with the ☽ diff. of dec. 3. 29. S.
1 26	♃'s third sat. will im.	23	☽ in Apogee
2 16	♃ in conj. with the ☽ diff. of dec. 8. 45. N.	25	Clock before the ☉ 6m. 12a.
6 25	Ecliptic oppo. or ☉ full moon.	—	☽ rises 3h. 58m. M.
20 57	♄ in conj. with ♃ diff. of dec. 0. 15. S.	—	☽ passes mer. 0h. 29m. A.
11	Occul. 18, Ophiuchi, im. 9h. 18m. em. 10h. 19m.	—	☽ sets 8h. 45m. A.
12 18 46	♃ in Aphelion.	0 49	♃'s first sat. will em.
14	Occul. 33, Piscium, im. 10h. 45m. em. 11h. 4m.	3 16	Ecliptic conj. or ● new moon.
15	Clock before the ☉ 5m. 35s.	5 8	♃ in conj. with the ☽ diff. of dec. 9. 49. S.
—	☽ rises 11h. 10m. A.	27 7 52	♃'s second sat. will em.
—	☽ passes mer. 4h. 36m. M.	28 23 23	♃ in the descending node.
—	☽ sets 10h. 31m. M.	30	Clock before the ☉ 6m. 9s.
—	Mercury, R. A., 9h. 2m. dec. 13. 58. N.	—	☽ rises 9h. 56m. M.
—	Venus, R. A., 4h. 58m. dec. 20. 58. N.	—	Moon passes mer. 4h. 10m. A.
—	Mars, R. A., 12h. 13m. dec. 1. 11. S.	—	☽ sets 10h. 9m. A.
—	Vesta, R. A., 11h. 42m. dec. 8. 39. N.	6 19	♄ in conj. with the ☽ diff. of dec. 4. 5. S.
—	Juno, R. A., 11h. 52m. dec. 5. 45. N.	14 13	♃ in inf. conj. with the ☉
—	Pallas, R. A., 19h. 18m. dec. 20. 10. N.		

J. LEWTHWAITE, Rotherhithe.

THE  
LONDON JOURNAL,  
AND  
REPERTORY  
OF  
Arts, Sciences, and Manufactures.

---

CONJOINED SERIES.

---

No. CCLXXII.

---

---

RECENT PATENTS.

To JOHN ELCE, of the City of Manchester, machine-maker, for improvements in machinery for preparing and spinning cotton and other fibrous substances.—[Sealed 13th October, 1853.]

THIS invention consists, firstly, of an improved presser, applicable to the flyers of roving-frames, and other machines of the like nature; which presser is kept in contact with, and balanced, during the filling of the bobbin, by the action of a weight attached to, or forming part of, the presser-leg; secondly, in dispensing with the toothed segment and pinion, forming part of the copping-motion of the spinning machines, known as Roberts' self-acting mules, and in connecting the sector-shaft to the faller-shaft by a link and levers; whereby a uniform action is obtained, and the parts are capable of being more accurately adjusted than heretofore; and, lastly, in an improved arrangement of parts, also applicable to Roberts' self-acting mules, for starting the carriage and the drawing-rollers simultaneously.

In Plate IV., fig. 1, is an elevation of a roving-frame flyer, of the ordinary construction, with the improvements applied thereto; and fig. 2, is a plan view, in section, of the same. *a*, is the flyer; *b*, the spool, which is represented by dotted lines in fig. 1; and *c*, the presser, which is jointed to, and swivels partly round the hollow leg of the flyer, in the ordinary manner. *c*<sup>1</sup>, is a projection from the presser; into which is rivetted the wire *d*,—the upper part of which passes through the bearing *a*<sup>1</sup>, attached to the flyer-leg. The projection *c*<sup>1</sup>, and bearing *a*<sup>1</sup>, are used separately for some other

pressers. The wire *d*, is bent over above the bearing *a*<sup>1</sup>, and its lower end is made fast to the piece *e*, which is attached to the wire *d*, near to the presser: this outer portion of the wire, between the bearing *a*<sup>1</sup>, and the piece *e*, is marked *f*. When the flyer is revolving, the centrifugal action of the part marked *f*, keeps the presser in contact with the bobbin; and the rovings are wound at or nearly a uniform pressure, from the commencement to the completion of a bobbin. The equilibrium of the spindle is maintained, and, consequently, the injurious effects of vibration are avoided, owing to the relative position of the presser and part marked *f*, and to the presser itself moving round the flyer-leg; whereas, the upper part of the wire *d*, moves in the bearing *a*<sup>1</sup>.

Figs. 3, and 4, represent a modification of the improvements in pressers. In these views the wire *d*, is bent above the bearing *a*<sup>1</sup>, and to it is attached the weight *g*, the action of which is similar to that of the part *f*, described in reference to figs. 1, and 2.

Figs. 5, and 6, represent another modification of this part of the invention. In this instance the presser is connected to the flat bar *h*; the upper end of which is supported by and swivels in the bearing *a*<sup>1</sup>. This flat bar *h*, is heavier at its upper than at its lower end; but it may be of equal dimensions throughout. The action of this bar on the presser is similar to that of the part *f*, described in reference to figs. 1, and 2. In the three flyers above described, the bearing *a*<sup>1</sup>, is made with shoulders, to prevent the presser flying back when the machine is stopped.

Fig. 7, is a side elevation of a self-acting mule, shewing the improvements applied thereto; and fig. 8, is a plan of the same. In these views *i*, is the framing; *j*, the front drawing-roller; *k*, the cam-shaft; *l*, the back-shaft; *m*, the carriage; *n*, the faller-shaft; *o*, the counter faller-shaft; and *p*, the sector-shaft; all of which parts are made in the usual manner. To the faller-shaft *n*, is fixed a small lever *n*<sup>1</sup>; to which is jointed one end of the link *q*: the other end of this link is jointed to the lever *p*<sup>1</sup>, which is cast, or otherwise fixed, to the smooth segment *p*<sup>2</sup>. The link *q*, and the levers *n*<sup>1</sup>, and *p*<sup>1</sup>, form the connection between the faller-shaft and sector-shaft, and are used in lieu of the toothed segment and pinion usually employed for the same purpose. By this means the injurious effect of the play between the teeth is avoided, and the relative position of the fallers can be adjusted with great facility, by loosening the set-screw in the boss of the lever *n*<sup>1</sup>, and tightening it again when the lever *n*<sup>1</sup>, has been set. The

other parts of the coping-motion are not shewn, as they are similar to those in general use.

The last part of this invention consists in an improved combination of parts for effecting the simultaneous starting of the carriage and drawing rollers. In Roberts' self-acting mules it is customary to have a catch-box on the back shaft, and another catch-box on the front drawing roller; and unless both these catch-boxes are thrown into gear at the same time, the starting of the drawing rollers and carriage is not simultaneous. In order to ensure the starting of the carriage and the drawing rollers at the same time, and to simplify the head-stock, both the catch-boxes above referred to are dispensed with, and the following pieces are substituted:—Upon the front drawing roller  $j$ , is keyed a ratchet wheel  $j^1$ : this ratchet wheel is placed within the spur wheel  $j^2$ , in which are fixed studs for the clicks  $j^3$ . The wheel  $j^2$ , is cast or otherwise fixed to the mitre pinion  $j^4$ , both of which are loose on the front drawing roller. The mitre pinion  $j^4$ , gears into the pinion  $r$ , the back of which is furnished with catches. The pinion  $r$ , is loose on the shaft  $r^1$ , which is supported in bearings in the framing  $i$ .  $r^2$ , is the sliding part of the catch-box, which fits on a key fixed to the shaft  $r^1$ , in the usual manner of making catch-boxes.  $s$ , is a lever, from which projects a fork for moving the catch-box  $r^2$ : this lever is supported on the stud  $s^1$ , and is acted upon by the cam  $k^1$ , on the cam-shaft  $k$ . To the end of the shaft  $r^1$ , is fixed a spur pinion  $r^3$ , which is driven from the main driving shaft  $t$ , by the pinion  $t^1$ , and carriers  $t^2$ , and  $t^3$ . The back shaft  $l$ , is driven by the wheel  $j^2$ , in the following manner:—The wheel  $j^2$ , gives motion to the carrier-pinion  $u$ , gearing in the change wheel  $u^1$ ; and to this wheel is fixed a pinion  $u^2$ , which gears into the wheel  $l^1$ , on the back shaft  $l$ , on which is fixed the drawing-out drum  $l^2$ , in the usual manner. The speed of the shaft  $l$ , can be varied by removing the wheel  $u^1$ , and substituting another with more or less teeth in it. The carriage is taken out by the cord  $l^3$ , which is wound on the drum  $l^2$ , and attached to the carriage in the ordinary manner, as shewn in fig. 7. The mode of operation is as follows:—When the carriage is going out, and the drawing rollers are in motion, the catch-box  $r^2$ , is in gear with the catches on the back of the bevil pinion  $r$ ; the requisite motion being given to the shaft  $r^1$ , from the main driving shaft  $t$ , as above described. The front drawing roller is carried round by the clicks  $j^3$ , acting on the ratchet wheel  $j^1$ . As soon as the carriage arrives at the end of its stretch, the cam-shaft performs part of a revolution in the usual manner;



thereby causing the lever  $s$ , to draw the catch-box  $r^2$ , out of gear, and stop the drawing rollers and back shaft. When the carriage is going in, the back shaft is carried round in the contrary direction to that in which it revolves when the carriage is going out, as shewn by the dotted arrow in fig. 7; and the wheel  $l^1$ , then imparts motion to the wheel  $j^2$ , also in the reverse direction to that of the drawing rollers. The clicks  $j^3$ , consequently pass over the teeth in the ratchet-wheel  $j^1$ , until the carriage is home. When the carriage is ready to commence another stretch, the cam  $k^1$ , brings the catch-box  $r^2$ , again into gear, and the operation is repeated as before. The other parts of the mule that are not shewn in the drawing, are similar to those in general use; and as they are well understood by persons conversant with spinning, they do not require to be particularly referred to.

The patentee claims, Firstly,—the improved balanced pressers hereinbefore shewn and described. Secondly,—the link  $q$ , and levers  $n^1$ , and  $p^1$ , shewn in figs. 7 and 8, when used as substitutes for the pinion and toothed segment usually employed for connecting the faller shaft and sector shaft of Roberts' self-acting mules. And, Lastly,—the improved combination of parts for starting simultaneously the carriage and drawing rollers of the machines for spinning, known as Roberts' self-acting mules.

---

To JOHN HENRY JOHNSON, of *Lincoln's-inn-fields, Gent.*, for *improvements in steam-engines,—being a communication.*  
—[Sealed 18th March, 1853.]

THIS invention relates to a peculiar arrangement of the cranks of marine or other engines, whereby the great lateral strain upon the bearings of the main shaft, as well as the injurious vibratory or tremulous movement of the machinery, is obviated. This is effected by placing the cranks on the main shaft diametrically opposite each other, and thus neutralizing the strain or lateral pressure of the piston or connecting-rods against the main shaft.

In Plate III., fig. 1, represents a transverse section of a vessel through the propeller-shaft, shewing the engines in side elevation; and fig. 2, is a corresponding plan of the same, shewing the general arrangement of the two pairs of engines. The crank or propeller-shaft  $a$ , is situated between the cylinders  $c$ ,  $c^1$ , and is formed into three successive cranks; all of which are in the same plane, but arranged in such a

manner that the middle one  $d$ , is diametrically opposite to the other two  $e, e$ . The centre crank is connected with the head of the piston-rod  $b$ , of one of the cylinders, whilst the outside cranks  $e, e$ , are connected with the opposite piston-rods  $b^1, b^1$ , which are fitted into the piston of the second cylinder. The valve-gearing may be worked by any of the well known methods adopted in marine engines of this class, and so arranged that the pistons shall move in precisely opposite directions. Supposing the crank-shaft to be revolving in the direction indicated by the arrow in fig. 1, the rod  $b$ , of the right-hand cylinder will advance in the direction indicated on the drawing, at the same time that the two other piston-rods  $b^1, b^1$ , of the left-hand cylinder traverse in the contrary direction. Thus the crank-pin  $a^*$ , is pushed from right to left, while the other two  $e, e$ , will be propelled in the contrary direction, or from left to right. Thus, when the latter approach the extremity of their stroke, they no longer produce those injurious reactionary shocks hereinbefore mentioned; since, whatever may be the weight or speed of the cranks, the reaction will be entirely neutralized by the opposite one; as, at the same time that one piston approaches the top of one cylinder, the other piston approaches the bottom of the opposite cylinder. During the return-stroke, the pistons assist each other, until they arrive at the opposite end of their traverse,—all reactionary force being obviated. It will thus be seen that an equilibrium of pressure is exerted against the main bearings of the shaft  $a$ , since the pressure on each side is the same throughout its entire revolution. This effect is produced during the entire traverse of the piston, as they constantly occupy the same relative positions in each of their respective cylinders, but in different directions. In thus obtaining an equal pressure on each side of the main shaft, it follows, that its bearings will be much less strained, and, consequently, that the friction will be greatly reduced; thereby effecting a saving in lubricating material, and obviating the shaking of the frame-work, so injurious to its stability. The number of revolutions may also be greatly increased, without much inconvenience, as a greater regularity is obtained in the working of the engines. In the construction of engines of four cylinders, the two shafts  $a, a$ , if of large dimensions, may be coupled between the two pairs of cylinders. To effect the working of the air-pumps  $g, g^1$ , two cranks  $f, f^1$ , are formed on the main shaft,—care being taken that they be in diametrically opposite positions, as shewn in plan view at fig. 2. Thus the pressure of these two pistons is also

neutralized,—tending, as before described, to reduce the friction and straining of the main bearings. Although the air-pumps  $g, g^1$ , are represented as placed between the two engines, yet they may, with equal convenience and facility, be placed outside the engines; which, in such case, would be brought nearer together, and would probably occupy less space. It will be obvious to the practical engineer, that this arrangement of cranks is equally applicable and serviceable to engines with either vertical or horizontal cylinders,—such cylinders being either fixed or oscillating; since the use of connecting-rods and guides does not interfere, in any way, with the peculiar arrangement of cranks hereinbefore described. When four cylinders are employed, as shewn in the drawing, the cranks of one pair of cylinders are placed at right angles with the cranks of the second pair; thereby producing a perfect regularity of movement with a great velocity of working, whether the engine be required for the screw propeller or for manufacturing purposes. Should the engine be a single one, or of two cylinders only, they may be made of equal diameter,—receiving, each of them, their steam direct from the boiler; or they may be arranged as in the Woolff engine; namely, one of the cylinders only (the smaller one) receiving its steam direct; giving it afterwards to the larger cylinder, after actuating the piston of the first one. The cranks may be so arranged as to form a certain angle between them, more or less obtuse, in place of being diametrically opposite each other.

The patentee claims the system or mode of constructing crank-shafts with the cranks in the same plane, or nearly so, for the purposes hereinbefore described.

---

*To EDWARD WALMSLEY, of Heaton Norris, in the county of Lancaster, spinner, and JOHN HOLMES, of Manchester, engineer, for improvements in, and applicable to steam-engines.—[Sealed 16th June, 1853.]*

THIS invention consists in certain improved combinations of machinery for regulating the opening of the slide or other valves of steam-engines, according to the power required to be exerted by the steam-engine; and, secondly, in machinery for connecting and disconnecting the governor and the valve-rod.

In Plate III., fig. 1, is a side elevation of a steam-engine, shewing a mode of applying these improvements; and fig. 2,

is a front elevation of the same. *a*, is the framing of a steam-engine; *b*, the cylinder; *c*, the slide-valve; *d*, the connecting-rod; *e*, the crank-shaft; and *f*, the governor; all of which may be made in the usual manner. The rod *g*, which is connected to the sliding-bush *f*<sup>1</sup>, of the governor, is jointed below to the lever *g*<sup>1</sup>, which is fixed to the same shaft as the lever *h*: this lever is connected to the rod *c*<sup>1</sup>, of the slide-valve *c*, by a link *h*<sup>1</sup>. The upper end of the rod *c*<sup>1</sup>, is hinged to a block *i*, fitting in the slot-lever *i*<sup>1</sup>, as seen in fig. 2. To the crank-shaft *e*, is fitted the excentric *e*<sup>1</sup>, which gives a uniform vibrating motion to the slot-lever *i*<sup>1</sup>, by the connecting-link *e*<sup>2</sup>. The uniform motion of the slot-lever *i*<sup>1</sup>, is made to impart a varying traverse motion to the slide-valve *c*, by altering the position of the sliding-block *i*, in the slot-lever *i*<sup>1</sup>; and this is accomplished by the governor in the following manner:—When the engine is at work with its usual load, and at its regular speed, the block *i*, is kept, by the governor-balls, at about the centre of the slot in the lever *i*<sup>1</sup>; when in this position the traverse of the slide-valve *c*, is about equal to the throw of the excentric *e*<sup>1</sup>; but, as soon as the load of the engine is increased, and more steam is required to drive it, the governor-balls, in collapsing, push down the bush *f*<sup>1</sup>, and cause the rod *g*, levers *g*<sup>1</sup>, and *h*, to push the upper end of the rod *c*<sup>1</sup>, and the sliding-block *i*, further from the fulcrum *i*<sup>2</sup>, of the slot-lever *i*<sup>1</sup>, or into the position shewn in fig. 2. By this means the uniform vibrating motion of the lever *i*<sup>1</sup>, is made to increase the traverse of the slide-valve *c*; thereby causing the steam-ports to remain longer open, and admit more steam to the cylinder *b*. If, on the other hand, the load of the engine is diminished, the increased speed of the engine causes the governor-balls to expand; thereby raising the rod *g*, and drawing the sliding-block *i*, towards the fulcrum *i*<sup>2</sup>, of the slot-lever *i*<sup>1</sup>; consequently diminishing the traverse of the slide-valve *c*, so as to admit less steam to the cylinder, and reduce the speed of the engine. If it is found requisite to stop the engine, without shutting off the steam, the attendant, by acting on the lever *h*, can draw the sliding-block *i*, so as to make the joint-pin of the rod *c*<sup>1</sup>, coincide with the fulcrum *i*<sup>2</sup>, of the slot-lever *i*<sup>1</sup>: by this means it is evident that the slide-valve *c*, will be stopped, and no steam can enter the cylinder.

Another combination of parts, for effecting the same object, is represented at fig. 3, which is an elevation of a steam-engine, to which these improvements are applied. *l*, is the cylinder; *m*, the valve-rods; *m*<sup>1</sup>, and *m*<sup>2</sup>, the valve-levers;

$n$ , the crank-shaft; and  $o$ , the governor; all of which are made in the usual manner. Upon the crank-shaft is fixed an excentric  $n^1$ ,—the connecting-rod from which gives a uniform vibrating motion to the slot-lever  $p$ . This lever is furnished with a sliding-block  $p^1$ , to which is jointed the balanced bar  $q$ ,—a notch in which fits on a stud projecting from the lower arm of the lever  $m^2$ . The bar  $q$ , is connected to the sliding-bush  $o^1$ , of the governor, by the rod  $q^1$ , lever  $q^2$ , and rod  $q^3$ , as shewn in fig. 3. When the speed of the engine is about equal to the power required, the governor-balls hold the sliding-block  $p^1$ , near the centre of the slot-lever  $p$ ; but, when more or less steam is required, in order to increase or diminish the speed of the engine, the governor-balls raise or lower the sliding-block  $p^1$ , by the rods  $q^1$ , and  $q^3$ , and lever  $q^2$ ; thereby increasing or diminishing the action of the slide-valves, as before described in reference to figs. 1, and 2.

Fig. 4, is an elevation of an ordinary beam-engine, to which another modification of these improvements is applied. In this combination of parts the rod  $q^1$ , instead of acting upon the balance-bar, which gives motion to the elbow-lever of the slide-valves, is connected below to a rack-bar  $r$ , which gives motion to a pinion fixed on the same shaft as another pinion  $r^2$ ; which latter gears into a segment  $s$ , forming part of a slide working in the grooved plate  $s^1$ . The slot-lever  $s^2$ , to which the connecting link of the excentric  $n^1$ , is jointed, fits on a fulcrum-stud fixed to the segment  $s$ ; and in the slot-lever  $s^2$ , is a sliding-block  $t$ , to which is jointed the rod  $t^1$ , by which the valve-lever  $m^2$ , is put in motion. The upper end of the rod  $t^1$ , is guided by the rollers  $t^2$ , mounted on fixed studs. The drawing shews the various parts in the positions they assume when not much steam is required: the link from the excentric  $n^1$ , being jointed to the slot-lever  $s^2$ , above the sliding-block  $t$ , imparts a shorter traverse to the slide-valves than the throw of the excentric; but, as soon as the speed of the engine begins to decrease, the governor-balls, in collapsing, move the rack-bar  $r$ , upwards; thereby turning the pinion  $r^2$ , partly round in the direction of the arrow, and moving the segment  $s$ , and slot-lever  $s^2$ , downwards; thereby bringing the joint of the connecting-link from the excentric  $n^1$ , towards the centre of the sliding-block  $t$ , and increasing the traverse of the slide-valves. The contrary action takes place when the governor-balls expand, owing to the speed of the engine being too great. When it is found desirable to disconnect the governor from the sliding-blocks hereinbefore referred to, it is proposed to work the

sliding-block to and fro in the slot-lever, by means of a screw passing through a nut, connected by a link to the sliding-block. At the end of this screw is a bevil-wheel, gearing into two bevil-pinions, furnished with catches, fitting loosely on a shaft to which motion is given from the governor, spindle, or other convenient part of the engine. Between the two bevil-pinions is a sliding catch-box, which is brought into action with the catches, on either of the bevil-pinions, when required. The rod from the governor acts on a lever, in connection with the sliding catch-box; and when the engine is working at its proper speed, both the bevil-pinions are at rest; consequently the sliding-block remains in the same position in the slot-lever: but, when more or less traverse is required to be given to the steam-valve, the sliding catch-box is brought into gear with either one or the other of the bevil-pinions; and the screw, by moving either in one direction or the other, draws the sliding-block nearer to, or further from the fulcrum of the slot-lever; thereby producing the desired effect on the slide-valve. Instead of the screw and nut, the sliding-block may be moved to and fro by means of a rack and pinion, or other mechanical agents. The slide or other valve may also be made to admit more or less steam to the cylinder of the engine by means of a slot made in the face of a disc or wheel. When this mode of working the valve is adopted, the valve-rod must be jointed, at one end, to a stud fitting in the slot, and, at the other end, to the valve-spindle. In this case it is preferable to give motion to the disc in which the slot is made, by a wheel on the crank-shaft. The stud in the disc is made long enough to enter into a scroll-groove, fixed on a shaft whose centre coincides with the centre of the disc. As long as the engine is working at its proper speed, this shaft, with the scroll, revolves at the same speed as the engine; consequently the stud, in the slot of the disc, remains at a uniform distance from the centre of the disc, and imparts a regular traverse motion to the steam-valve; but, if the engine increases its speed, the governor-balls, in expanding, throw into gear a pair of wheels acting on the scroll-shaft, which reduces the speed of the scroll; thereby drawing the stud in the disc nearer to its centre, and reducing the traverse of the valve. As soon as the engine has regained its proper speed, the governor-balls, in assuming their proper position, disconnect the wheels which had reduced the speed of the scroll-shaft, and the engine continues its work as before. When the contrary action takes place, and the speed of the engine is too slow, the governor-balls,

in collapsing, throw into gear another pair of wheels, by which the speed of the scroll-shaft is increased: the action of which increases the distance of the stud from the centre of the disc; thereby increasing the traverse of the slide-valve, and admitting more steam to the cylinder.

The patentees remark, that although they have described their improvements in connection with the ordinary ball-governor, they do not limit themselves thereto, as several other governors are known and in use, which are also capable of producing the same effects. They claim, First,—the application of the slot-levers marked  $s^1$ ,  $p$ , and  $s^2$ , and parts acting in combination therewith, for regulating the speed of steam-engines, as shewn and described. Secondly,—the combination of machinery described, for connecting and disconnecting the governor and the valve-rod. And, Lastly,—the moving the valve-rod stud in a slotted disc, for regulating the speed of steam-engines, as described.

---

*To JOHN GRIFFITHS, of Stepaside, Saunderfoot, near Tenby, in the county of Pembroke, South Wales, engineer, for certain improvements in steam-engines.*—[Sealed 2nd August, 1853.]

THIS invention consists in conveying a portion of the discharged steam of high-pressure engines into a receiver, to be again used, and the remainder to the condenser; whereby a better vacuum is obtained, and the steam is more advantageously applied than heretofore. In Plate III., fig. 1, is a sectional elevation of part of a steam-engine, to which the requisite parts are attached for illustrating one mode of applying these improvements; and fig. 2, is a side view of the same. In fig. 1,  $a$ , is part of the cylinder of a high-pressure engine; and  $b$ , is the branch leading to the disjunction-valve  $c$ . This valve  $c$ , closes the opening of the pipe  $e$ , by which the steam is conveyed to the condenser; and the valve  $d$ , which is shewn open, allows the steam to escape through the pipe  $f$ , to a receiver, to be again used in another cylinder, as will be explained hereafter, or into a pipe to be used for heating or other purposes. In fig. 2,  $g$ , is the crank-shaft of the engine, and  $g^1$ , an excentric for working the valve  $c$ , by means of the levers  $g^2$ , and  $g^3$ . The valve  $d$ , is opened by the off-steam, when let out of the cylinder by slide or other valves.

The mode of operation is as follows:—When the piston of the cylinder  $a$ , is descending, part of the steam under the

piston is allowed to escape through the valve *d*, and pipe *f*; and when the requisite quantity of steam has been thus disposed of, the valve *c*, is opened by the excentric *g*<sup>1</sup>, to admit the remainder to the condenser: the valve *d*, is then instantly closed, owing to the steam in the off-pipe *f*, acting on the top of the valve.

Fig. 3, is a plan of a pumping-engine to which these improvements are applied; and fig. 4, represents a sectional elevation of the valves and other parts for working the same. *h*, is a boiler of the ordinary construction; and *h*<sup>1</sup>, the pipes for conveying the steam to the cylinder *i*. *j*, is the receiver into which part of the steam from the cylinder *i*, is conveyed before the remaining portion is let into the condenser. This receiver is placed near the boiler, and it is kept warm by the flue which is carried under it previous to entering the chimney *k*, seen in fig. 3. The high-pressure steam, on leaving the boiler *h*, passes through the valve *l*, which is shewn open, and thence, through the steam-port *m*, to the upper end of the cylinder: and at the same time that the high-pressure steam is entering above the piston, the valve *n*, is open, to allow the steam from below the piston to enter the condenser. When the piston is near the bottom of its stroke, the valves *n*, and *l*, are closed. As soon as the piston is at the bottom of its stroke, the valves *p*, and *r*, are opened, to allow the steam above the piston to escape into the receiver; and the valve *q*, is opened, to admit the steam from the receiver to the underside of the piston. As soon as the steam above the piston has expanded to the pressure of the steam in the receiver, the valve *o*, is opened, to admit the remainder to the condenser: the valve *r*, then closes, owing to the pressure of the steam in the receiver acting upon its under surface. By this mode of working, the pressure of the atmosphere is made available during the descent and ascent of the piston; whereas the steam from the boiler is only applied at one side of the piston. *z*, is a cock for letting steam into the receiver before the engine is started. When this mode of working is applied to an engine for communicating rotary motion, it will be requisite to have a counter-balance on the fly-wheel; as the power is greater at that part of the stroke during which the steam from the boiler is acting, than at that part acting by the steam from the receiver.

The patentee next proceeds to describe the application of his improvements to steam-engines working with two cylinders. Fig. 5, is a vertical section of a high-pressure cylinder and valves in connection therewith. The low-pressure cylinder is



not shewn in the drawing, but it may be placed in any convenient position so as to act on the other end of the beam, as is customary in working compound engines of the ordinary construction, or on a separate beam, as in marine engines. Fig. 6, is another vertical section taken from the reverse side of the engine. Fig. 7, is a plan in section, and fig. 8, another elevation, partly in section, of the valves. *s*, is the high-pressure cylinder; *l*, the steam-chest; *u*, the slide-valve; *v*, the disjunction-valve; *x*, the valve for supplying the low-pressure cylinder, the area of which should be about double the area of the high-pressure cylinder; and *w*, the pipe under the valve *v*, for conveying the steam to the condenser. The valves *v*, and *x*, may be worked as shewn in fig. 2, or in any other convenient manner. When the high-pressure steam has acted on the piston in the cylinder *s*, part of it is let off through the valve *x*, into the receiver, from whence it is taken to act on the piston in the low-pressure cylinder; and the remainder is let into the condenser through the pipe *w*. The whole of the steam from the low-pressure cylinder is admitted to the condenser. By this mode of working, both the cylinders act like independent condensing engines, although only one supply of steam from the boiler is required.

Another improvement consists in working high-pressure engines without a condenser. In this case two cylinders are required; the first cylinder being supplied with steam from the boiler at, for instance, sixty pounds per square inch pressure (atmosphere not included). A portion of this steam, after acting on the piston, is let off into a receiver similar to *j*, in fig. 4, at, for instance, twenty-two pounds per square inch pressure,—the remaining portion of the steam being blown off into the atmosphere. The second cylinder is supplied with steam from the receiver, which, after doing its duty, is blown off into the atmosphere. Another modification of this part of the invention is effected by using only one cylinder, and admitting high-pressure steam for the down-stroke, and steam from the receiver for the up-stroke, or *vice versa*.

The patentee claims the application of the receiver *j*, for the purposes hereinbefore described; also applying a portion of the off-steam of high-pressure engines for heating or other purposes, and condensing the remainder as described with reference to figs. 1 and 2.

---

To WILLIAM HUNTLEY, of *Ruswarp, near Whitby, in the county of York, engineer, for improvements in engines worked by steam, air, or fluids.*—[Sealed 23rd July, 1853.]

THIS invention consists in the construction of the mechanism connected with the valves of engines for the purposes of varying the extent of the opening of the port for the admission of steam, air, or fluids, into the cylinder at the termination or commencement of the stroke of the piston (technically termed "lead" or "advance"); cutting off the steam, air, or fluids at that part of the stroke requisite for the work the engine has to perform; preventing the admission of steam, air, or fluids to the cylinders, and the ingress of air through the exhaust-ports; also admitting steam, air, or fluids, into the cylinders, to stop the engine, and to prevent it from running in a contrary direction; or regulating the working slides or valves by the engine-governor; cutting off the steam, air, or fluids at any part of the stroke necessary for the regularity of the speed of the engine,—the steam, air, or fluids being, in all cases when admitted to the cylinders, of the same elasticity or pressure as that in the boiler or reservoir, excepting when gentle retarding is required.

In Plate III., fig. 1, is a side view, partly in section, of part of a horizontal cylinder engine; and figs. 2, 3, 4, 5, 6, are detail views. To each cylinder of the engine, on the main shaft *A*, there is a valve-regulator *B*; which valve-regulator is a body of circular character fitted with slide bearings *C*, (see figs. 2, and 3,) which cause the regulator to slide or work on guides or bars *E, E*, fitted on the same shaft; and there is fixed on this shaft an excentric *G*. (see fig. 1.) The regulator has two cross-bars or guides *D*, (see figs. 2, and 3,) on the opposite side thereof, to be acted on by the blocks or slides *H*, (see fig. 1,) on the straps *G\**, of the excentric *G*. The guides or bars *C*, and *D*, respectively, are equidistant from the centre of the regulator *B*. A rod *I*, (see fig. 1,) for transmitting motion from the regulator, attached thereto with straps in a similar manner to a common excentric rod, transmits motion from the regulator to the rectifying-lever *K*, which is a double lever with a curved groove from end to end of a radius equal in length to the slide or valve-rod *L*; which slide or valve-rod is fitted with a block *M*, at one end, to move freely in the curved groove of the rectifying-lever *K*. The other end of the rod *L*, is connected to the slide or valve-spindle *N*, to give motion to the slides or valves of the cylinder *O*. In en-

gines not required to retrograde, the rectifying double lever may be superseded by a single lever.

Fig 7, shews the invention applied to an engine with a vertical cylinder, and the regulator worked by the governor of the engine. Figs. 8, to 12, are detail views. The principal points of difference between this arrangement and the one previously described is, that, instead of the regulator and the parts belonging thereto being placed on the main shaft *A*, it is here shewn placed on a second shaft (see *k*, figs. 7, and 12); which second shaft carries the toothed wheel *l*, gearing with, and receiving motion from a corresponding wheel *m*, fixed on the main shaft *A*: this toothed wheel *l*, works the excentric,—being connected therewith in manner shewn in section at fig. 12. The second shaft *k*, has a sector *n*, affixed to it, which gears with a thread or worm *o*, on the shaft *o\**, which is driven by bevelled gearing from the governor-spindle in the ordinary manner. The governor is in all respects similar to governors in ordinary use; and the spindle thereof is driven from the main shaft *A*, by the gearing which gives motion to the shaft *p*. It will be seen that there is a loose tooth *q*, jointed to the sector *n*, and provided with a spring or weight, for the purposes hereafter set forth.

To work an engine of the arrangement shewn at fig. 1, with this invention applied thereto:—Supposing the engine to be a locomotive, the position shewn by the drawing is that of the best starting point: the regulator-lever *R\**, being at 1, and the slide-rod *L*, being at 1, on the rectifying-lever *K*, they will remain so till the engine is set in motion by the steam being admitted to the cylinder at the commencement of the stroke of the piston, and steam-port full open, at about 6 per cent. of the stroke of the piston, and cut off at about 94 per cent. of the stroke of the piston. In order to adjust the slides or valves so as to give more lead or advance without altering the travel of the slides or valves, the regulator-lever *R\**, is shifted from the dotted line 1 to 2, and the slide-rod *L*, from the dotted line 1 to 2, on the rectifying-lever *K*; and should more lead or advance be required, both levers are to be consecutively moved from 2 to 3, and so on to 6. At this point the steam is admitted to the cylinder at about 95 per cent. of the stroke of the piston; and the steam-port nearly full open at the commencement of the stroke of the piston,—cutting off the steam at about 84 per cent. of the stroke, which gives about the greatest degree of lead or advance practicable. In order to have more expansion, let the regulator-lever *R\**, be removed from the dotted line 6 to 8,—the

slide or valve-rod *L*, remaining at *s*, on the rectifying-lever *κ*,—the steam-port will begin to open at about 90 per cent. of the stroke of the piston, and will be nearly full open at the commencement of the stroke of the piston,—cutting off the steam at about 70 per cent. of the stroke of the piston. Now let the regulator-lever *R\**, be removed from *s* to *10*, and the lead or advance will be about one-eighth of an inch, and will remain nearly so until cut off at about 15 or 20 per cent. of the stroke of the piston,—thus giving about the greatest degree of expansion practicable: then remove the regulator-lever *R\**, to *L\**; the steam will thus be shut off from both ends of the cylinder or cylinders: or, what will be equivalent, remove the slide or valve-rod *L*, to the centre of the rectifying-lever *κ*,—the slides or valves always acting as a shut-off valve but with more safety, to prevent the engine from getting into motion: and this also prevents the ingress of air and deleterious matter into the cylinder through the exhaust-port. To make the engine move in the contrary direction, the regulator-lever *R\**, and the slide or valve-rod *L*, will both have to be managed in a similar way on the dotted lines *a, b, c, to j*, beginning with *a*, in the same manner as 1, 2, 3, to 10. Handles or hand-gear are to be connected to the regulator-lever *R\**, at the point where 1, is placed, and also on the slide-rod *L*.

For stopping or holding the engine:—Supposing the regulator-lever *R\**, to be at any of the angles 1, 2, 3, and the valve-rod *L*, at any of the angles 1, 2, 3, on the rectifying-lever *κ*, let the regulator-lever *R\**, be brought to about 10, and the valve-rod *L*, removed to *f*, on the rectifying-lever *κ*, the steam will be admitted into the cylinder before the termination of the stroke, when the piston and steam will go in the same direction for about 5 per cent. of the stroke of the piston,—charging the cylinder with steam to act in opposition to the piston for about 80 per cent. of the stroke of the piston: thus producing holding-power more than equal to the propelling power of the engine. To stop the engine when going in the contrary direction, make the contrary angles with the regulator-lever and valve-rod. Whatever number of cylinders an engine may have, it requires the same number of excentrics and regulators, except when two or more cylinders are acting simultaneously; then only one excentric and regulator are required, either for going direct or to retrograde.

With regard to fig. 7, the effects produced by the hand-gearing may be superseded by the action of the governor, by the arrangement shewn; although hand-gearing may be applied to the same arrangement: and this governor arrange-

ment may be applied to the arrangement shewn at fig. 1; the operation of the governor being this—that when the sector *n*, is driven by the thread or worm *o*, then it works the sector on until it comes to the loose tooth *q*, where it puts itself out of gear (the whole power being then applied), and remains so, until the contrary motion is communicated to the shaft *o'*, by the rising of the governor, when the worm is brought into gear by the loose tooth, giving space for the thread to enter and gear with the sector; which, it is obvious, operates to adjust the slides for the regularity of the speed of the engine.

The patentee claims, First,—the use and adaptation of the slide or valve-regulator and the rectifying-lever. Second,—the use and adaptation of the governor of the engine to regulate the slides or valves, as set forth. Third,—the application of steam, air, or fluids, to the cylinder or cylinders of engines, to act on the piston or pistons, to retard, stop, and hold the engine or engines, as before described. And, Fourth,—preventing the ingress of air and any deleterious matter into the cylinder or cylinders through the exhaust-ports, when the engine is in motion and the steam shut off, as before described.

---

*To SAMUEL ADAMS, of West Bromwich, in the county of Stafford, manufacturer, for a new or improved apparatus for regulating the supply of water to steam and other boilers; applicable also to regulating the supply of liquids to vessels and reservoirs in general.*—[Sealed 12th Aug. 1853.]

THIS invention consists in the use of a stop-cock in connection with a force-pump; such stop-cock being so connected with a float in the boiler or other vessel as to permit of the escape of the water or other liquid raised by the force-pump when the liquid in the boiler or vessel is sufficiently high.

In Plate IV., fig. 1, represents these improvements in vertical section, as applied to a steam-boiler. *a*, is the force-pump, by which a stream of water is raised from the reservoir *b*, through the pipe *c*, and valve *d*, and forced through the valve *e*, and along the pipe *f*; *g*, is a valve, which is situated at or near the point at which the pipe *f*, divides into the two pipes *h*, *i*. It may, however, be situated in any other convenient part of the pipe *h*. The pipe *h*, terminates or opens near the bottom of the boiler *k*, in the ordinary manner; and the pipe *i*, is terminated by a stop-cock *l*, which opens into the box *m*. *n*, is a pipe, which returns any liquid emptied into the box *m*, to the reservoir *b*. The arm *o*, of the stop-cock *l*, is jointed at one end to the

lever *p*; and a float *q*, in the boiler, is jointed to the other end of the lever *p*. As the pump *a*, is worked by the excentric *r*, a stream of water is raised from the reservoir *b*, and is forced along the pipe *f*, and, passing through the valve *g*, along the pipe *h*, enters the boiler *k*. When, however, the level of the water in the boiler *k*, rises to the required height, the float *q*, acting through the lever *p*, causes the arm *o*, of the stop-cock *l*, to be depressed, and the stop-cock partially opened; and a portion of the water, which otherwise would have been forced along the pipe *h*, into the boiler *k*, passes out at the stop-cock *l*, and returns by the pipe *n*, to the reservoir *b*. Thus, while the water raised and forced by the pump *a*, is the same in quantity for each revolution of the excentric *r*, the quantity of the water which enters the boiler is altogether determined by the stop-cock *l*, acted upon by the float *q*. Instead of a stop-cock of the ordinary construction, that is to say, having a conical plug, a stop-cock of the construction represented partly in section in fig. 2, is preferred; such stop-cock consisting of a cylindrical plug *s*, working on an axis *t*. In a stop-cock of this construction, the tendency of the plug to stick or set, which is common in stop-cocks of the ordinary construction, does not exist. In supplying steam-boilers from a stream or well, a rose *v*, is placed at the bottom of the supply-pipe, for the purpose of preventing solid matters from rising up the pipe *c*.

The patentee claims the construction of an apparatus for regulating the supply of water to steam and other boilers, and of liquids to vessels and reservoirs generally, by causing the stream of liquid to pass through a pipe furnished with a stop-cock; which said stop-cock is so connected with a float in the boiler or vessel, that, when the liquid in the said boiler or vessel is sufficiently high, the said stop-cock is opened, and the liquid permitted to escape, instead of being forced into the boiler or other vessel.

---

*To WALTER WILLIAMS, jun., of West Bromwich, in the county of Stafford, iron master, for improvements in machinery for cutting or shearing iron and other metals.—*  
[Sealed 31st January, 1853.]

**THIS** invention consists in a peculiar arrangement and combination of mechanical parts, forming in the whole a machine applicable to cutting plates of iron or other metal,—such, for instance, as boiler-plates.

In Plate IV., fig. 1, is a front elevation of the machine; fig. 2, an elevation of one end; and fig. 3, an elevation of the opposite end.  $x$ , is the cast iron bed-plate, to which are secured the standards or holsters  $p$ , the carriage  $v$ , and the general framework of the machine. On the shaft  $a$ , (connected by drum, crank, or any suitable means with the steam-engine), is hung the screw-wheel  $b$ , working into a toothed wheel  $c$ , revolving on an axle suspended in proper bearings at  $b^1$ , from the under side of the bed-plate. On this axle is a double throw-crank  $d$ ,—to the arms of which are attached pins  $d^1$ , working in the guides  $e$ , on the ends of the blades  $f$ . These blades, sliding in carriages  $z$ , are also secured to the under side of the bed-plate, and have cut through them the slots or grooves shaped as shewn at  $f^1$ , which act as levers for raising or lowering the cutters  $g$ . Straps or bands of iron  $h$ , secured to the back of the cutters  $g$ , connect them with the blades  $f$ , by the pins  $h^1$ , passing through both the bands  $h$ , and the slots  $f$ ; consequently, motion imparted to these sliding blades, is communicated to the cutters  $g$ , vertically: the length of these slots also governs the length of the stroke. Motion being given to the shaft  $a$ , is communicated, through the two wheels  $b$ , and  $c$ , to the double throw-crank  $d$ ; and an alternating or reciprocating movement being thus given to the blades  $f$ , the same motion, in a vertical direction, is thereby given to the cutters  $g$ ,—the one rising as the other falls. The vertical position of these cutters is maintained by causing them to work in slides formed on the one side by the bands or straps  $h$ , and on the other, by allowing the end of the cutting-jaw  $g$ , to project over the side of the standard, as shewn at  $y$ , figs. 2, and 3. By this arrangement of these cutters, the strain at the cutting point is thrown from the jaw  $g$ , back on to the holster  $p$ . The scrap falls into the spaces  $g^1$ .

The next part of the machine consists of two pairs of cutting rollers  $n$ , hung on parallel shafts  $m$ , in bearings between the holsters. These rollers are adjusted and kept in position by the screws  $t$ , passing through the heads of the holsters, and also derive their motion from the main shaft  $a$ , through a toothed wheel  $i$ , working into a large wheel  $k$ , which drives the two smaller wheels  $l$ ,  $l$ , on the shafts  $m$ .  $q$ ,  $q$ , are four sliding screws passing through the holsters, and terminating at one end in small screw wheels  $q^1$ , working into a worm on either end of the two shafts  $q^2$ , at the end of the machine, as shewn at fig. 3: these are for the purpose of adjusting the gauge of the rollers.  $o$ ,  $o$ , are two guards connecting the holsters and carrying the bridge-guides  $o^1$ ;  $r$ ,  $r$ , are two top guards

secured to the rollers, and forming guides for the plate during the process of cutting, as well as to keep the rollers in their exact position; *u, u*, are two loose crabs sliding on the main shaft *a*, for the purpose of throwing either part of the machine out of motion. The plate, having been placed under the cutting-jaw *g*, on one side of the machine, is first shorn at one end, and then passed between the cutting-rollers, by which the sides are cut: it is then shorn on the remaining end by the second cutting-jaw, on the opposite side of the machine. In many instances the shears alone are preferred—the cutting-rollers being dispensed with; and as this simply requires the holsters to be somewhat stronger, further detail is unnecessary.

The patentee remarks that he lays no claim to the use of the cutting-rollers, save in combination with the rest of the machine; but he claims the peculiar construction and application of the slots herein mentioned, operating, with the parts in immediate connection therewith, as levers in raising and lowering the shears,—whereby an access of power is gained; together with the general arrangement and combination of the remaining mechanical parts hereinbefore set forth, for the purpose of cutting or shearing iron and other metals.

---

To **HIRAM BARKER**, of Manchester, engineer and tool-maker,  
and **FRANCIS HOLT**, of Manchester, engineer, for improve-  
ments in machinery and apparatus for grinding and  
turning metals.—[Sealed 20th June, 1853.]

THIS invention consists, first, in an improved combination of parts for grinding metal balls to make them spherical. Secondly, in an improved combination of machinery applicable to turning lathes for giving a reciprocating motion to the face-plate. Thirdly, in an improved mandril or tool on which articles to be turned are fixed. And, lastly, in an improved combination of machinery for turning articles of a definite shape.

In Plate III., fig. 1, is a sectional elevation, and fig. 2, a plan, with the cover removed, of the improved combination of parts for grinding balls. *a*, is a metal chamber or dish, and *b*, is a lid or cover. Grooves are turned in this dish and in the lid, corresponding to the size of the metal balls to be ground: these balls are marked *c, c*. *d, d*, are blocks of wood or other suitable material placed between the metal balls to keep them asunder, as shewn at fig. 2. The lid *b*, is furnished with a square shank *b'*, in order that motion may be given to it by



the spindle of a drilling machine, or in any other convenient manner. The balls to be ground are taken in the state they leave the foundry, and put into the groove of the dish *a*; emery and water, or other suitable grinding materials, are then added, and the lid *b*, is put on. Rotary motion is now given to the lid, and, if the lid itself is not sufficiently heavy, pressure must be given to increase the action on the balls to be ground. It has been found from experience that six brass balls of two inches in diameter can be ground sufficiently spherical to act as valves of locomotive engine-pumps in six or seven hours; thereby producing a great saving in labour, as such ball-valves are generally turned by hand.

Fig. 3, is an elevation of improved machinery for giving a reciprocating motion to the face-plate of a lathe; *e*, is part of the spindle of a lathe; *f*, the face-plate; and *g*, the back-shaft, to the end of which is fixed a slot-lever *g*<sup>1</sup>, having an adjustable stud *g*<sup>2</sup>, the end of which takes into a sliding-block *f*<sup>1</sup>, fitting in the slot-plate *f*<sup>2</sup>, bolted to the face-plate. When the lathe is in motion, the back-shaft, in revolving, imparts a reciprocating motion to the face-plate *f*, the amount of which can be increased or diminished by bringing the stud *g*<sup>2</sup>, nearer to or further from the centre of the back-shaft.

Figs. 4, and 5, represent two views of one of the improved mandrils. *h*, is a plate to be bolted to the face-plate of a lathe. In this case the plate *h*, is shewn as forming part of the conical arbor *i*, on which fits the shell or bush *j*, which is cut open at *j*<sup>1</sup>, and is forced on to the arbor *i*, by the nut *j*<sup>2</sup>. When a wheel or other article to be turned is put on this improved mandril, the outer diameter of the shell *j*, must be such that the hole in the wheel or other article will fit easily on it. The workman, by then turning round the nut *j*<sup>2</sup>, forces the shell gradually on to the conical arbor *i*, the action of which expands the split-shell *j*, and causes its outer cylindrical surface to fit tightly the hole in the wheel or other article to be turned. By this means much labor is saved, and the injury caused by driving the mandril into the hole of the article to be turned, is avoided. By unscrewing the nut *j*<sup>2</sup>, the wheel or other article on the mandril is set at liberty. In some cases the screw and screw-nut may be dispensed with, and the shell tightened on the cone by a tube brought against and acted upon by the loose headstock centre: this mode of construction is particularly applicable for light work.

Fig. 6, represents the improved combination of machinery for turning articles of a definite shape, such as the heads of screw-bolts, or the cutters for cutting the teeth of wheels, or

other articles. *l*, is part of the bed of a lathe; *m*, is the socket of the common hand-rest, and supporting the shank of the circular plate *n*, which is provided with a lid *n*<sup>1</sup>; and *o*, is a bar, which has a spherical projection on it fitting in a spherical recess in the plate *n*, and lid *n*<sup>1</sup>. The shorter end of this bar has a cutter *o*<sup>1</sup>, fitted into it; and the longer end, which serves as a handle, is held in contact with and moved along the edge of the template or shaper-plate *p*, by the operator. This shaper-plate *p*, is bolted to a bracket *p*<sup>1</sup>, fixed by a bolt to the lathe-bed. The distance of the shaper-plate from the centre of the lathe can be varied, by passing the bolt which holds it to the lathe-bed through any of the other holes in the bracket *p*<sup>1</sup>. When the article to be turned has been fixed in the lathe, the attendant, by moving the long end of the bar *o*, along the edge of the shaper-plate *p*, imparts a corresponding motion to the cutter *o*<sup>1</sup>; thereby turning the article in the lathe to the same shape as the template; but as the distance of the cutter to the fulcrum of the bar *o*, is much less than the distance between the fulcrum and the template, it is evident that the cutter moves through a proportionably less space, and consequently the article turned is reduced in size.

The patentees claim, First,—the improvements described and shewn in figs. 1, and 2, for grinding metal balls to make them spherical. Secondly,—the improvements shewn and described in reference to fig. 3, for imparting a reciprocating motion to face-plates. Thirdly,—the improvements in mandrils, as shewn in figs. 4, and 5, and as described. And, Lastly,—the improvements in turning articles of a definite shape, as shewn and described in reference to fig. 6.

---

To EDGAR BREFFIT, of Castleford, in the county of York,  
glass manufacturer, for improvements in the manufacture  
of glass-house pots.—[Sealed 18th June, 1853.]

In the ordinary mode of manufacturing glass-house pots for melting glass, the pot is made of clay, and is supported upon a base of stone or wood or other suitable material. By this arrangement the sides of the pot, being more exposed to the air, become dry sooner than the bottom, and the pot is thus rendered liable to crack. To avoid this defect, the patentee constructs the base with a separate central portion of somewhat less diameter than the base of the pot; and when the clay has acquired a certain degree of strength and consistency,

he removes the central portion, and leaves the pot resting upon the exterior part of the base. The bottom being thus exposed to the air, dries quicker than when resting upon the ordinary base. The whole pot is thus more uniformly exposed to the air without its removal from the base on which it is built, and may safely be dried quicker than by the ordinary method. The base is made of iron, or of stone, or other suitable material. The central moveable portion of the base, and the exterior part of the same, may each be made of one or more pieces.

In Plate IV., fig. 1, is a vertical section of a glass-house pot standing upon its base; and fig. 2, is a plan of the base, without the pot. *a*, is the pot; *b*, is the external portion of the base; and *c*, is the internal portion of the same. These parts may be made of cast iron, strengthened by ribs, as shewn, or they may be made of any other suitable material. They are supported by three or four blocks *d*. The pot *a*, is constructed on this base with fire-clay, brought into a plastic state with water, and mixed or prepared in the usual manner; and as soon as the bottom has become sufficiently dry to support its own weight, the base is raised a little at its outer edge, by means of a lever or crowbar, and the blocks *d*, are drawn out a little way, so as to allow the central portion of the base *c*, to drop out; leaving the pot resting upon the external ring *b*. A support may be placed under the centre of the bottom of the pot, to prevent it from sinking with its own weight. The central portion of the base *c*, may be left under the pot, after being lowered from it, as hereinbefore mentioned; or it may be removed altogether, and employed with another external ring in the manufacture of another pot in a similar manner.

In lieu of making the base of only two pieces *b*, and *c*, as hereinbefore described, it may be made of several pieces. Thus, each of the parts *b*, and *c*, may be divided into several segments, and portions removed at pleasure, so that air may be allowed access to the bottom of the pot before it could be removed from the base on which it is built, and before the bottom is sufficiently dry to sustain itself with the aid of the ordinary partial supports. The simpler arrangement first described, is, however, preferred.

The patentee claims the manufacture of glass-house pots by constructing the same upon a base consisting of an external ring surrounding an internal or central portion, which is afterwards removed to allow of the access of air to the bottom of the pot, as hereinbefore described.

To HENRY GOODALL, of Derby, druggist, for improved machinery or apparatus for grinding or levigating various substances.—[Sealed 24th June, 1853.]

THIS invention consists in a novel or improved arrangement of machinery or apparatus, whereby the operations of grinding or levigating various substances may be performed by the aid of a pestle, or an instrument resembling a pestle, instead of by means of rollers or flat grinding surfaces. The same arrangement of machinery is also applicable for grinding flat or curved surfaces, or for mixing bread or other materials,—a tool of proper form being employed in place of the pestle required for pulverizing substances.

The substances or materials to be pulverized or operated upon are placed in a mortar or vessel, in which is made to work, by mechanical means, a pestle, grinding tool, or other suitable instrument, which by its action will grind, pulverize, mix, or levigate the materials placed in the mortar or vessel. The pestle or grinding tool is secured to a lever, which is actuated by means of toothed gear in such a manner as to give a motion similar to that which is imparted to such an instrument by manual labour. A rotary motion, on its axis, may be communicated to the pestle or grinding tool, if required. The gearing for actuating the pestle or grinding tool is driven by means of bevil-toothed gear on the main driving shaft, which is provided at one end with a winch handle, whereby it may be rotated and the several parts thereby actuated.

In Plate IV., fig. 1, is a plan view of the machine complete; and fig. 2, is a sectional elevation thereof. *a, a*, is the main framing or table, on which the apparatus is secured; and *b, b*, is the mortar or vessel in which the substances to be operated upon are placed. *c*, is a vertical arm or rod provided at its lower end with a ball or pestle. The upper end of this arm or rod *c*, is inserted in a jointed socket *d*, which is connected to the lever or arm *e, e*, by an universal joint, as shewn in fig. 2. The lever *e*, is connected to an upright standard *f*, by a joint *g*, and it may be weighted to any desired extent, according to the substance to be operated upon, by hanging weights from a hook near one end thereof; or weights may be applied direct on the shaft of the pestle, grinding tool, or instrument. Motion is communicated to the vertical arm *c*, by means of the horizontal rod *h*, one end of which is secured on a pin or stud *i*, and has a rotating motion communicated to it by the bevil wheels *p*, and *q*. The horizontal rod *h*, is

also connected, at or near its central part, to a second set of bevil wheels  $p$ , and  $q$ , by means of a pin or stud  $j$ ; so that a compound rotating motion is communicated to the ball or pestle, which is made constantly to describe a different circle, or a circle in a different place to that immediately preceding it. The studs  $i$ , and  $j$ , by which the rod  $h$ , is secured, are mounted on slides  $k$ ,  $k$ . These slides are moved to and fro by the connecting bars or rods  $l$ ,  $l$ , which are jointed at one end to the excentric pin  $m$ ,  $m$ , of the toothed planet wheels  $n$ ,  $n$ ; which wheels are mounted on pins or studs attached to the plates  $o$ ,  $o$ , in each train. These plates are secured to the boss of the bevil-toothed wheel  $p$ , which is driven by a similar wheel  $q$ , on the main driving shaft  $r$ . The pivot or stud on which the wheel  $p$ , is mounted, is provided at its upper end with a fixed or stationary pinion  $s$ , round which the planet wheel  $n$ , will be made to revolve, by the rotation of the bevil wheel  $p$ ; the planet wheel being also at the same time made to rotate on its axis by gearing into the teeth of the pinion  $s$ . The two trains of wheels which govern the motions of the horizontal rod or arm  $h$ , are precisely similar; and it is the continual change in position of the studs  $i$ , and  $j$ , effected by the sun and planet wheels, as above explained, that the variations in the circles, rotations, or revolutions described by the pestle or ball of the vertical arm  $c$ , are effected. The attendant, therefore, has only to supply the mortar or vessel  $b$ ,  $b$ , with the material to be operated upon, and then to communicate motion to the main shaft  $r$ , either by hand labour or other power, and the grinding, levigating, or mixing operation will be effected.

The patentee remarks that, although he has shewn his invention as applied for grinding, pulverizing, or levigating substances or materials in a mortar or vessel, yet it will be seen that a similar arrangement of parts may be employed for grinding or polishing either flat or curved surfaces: the same arrangement of machinery, with a suitable grinding tool or other instrument, is therefore applicable for grinding or polishing stone, marble, metal, or glass surfaces, or mixing and kneading bread or biscuits.

He claims communicating to a ball, pestle, or grinding tool, surface or instrument, by the mechanical contrivances above shewn, a compound rotary motion, whereby the ball, pestle, or grinding tool or surface, or other instrument, is made to perform a constantly varying rotary motion; so that the said ball, pestle, surface, tool, or instrument may more effectually and uniformly act upon the article or articles under opera-

tion. He also claims, particularly, the employment, for the purposes above set forth, of a vertical shaft or rod secured or held at the upper end thereof, as shewn, and actuated by any convenient mechanical contrivance. And further, he claims the application, to a horizontal shaft or rod, of duplicate cranks, excentrics, or wheels, for the purpose of communicating to a vertical rod or shaft a rotary or compound rotary motion.

---

To HENRY BESSEMER, of *Baxter House, Old St. Pancras-road, engineer, for improvements in the manufacture and refining of sugar.*—[Sealed 15th July, 1853.]

IN the process of refining sugar, as at present generally practised, the concentrated syrups are put into conical iron moulds of so small a size as to allow of their being easily lifted from place to place by the workmen, after they have been filled with syrup. This lifting of the moulds takes place several times in the course of manufacturing each loaf of sugar; and hence, with the present process, the size of the moulds is limited to that which the workmen can handle with facility. In order to displace the loaf of sugar from the mould, a smart blow is given to the open end of it, either by inverting the mould, and striking it forcibly against the floor, or it may be otherwise effected by bringing a heavy body forcibly against the floor or against the mould, while held by the workmen in a horizontal position. In order that the loaf may be detached by these means, it is necessary to give the mould a very conical form; otherwise the difficulty of removing the sugar from it by such means would be very great, if not wholly impracticable. Near the bottom of the ordinary sugar-mould, the cone is formed at a much more obtuse angle than the body of the mould; and in the centre of this lower cone is a small opening, varying from a quarter to half-an-inch in diameter,—through which the mother liquor and other syrups slowly exude.

The practice of limiting the size of the sugar-mould, as before mentioned, and the conical form given to it, cause the following disadvantages in the manufacture, which the present invention is intended to lessen or entirely remove:—The large or upper end of the loaf is always imperfectly formed, owing, in a great measure, to the cooling influence of the atmosphere; and this surface of inferior sugar is greatly increased by the conical form of the mould; while the mother liquor and other syrups are much retarded in their escape from the mould by

the diminished area through which they have to percolate as they descend in the cone,—and, more especially, as they approach the small exit aperture in the apex; while the area, through which the syrup has to force its way, is not equal to a hundredth part of the superficial area from which the syrups are drained: and thus the time occupied in the drainage and liquoring of the loaf is much greater than would be occupied by the process if moulds of a cylindrical form were used, having an escape aperture equal to the entire diameter of the mould. With regard to the height or length of the loaf, as at present manufactured—whatever the height may be—the bottom of it will always contain a certain quantity of syrup, which is there suspended by capillary attraction. The presence of this syrup lessens the value of the lower part of the loaf; it is therefore cut off, and a new point given to the loaf in a cutting machine. As the upper end of the loaf is, as was before observed, also defective, it will be obvious that a great advantage would result from increasing the length of the loaf to ten or twelve feet, instead of making it about two feet in length, as at present; since in both cases there will only be a defective part at each end; and thus a considerable diminution in the quantity of inferior sugar would take place, and a corresponding increase in the sugar of the superior kind.

The patentee constructs cylindrical sugar-loaf moulds, having a moveable bottom, so that the syrups may drain off from a surface whose area is equal to the body of the mould. The mould may in consequence be made of much greater height; because this increased area of outlet will allow the syrups to drain off quickly,—which the hydrostatic pressure of a tall column also materially assists. This increased capacity of the mould will render it much too heavy to be handled by the workmen in the usual way; it is therefore preferred to make them fixtures, or moveable only with revolving apparatus, somewhat like a turntable; and, instead of detaching the loaf from the mould by a blow, an hydraulic press, or other suitable mechanical force, is employed to push out the loaf from the mould.

In Plate IV., fig. 1, is a vertical section through the centre of the apparatus; fig. 2, a plan, shewing the position of the moulds in reference to each other; and figs. 3, and 4, are details of the same. *a, a*, are large moulds of a cylindrical form, sixteen of which are shewn in fig. 2, arranged on a circular turntable *b*, to which they are attached by angle-irons *a\**. The upper part of the moulds are kept in their places by radial rods *c*; which are rivetted to them at one end, and are

attached, in the centre, to the hollow capital of the column *d*, which is bolted at its base to the turntable *b*. The column is kept upright by diagonal stays *e, e*, which pass at their lower ends through the outer flange of the turntable. *f, f* is a large hollow cone embedded in masonry or concrete at *f\**; it is provided with a flange, the upper surface of which is turned true, and forms a support for the flange *b\**, to slide upon, when the apparatus is turned round. The under side of the table *b*, is provided with a hollow axle *b<sup>2</sup>*, which fits, at its lower end, into a step formed in the conical piece *f, f*. *b<sup>3</sup>, b<sup>3</sup>*, are webs, cast on the under side of the table, for the purpose of giving strength to the axle. *g, g*, is a cylinder having a flange *g<sup>1</sup>*, resting on the masonry, and level with the floor-line *h*. The cylinder has a leather packing at *g<sup>2</sup>*, below which there is a contraction *g<sup>3</sup>*, which fits close to the piston *i*, the upper end of which is enlarged, for the purpose of supporting the mass of sugar *j*, which is shewn resting upon it. The cylinder is filled with water; and a pump (such as is usually employed for hydraulic presses) is provided, with which the ram or piston *i*, is forced up in a manner well understood. The moulds *a*, have a vertical slit or opening made on one side of them, which extends from end to end: on each side of this slit, angle-flanges *n*, are rivetted. There are projecting pieces or lugs *n\**, formed on the angle-iron *n*, through which a clamping-screw *m*, passes. A piece of vulcanized India-rubber *z*, is put in between the angle-irons; so that when the screws *m*, are tightened, a close joint will be formed, through which the fluid matters in the mould cannot find their way. The mode of forming this joint of the mould will be seen at fig. 3, which is a horizontal section of a portion of the angle-iron and lugs before described. *k*, is a portion of the flooring of the room, above the moulds; in which floor an opening is made at *k<sup>1</sup>*, for the purpose of allowing the tilting-frame *p*, to move in. This frame moves on an axis formed on the top of an iron bracket *r*, which is secured to the floor. *s, s*, is a flat platform or carriage on wheels, running on rails laid upon the floor.

The action of the apparatus is as follows:—On the bottom of each mould, a cap *t*, is fitted with a bayonet-joint; and having a piece of vulcanized India-rubber between it, a sound joint is formed. The turntable is moved round so as to bring one of the moulds *a*, beneath the spout *u*,—by which the concentrated syrup is conveyed from the evaporating pan. When the mould is filled, the table is turned round a little further; so as to bring the next mould under the spout to be filled;



and so on until all the moulds are supplied. The apparatus may then remain at rest until the sugar is crystallized; after which the bottom of the mould is removed, and a shallow vessel is placed beneath the mould to receive the drainage. This vessel is shewn in fig. 4: the central part *v*, is filled with molasses, and placed under the mould immediately on the removal of the bottom. In order to prevent access of air, which might enter the lower part of the crystallized mass, and prevent the drainage from being equal at all parts—around the vessel *v*, is formed an annular channel *v*<sup>1</sup>, into which the syrup overflows. From the central part on one side, a short piece of pipe *w*, is joined to the channel *v*<sup>1</sup>, which conducts the fluid into a gutter *x*, by which it may be conveyed to any convenient receptacle. The liquoring may be performed in the usual way; and when the top of the mass is made even, the screws *m*, are loosened,—which will allow the mould to expand, and facilitate the removal of the crystallized mass of sugar. One of the moulds is then brought over the head of the ram *i*: water is then forced into the cylinder, and the ram is forced upwards, carrying with it the large cylindrical mass of sugar *j*. It will be understood that the movement of the ram may be effected quickly by a pump of larger diameter than is generally used in hydraulic presses, in consequence of the small amount of force required to lift up the sugar. As soon as the sugar is raised to the position shewn in fig. 1, a workman standing on the floor *k*, tilts up the frame *p*, against which the mass of sugar rests, and brings it into a horizontal position: he then rolls the sugar on to the carriage *s*, which may be made wide enough to hold several loaves,—each lying parallel to the other. The ram is lowered down by opening a cock for the escape of water from the cylinder *g*, and is made to act in like manner upon the rest of the sugar-loaves contained in the moulds; after which the caps *t*, are replaced, and the re-filling of the moulds may be proceeded with. When the loaves or masses of sugar are lifted up on to the floor above, by the hydraulic apparatus, they are placed on carriages which run on rails,—and are by this means easily conveyed to a long oven or chamber through which the rails are laid. The oven may be heated to about the same temperature as the stoves generally employed for drying sugar, either by means of steam-pipes laid along the floor thereof, or by passing a current of hot dry air, by means of a fan or other suitable means,—the air moving in an opposite direction to the sugar. The oven should be of such a length as will contain as much sugar as is made in the establishment during the period necessary for its drying;

so that every time a carriage full of sugar is pushed into one end of it, another carriage of well-dried sugar will be forced through the door at the opposite end of the oven. When this mode of drying or stoving sugar is intended to be applied to the smaller kind of loaves, several stages or floors may be made in each carriage, which may be well filled with loaves ranged on bars one above another. When crushed sugar is to be dried, the carriages may have a number of shelves, one above another, on which the sugar is laid. Or, in lieu of the carriage, an endless web or webs may be made to pass over horizontal rollers placed at each end of the oven; and the sugar, being placed on this web, will pass through the oven and become sufficiently dry by the time it is discharged at the further end.

As a certain quantity of syrup is retained in the lower part of the loaf or mass of sugar, by capillary attraction, the patentee proposes to prevent this retention of the syrup by putting into the lower part of the moulds any suitable porous or granulated substances, such as very coarse clean sand, broken flint, shot, granulated animal charcoal, or such other matters as are incapable of acting injuriously on the sugar. These substances should occupy about five or six inches in height, and be covered with a diaphragm of wire gauze or perforated metal attached to a metallic ring, and secured thereby to the interior of the mould, as shewn in fig. 5; where *d*, represents the lower part of an ordinary sugar mould; *e*, the wire gauze; *f*, the granulated substance; and *g*, a small piece of perforated metal, to prevent the granulated matter from falling out; or otherwise these substances may be contained in a bag made of a pervious textile fabric. When the plug is inserted in the bottom of the mould, as much uncrystallizable syrup is to be put in as will fill the interstices of the granulated or porous materials. To prevent the admission of the crystallizable syrup, the moulds are then to be filled with the concentrated syrup; and after crystallization has taken place, the plug may be withdrawn, when the drainage of the loaf will go on rapidly, because the passage for the fluid between the granulated substances will be more open than it is through the network of crystals forming the point of the loaf; and hence a free drainage will take place from an area equal to the size of the metallic diaphragm. The lowest part of the sugar occupies a position an inch or two higher above the escape orifice than the syrup can be suspended by capillary attraction; and hence the lower part of the loaf will be completely drained. The orifice of the mould should be dipped

into a small cup containing syrup, so as to prevent the admission of air. The cup *h*, is shewn at fig. 5, suspended by small pieces of metal *j*, which rest on the mouth of the earthen pot *k*, in which the mould is placed to drain. The syrups flowing over the edge of the cup will be received in the pot. By this arrangement the time occupied in draining and liquoring the loaf will be lessened, while the weight of the loaf sugar will be increased, since the bottom of the loaf need not be cut off as usual. When it is thought desirable to retain the pointed form of the apex, a funnel-shaped piece of wire gauze or perforated metal may be fastened in the lower part of the mould, as shewn at fig. 6, where *l*, is the mould, and *m*, the funnel-shaped piece; the space between which and the bottom of the mould is occupied by granulated substances, as before described. The bottom opening of the mould dips into the syrup cup *r*, suspended in the mouth of the pot *s*. Loaves made in this mould will have a pointed end, the whole of which will be well drained; and the time and labour now occupied in re-pointing loaf-sugar will be avoided.

---

To EDWARD JONES SCHOLICK, of *Aldingham Hall, Ulverston, Esq.*, for improvements in obtaining motive power.—  
[Sealed 20th May, 1853.]

THIS invention consists of a combination of apparatus which decomposes water by electric currents into its component gases, as is well understood. Such gases are caused to be passed into a cylinder, within which a piston works; and then, by a second electric apparatus, electric currents cause the gases to be exploded, and thus is motion given to the piston in one direction; when, the valves and apparatus being reversed in their action, the gases are admitted to the other side of the piston, and there exploded,—by which the piston is moved in the opposite direction.

In carrying out this invention, the working pistons and cylinders, and the valves used in letting on and shutting off the flow of gas, are similar to like parts of a steam-engine; and, in combination with such a cylinder or cylinders, a vessel containing water is used, and such vessel is made of about five times the cubic contents of the cylinder or cylinders employed. The vessel is to contain a quantity of water, say about one-third of its capacity, which is constantly being decomposed by a suitable galvanic battery; and the interior of the cylinder or cylinders used is also to be in connection

with a galvanic battery, in such manner that the moving of the piston may cause the connection of the two poles of the battery to be made immediately the cylinder or cylinders have become about two-thirds full of gas, and the valve or valves have cut off the further supply of gas thereto; when the exploding of the gas by the electric current will drive the piston or pistons the remainder of the stroke. This will be followed by vacuity on that side of the piston or pistons at the time the valve or valves will be opened to admit gas to the other side of the piston or pistons. It is preferred that the cylinder or cylinders used should be surrounded by the water in the vessel where the gas is obtained; and in order to get rid of the water resulting from the exploding of the gas, a tube leads from each end of the cylinder, with a valve opening outwards, by which the water will be driven back to the vessel where the water is decomposed. And in order to prevent the gas exploding in the generating vessel, a partition of wire gauze is introduced in the passage leading from the vessel to the valve or valves of the cylinder or cylinders.

The patentee claims the combination of the parts herein described.

---

*To EMILE GRILLET, of Soho-square, Gent., for improvements in renewing the teeth of files.*—[Sealed 6th January, 1853.]

THIS invention relates to sharpening the teeth of files that have become worn out from use, by the application of a corrosive agent to the surface of the file. The constant attrition to which a file is subject, gradually reduces and blunts the points constituting its cutting surface; and, in order to again render the file of service, the patentee proceeds in the following manner:—A bath of unslacked lime and potash is prepared in the following proportions:—Take one pound of lime, and mix it with two pounds of potash in one gallon of water; stir the whole intimately together, and allow it to remain until three-fourths of the liquid has passed off by evaporation. Then draw off the remaining fourth of a gallon of supernatant liquor; and, when quite cold, it is adapted to receive the files to be cleansed.

The files to be treated (after having any superabundance of greasy matter roughly rubbed off) are immersed in the liquor described, and allowed to remain therein four hours. It is advisable that the files should be placed in a stand or rack, or otherwise disposed, so that the fluid may act freely thereon. The files, after having remained four hours in the bath, are

removed and brushed, and subsequently cleansed in clean water. In order to permit of the proper action of the acid to which the files are to be subjected, it is essential the whole greasy matter should be removed in the cleansing process.

Having thoroughly cleansed the files to be operated upon by the acid, they are immersed in a dilute mixture of sulphuric acid, in the proportion of about one part of sulphuric acid to two parts of water; using it more or less dilute, according to circumstances hereafter explained. Common water may be used to dilute the acid, but distilled water is preferred. The vessel containing the acid should be rectangular, and lined with or of such material as is not or only slightly affected by the acid, such as lead or glass, or other vitreous or earthen substance. A stand or rack is fitted to the vessel to receive the files, which are held in a vertical position, and so disposed that the acid will act freely throughout the entire surface immersed. The biting action of the acid attacks the whole surface of the files immersed; the continued effect of which is to deepen the several cavities between the cutting points of the teeth, which become sharp as they were originally. In preparing the acid, the bath must be allowed to cool before the files are immersed.

The action of the acid is continued for a longer or shorter period of time, according to the character of the file. For a fine or smooth file, an immersion of about three hours will be sufficient; but files of a coarser kind, that is, with less numerous and larger teeth, will require from five to six hours: the time will, however, depend upon the strength of the acid used for the purpose. The strength of the acid may be varied according to the character of the files. During the period of immersion, the files should be withdrawn five or six times, plunged into clean water, and brushed, in order to disengage and remove from the surface of its acute interior angles the oxide of iron produced, which adheres thereto. This, if allowed to remain, impedes the action of the acid, and would render the operation imperfect, as the files would be more acted upon at one point than another, and would leave the projecting points of the teeth more exposed to the acid than the base of such teeth.

In order to prevent as much as possible the adhesion or deposit of the oxide of iron detached from the file by the acid, the files are placed in a vertical position in the bath, as before mentioned, with their points downwards, so that the angles of the teeth present as little obstruction as possible to the oxide falling away from the surface of the file, and be-

coming precipitated in the bath; some of it, however, will adhere, and must be removed by brushing as described.

An advantage in this mode of renewing files, in addition to its being comparatively inexpensive, is, that the least possible weight of metal is removed from the file; whereas, by the ordinary process of file cutting, the whole of the old teeth must be removed to accomplish the re-cutting, which so reduces the file that it is at once detected, and cannot, except in fine files, be re-cut more than once; but by the foregoing process the renewing may be repeated several times, and is so inexpensive as to render it of advantage to wear the files much less than usual before renewing.

The patentee claims renewing the teeth of files by the action of acid, substantially as described.

---

*To WILLIAM NEWTON, of the Office of Patents, 66, Chancery-lane, in the county of Middlesex, civil-engineer, for improvements in the process of coating cast-iron with other metals, and the alloys of other metals,—being a communication.—[Sealed 5th August, 1853.]*

THE first part of this invention consists in coating cast-iron permanently with copper, by depositing the copper, by galvanic action, from a solution prepared by first taking a saturated solution of sulphate of copper in water and precipitating with carbonate of potash, and then re-dissolving in cyanide of potassium, whether the copper be deposited directly on the surface of the cast-iron or on zinc previously deposited thereon.

The second part of the invention consists in coating cast-iron with the alloy of copper called brass, by first coating the cast-iron with copper, or zinc, or both, and then depositing the brass thereon, by galvanic action, from a solution formed by mixing with the solution of copper employed in the first part of the invention, a solution of zinc prepared in substantially the same manner. The iron articles, thus coated, may be subsequently coated with silver or gold, so as to give them the appearance of these latter metals.

The articles of cast-iron to be coated or plated are first to be cleansed by what is known as the "pickling" process, with dilute sulphuric acid, and then "scratch-brushed," as it is termed, to free the surface from scale, sand, and other foreign substances which may not have been removed by the acid; and after this the castings are to be immersed in dilute nitromuriatic acid. Any other mode of thoroughly cleansing the surface may be substituted for that above indicated.

A solution of zinc is then prepared in the following manner:—Dissolve the sulphate of zinc in water until the water is saturated, and precipitate by means of prussiate of potash. The precipitate is then collected in a filter, and re-dissolved in cyanide of potassium. This constitutes solution number one.

A solution of copper is then prepared in the same manner, by dissolving sulphate of copper in water, and precipitating with carbonate of potash: this precipitate is dissolved in cyanide of potassium, and is called the second or copper solution.

The third, or what may be termed the brass solution, is then prepared by mixing together the first or zinc solution with the second or copper solution, in such proportions as to produce the shade of color required,—increasing the proportional quantity of the one or the other at the discretion of the operator.

The iron castings having been thoroughly cleansed, are first immersed in the first or zinc solution, and the galvanic-battery applied in the usual manner of electrotyping, and continued until the required thickness of zinc is deposited on the surface of and caused to unite with the surface of the cast-iron, which is a carbonate of iron. The castings, thus coated or plated with zinc, are then to be immersed in the second or copper solution, and the galvanic battery applied, as with the first or zinc solution, and continued until the required thickness of copper shall have been deposited.

In this way it will be found that the copper coating has become thoroughly attached to the zinc, and the zinc to the iron, so that they cannot be removed except by filing or cutting, as in the case of a solid mass of copper; so that articles, of whatever form desired, which can be made of cast-iron, that is, of carbonate of iron, can be coated with copper, so as to answer nearly if not all the purposes to which they could be applied if made of solid copper; thus greatly economizing the cost.

After the surface of cast-iron has been coated with zinc, or with copper, or with zinc and then with copper, which latter is much the best, if it be desired to coat it with brass, it is to be immersed in the third or brass solution, and the galvanic-battery applied, until the required thickness shall have been deposited. In doing this it is important that the positive pole of the battery should be made of brass, and as nearly as practicable of the shade of the brass to be deposited; for if a copper pole be applied, it will deposit in excess the copper portion of the solution.

If desired, the brass can be deposited on the coating of zinc instead of the coating of copper; but it will be found de-

cidedly better to deposit the brass on the coating of copper, whether the copper be deposited directly on the cast-iron or on a coating of zinc, although the latter is the best. In this way articles are produced, having all the appearance and answering nearly if not all the same purposes as if made entirely of brass, and at much less cost. The cast-iron being thus coated with brass, the surface may be bronzed in the usual and well known manner of bronzing brass; and as the process of bronzing on brass and copper is well known, it will be unnecessary to give a detailed description of it. The surface of the cast-iron being thus coated with brass, or with copper, can then be coated effectually with silver or gold in any of the well known modes of coating brass or copper with those fine metals; it will not, however, be necessary to give the details of such mode or modes, as they are well known in the arts. The patentee remarks that it will be found better to deposit the silver or gold on the brass coating than on the copper coating, on account of the color,—particularly when, from reasons of economy, it is desired to make the coating of fine metal very thin.

The patentee claims the process herein described, or any mere modification thereof, for coating cast-iron (carbonate of iron) with copper, by causing the copper, from a solution such as above described, to deposit, by galvanic action, directly on the surface of the cast-iron, or on the zinc previously deposited thereon, as set forth. And also the process herein described, or any mere modification thereof, for coating cast-iron with the alloy of copper, known as brass, by causing the brass, from a solution such as above described, to deposit, by galvanic action, on to the surface of the cast-iron, previously coated with zinc, or copper, or both, as specified.

---

*To HENRY BROWNING, of Bristol, in the county of Somerset, painter, for improvements in preparing compositions for coating iron and other ships' bottoms, and other surfaces.*

—[Sealed 18th January, 1853.]

THIS invention consists in combining white or red lead (without oil), black lead, and sugar of lead, with gum-copal dissolved in spirits of turpentine. This compound is said to be peculiarly suited for the first coating; and it is found that the sugar of lead may be reduced in quantity, or left out, for the subsequent coatings.

In carrying out this invention, the proportions of the



above-mentioned ingredients may be varied; but it is preferred to use them in the following proportions:—One part of white-lead, by measure; one part, by measure, of red-lead; one part, by measure, of black-lead; and one-quarter part, by measure, of the sugar of lead. If it be desired that the color of the paint should be lead-color, the red-lead is left out. These matters are ground with spirits of turpentine, and, when for use, gum-copal, dissolved in turpentine (white copal varnish), is added; and, in this state, the combined matters are applied, as a paint, to the coating of ships' bottoms,—applying a thin coating at first: the sugar of lead may be dispensed with in the second and subsequent coatings.

The patentee claims the combination of materials herein described, for coating iron and other ships' bottoms, and other surfaces.

---

*To GEORGE EDWARD DERING, of Lockleys, in the county of Herts, for improvements in electric telegraphs.*—[Sealed 15th August, 1853.]

THIS invention is applicable to submarine telegraphs, and also to the means of communication by under-ground or over-ground wires. Heretofore, in constructing electric telegraphs, where the whole circuit has been made of metal, and also where the conducting property of the earth has been employed as a part of the circuit, it has been usual, and it has been considered absolutely necessary, to cause the wires to be thoroughly insulated each from the others and from the earth: the consequence of which has been that the expense of laying down electric circuits for electric telegraphs has been very great, particularly where the same have crossed the sea or other waters; where not only have the wires been insulated from one another, and from the water or earth, but, in order to protect the insulating matter from injury, great cost has been caused by the use of wire-ropes or other means of protection. Now the patentee has discovered that a metallic circuit, formed of wires either wholly uninsulated or partially so, may be employed for an electric telegraph, provided that the two parts of the circuit are at such a distance apart that the electric current, or a portion of it, would meet with more resistance in passing from one wire to the other by the water or the earth, or by imperfect conductors which the wires may be attached to or suspended from, than in following the wire. And for this purpose he causes the two wires (which may be of plain galvanized iron, either uninsulated or partially in-

ulated by a coat of varnish or otherwise) of which a circuit of an electric telegraph is to be formed, to be placed in the water or in the earth, or otherwise conducted, at a distance apart proportionate to the total length of the circuit. These wires he insulates, where they approach one another to communicate with the instruments and battery, or source of electricity, or with a continuation of conductors for carrying on the current, in order to prevent the current passing through the diminished space between the wires. And in the case of intermediate stations, the wires are insulated for a distance in each direction from the instruments, in order to ensure the current making the circuit of the instruments, and not passing in a large proportion through the earth or water, or other conductors, between the uninsulated parts of the wire on each side of the station. The batteries employed to work telegraphs through circuits, after these principles, are to be constructed in the proportion of their parts, and in all respects in conformity with the well known laws which regulate the transmission of electric currents through circuits, from which a portion of the current is diverted by intervening liquids or partial conductors, and the proper distance at which to place the conductors from one another is determined by the same laws; all of which will be readily understood by persons conversant with the principles of electrical science.

Another method of carrying out this invention consists in establishing electrical communication by means of circuits composed in part of the uninsulated or partially insulated conductors described, and in part of the conducting property of the sea or other water across which the communication is to be carried, or of the earth, or the moisture contained therein, in the case of land telegraphs. For this purpose, instead of establishing the connections with the earth or water near to the extremities of the conducting wire, as when the ordinary insulated wires are employed, the connection is effected at such a distance in a lateral direction from the conductor, that the current, or a sufficient portion of it, would meet with more resistance in passing direct from the earth or water connection to the conductor than in passing to the similar earth or water connection arranged at the other extremity of the line. The communication between the conducting wire and the earth or water connection, is to be effected at each end of the line by wires effectually insulated, the same as described with reference to the communication by means of two distant metallic conductors, uninsulated, or partially so; the only difference of the present arrangement

being, that the conducting property of the earth or water is employed as a substitute for one of those conductors. The connection with the earth may be effected in the manner usual in telegraphs having insulated line wires; or, in some cases, plates of dissimilar metal or material may be employed at the two extremities, having a tendency to generate an electrical current when the circuit is complete; and this current may be applied to signalling purposes;—and galvanic batteries may be employed as auxiliary to it, if desirable.

Another method of carrying out this invention consists in establishing electrical communication by placing in the earth or water two or more wires of dissimilar metal or material, having a tendency to generate a current of electricity by the action of the water or moisture with which they are in contact. If at one extremity the wires be attached respectively to the two ends of the coil of an electro-magnet, or other telegraphic apparatus, it will be found that this instrument is acted on by the electrical current generated by the wires. If now at the other extremity of these wires a direct connection be established between them, a portion of the current generated will at once pass by this path instead of passing round to the electro-magnet, or other apparatus, and the action here will consequently at the same moment be diminished; and if means be adopted to indicate the greater or less power of the passing current, signals may thus be transmitted by making or breaking, at pleasure, the connection at the opposite extremity of the wires. In order to enable signals to be transmitted from and to either extremity of the line, each extremity may be provided, both with the apparatus to indicate the passage of the current, and the means of making and breaking the connection between the outstretched wires; and intermediate stations may be provided with similar arrangements, placed either in circuit of one of the wires, or so as to form a connection between the two. The means of carrying out this part of the invention may be greatly varied, and, if it be desirable, electrical currents derived from galvanic batteries, or other sources, may be employed as auxiliary to those generated in the outstretched wires.

In the different means of communication described, if strong conductors are required, as in submarine lines, wire-rope may be employed in place of the whole or any portion of the wire, to conduct or generate the electrical current; or chains may be employed; or wires or wire-ropes may be protected from injury by being attached to chains, spirally or otherwise, and they will conduct the current more readily

than the detached links of the chain ; or they may similarly be attached to hempen ropes, or enveloped within them. The wire, or wire-rope, or chain, may be formed of iron or copper, or any suitable metal, and coated with other metals, if desirable ; and it may be coated with some suitable varnish, by which means the amount of exposed surface will be diminished, and the metal preserved from corrosion. The electrical currents to be employed may be derived from galvanic batteries, or by induction from magnets or currents of electricity, or from any other suitable source. It is found in practice that from one-twentieth to one-tenth the total length of the line-wires or conductors, is an effective distance to place them apart from one another. And with regard to the currents of electricity employed, it is deemed advisable that they should possess the properties generally understood by the term "quantity" of electricity in a considerably greater degree than is usual for telegraphing by insulated wires, which may be effected, if galvanic batteries be employed, by the use of plates of larger dimensions, or by other alterations in the exciting liquids or plates, as is well understood.

In order to explain more clearly the means of carrying out this invention, the patentee supposes the case of a line to be carried out, upon the principles described, from Holyhead to Dublin, a distance of about sixty miles. For this purpose it would be necessary, first, to select two points on each coast, at a distance apart of, say, from three to six miles, and to unite together the two points on each coast by an insulated wire. Next, the two northern points are to be connected together by a submerged uninsulated conductor, and the two southern points by a similar conductor, as near as may be parallel to the first, unless the water be employed as a substitute for one of the conductors, in the manner described. Thus an oblong parallelogram of continuous conductors is formed, having for its longer sides the uninsulated conductors, and for its shorter sides the insulated wires along the coast. And if now the coast wires, on each side, be divided at any parts, or disconnected from the sea wires, and instruments and batteries introduced into the circuit, signals may be transmitted by any of the means ordinarily employed with insulated line-wires. Or, to take the case of a longer line, suppose it were desired to unite Great Britain with America : two points are selected in each country, at a sufficient distance apart from one another ; say, the Land's End in Cornwall, and the Giant's Causeway in Ireland, or some suitable point on the west coast of Scotland, and corresponding points on

the American coast. Next, the two points in each country are united by insulated wires, and, finally, two uninsulated conductors are submerged across the Atlantic; or one, if the water be employed to complete the circuit. Then, by introducing telegraphic instruments and batteries into the circuit of the land wires, the communication will be established. The patentee remarks, that for crossing wide seas, such as the Atlantic, where difficulties might arise as to the stowage of a sufficient length of conductor, this plan possesses peculiar advantages; inasmuch as the space ordinarily occupied by insulated wires is avoided; and, at the same time, nearly equal strength is obtained; and thus a far greater length of line may be coiled in the same compass. The patentee considers, that in deep water, beyond the reach of ships' anchors, a single wire will effectually answer for each conductor, provided it be of good material and sufficient strength to bear the strain of laying down. The method of carrying out the various modifications of this principle, and its application to land telegraphs, will be readily understood from the examples here given.

From the foregoing description it will be seen, that the cost of laying down electric telegraphs, whether submarine or otherwise, is, by this invention of employing distance between the conductors as a means of insulation, reduced to little more than the mere cost of the conductors for the current, together with that of an insulated wire at each end of the line to complete the circuit between the extremities of the uninsulated conductors; and the numerous difficulties which attend the insulation of long lengths of wire are avoided, as also the chances of the communication being interrupted by accidents to the insulation.

The patentee claims the use of the element of distance between uninsulated or partially insulated wires or conductors, as a means of insulation for telegraphic purposes, whether such wires be employed merely as conductors, or also as generators of electrical currents; and whether or not the conducting power of the earth, or the moisture thereof, or any body of water, be employed as one conductor.

---

To JOSEPH SPENCER, of Bilston, in the county of Stafford,  
iron-founder and engineer, for a new or improved cupelo.  
—[Sealed 13th June, 1858.]

THIS invention consists in making the cupelo used for fusing cast-iron, double; that is to say, in adding to the ordinary

cupelo a second cupelo or reservoir for containing an additional quantity of iron, such reservoir or second cupelo being so connected with the first that the fused iron in the second cupelo may be drawn off from the tap-hole of the first. The reservoir or second cupelo may, however, be so arranged that it may be used by itself; that is to say, the iron contained in it may be drawn off, when required, from its own tap-hole.

The patentee does not think it necessary to describe the mode in which two cupelos or a cupelo and reservoir may be combined, as that may be varied according to the circumstances of each particular case.

He claims the adding to the ordinary cupelo a reservoir or second cupelo,—the said second cupelo or reservoir being so arranged with respect to the first cupelo that the contents of the first cupelo and reservoir or second cupelo, may either be drawn off separately, or both from the same tap-hole; that is to say, the contents of the cupelo and reservoir drawn off from the tap-hole of the said cupelo when a larger quantity of iron is required than can be contained in one cupelo.

---

*To WILLIAM ALDRED, of Manchester, bleacher, RICHARD FENTON, of Prestwich, waste-dealer, and WILLIAM CRONE, of Salford, fent-dealer, all in the county of Lancaster, for certain improvements in separating or recovering the wool from cotton and woollen or other similar mixed fabrics; whereby the wool is rendered capable of being again employed.*—[Sealed 12th August, 1853.]

THIS invention relates to the recovery of the wool or animal fibre from any woven fabrics, old or new, wherein the wool or animal fibre is mixed with cotton, flax, or other vegetable fibre, and consists in destroying all the vegetable fibre by means of mineral acid or gas, and afterwards neutralizing and extracting the said acid or gas, so as to leave the wool or animal fibre in a fit state to be again carded and spun. In carrying out this invention the mixed goods or fabrics (or those composed of both animal and vegetable fibre) are first to be immersed in a bath containing a solution of any mineral acid, or combination of mineral acids, such as the sulphuric, nitric, and hydrochloric, or any other acids which are peculiar to the mineral kingdom; or they may be submitted to the action of the vapor or gas evolved from such acid or acids. They are then to be exposed to a high temperature. The goods are then to be washed in lime-water, in order to neutralize the acid or gas,

and are subsequently to be washed in urine, or ammonia, and dried. The cotton or vegetable will then be found to be entirely destroyed, and all traces of the mineral acid or gas be removed from the wool or animal fibre. It is merely necessary then to pass the wool through a suitable opening and cleaning machine, for opening the fibres of the same, and removing therefrom the dust (which may be shaken out) remaining after the destruction of the cotton or vegetable fibre. The wool is then in a fit state to be again carded, spun, and woven.

The patentees claim the above particularly described process of separating or recovering the wool from cotton and woollen or other similar mixed fabrics, by the destruction of the vegetable fibre or material, by the agency of mineral acid or acids, or by the gas or vapor evolved from such acid or acids; and whereby the wool or animal fibre is left intact, and almost in its original state, and thus rendered capable of being again employed.

---

*To BUCKLEY ROYLE, of Manchester, manufacturer, and WILLIAM MAC EWAN CHELL, of the same city, salesman, for a certain method of treating silk-waste arising from winding, warping, and weaving silk, and rendering it capable of being spun or otherwise employed.—[Sealed 15th October, 1853.]*

THIS invention relates to a method of treating silk-waste, whereby the fibre of the waste is reduced to such a state as to render it ductile, and capable of being opened by carding or teasing, like cotton or wool; and of being subsequently prepared and spun upon the ordinary preparing or spinning machinery, as employed in the processes of preparing and spinning cotton and wool. Hitherto silk-waste arising from the machinery employed in the operations of winding, warping, and weaving, has not been made or rendered in any way available or capable of being spun, owing to its entangled and knotty condition, and the extreme length and tenacity or strength of its fibres, and a serious loss has been consequently thereby occasioned. Now this invention consists in reducing the fibre of such silk-waste by cutting it up into lengths sufficiently short to suit the purpose required. The fibre of the silk is thus reduced to any required length, as may be found desirable, according to the quality of the thread to be spun; and it becomes thereby reduced to a state similar to that of raw or unmanufactured cotton or wool; and, after such

*Brooman's, for Producing Castings in Malleable Iron.* 119

cutting process, it is capable of being opened, teased, carded, drawn, and spun in a similar manner, and by means of machinery similar to that employed in such processes for the preparation and spinning of cotton and wool; thereby rendering it a valuable product for the manufacture of silk or mixed fabrics. The said process of cutting may either be performed by hand, or by means of any suitable machinery adapted thereto. A machine somewhat similar to an ordinary chaff-cutting machine would answer the purpose, consisting of a box or trough to contain the silk-waste in the rough state as collected, a pair of fluted rollers for pressing or drawing the waste forward, so as to bring it under the action of a series of revolving knives or cutters, for cutting up or reducing the same to the required length of fibre, which can of course be varied according to the quality of the thread to be spun; or any other suitable arrangement of cutting machinery may be as readily adapted to this purpose. The patentees remark, that, by selecting and assorting the colors of the said silk-waste previously to its being cut (which process would be both easy and inexpensive), no subsequent operation of dyeing or staining the spun silk threads will be required.

They claim reducing or preparing of the fibre of the said silk-waste by cutting it up into sufficiently short lengths to suit the purpose required (whether the said process of cutting be performed by hand, or by means of suitable machinery), in order to bring the said fibre into such a state as to admit of its being prepared and spun, or otherwise employed in a similar manner and by similar machinery to that ordinarily employed in the processes of preparing and spinning, or otherwise treating cotton and wool.

---

To RICHARD ARCHIBALD BROOMAN, of Fleet-street, for a method of producing castings in malleable iron,—being a communication.— [Sealed 12th August, 1853.]

THIS invention consists of an improved method of preparing wrought-iron, so that it may be capable of being poured or cast into moulds for the production of malleable castings or articles which shall have all the strength and qualities due to wrought-iron. The invention is designed chiefly for the manufacture of railway-wheels; but is equally applicable to the production of other articles.

The process is as follows:—The metal employed may be either scrap wrought-iron, or bars or plates cut into small



pieces, and the melting is to be performed in crucibles, such as are used for melting blistered steel. The operator weighs out the iron in quantity proper for a charge in the crucible according to its size; he then mixes with the iron about one-half of one per cent. of charcoal by weight, or of any other suitable carbonaceous matter which will afford that proportion of carbon; and finally adds one per cent. of manganese, and one per cent. of sal-ammoniac. These materials are to be placed in the crucible, which is then to be covered, as the melting must be performed out of contact with the atmosphere. The crucible is then introduced into a proper furnace, where a fire is raised, and a heat obtained sufficient to reduce the iron to a melted mass, which temperature is at about 15,000° Fahr. This degree of heat must be maintained for about three hours, when the material will be in a state fit for pouring into the moulds.

Railway carriage-wheels, formed of this material, can be cast with a chill, as in the case of common iron castings; and they will moreover be malleable, so as to be capable of being treated under the hammer in the forge, and formed into other shapes. In the making of other articles, not requiring to be chilled, they may be subjected in like manner to alterations in shape, or otherwise be treated as malleable wrought-iron is usually worked.

Articles may also be manufactured having part of their shape made in the moulds, and their form completed by forging. Thus, intricate shapes and ornamental work may be accomplished with great facility and in a superior manner; thus forming articles highly ornamental, as well as those for mere utility.

The patentee claims the method of treating malleable iron so that it may be capable of being used in the production of malleable castings, as hereinbefore described.

---

*To GEORGE ROBINSON, of the town and county of Newcastle-upon-Tyne, physician, for the novel application of the slags or refuse matters obtained during the manufacture of metals.—[Sealed 27th August, 1853.]*

THIS invention consists in the conversion of the molten slag (formed in the various processes of manufacturing, puddling, and refining iron and other metals) into sheets or plates, by pouring it upon an iron or other table artificially heated, whereon it may, by means of rolling or pressing, be reduced to

any requisite thickness, according to the purpose for which it is intended to be used. The plates, thus formed, are afterwards annealed by being allowed to cool gradually in any suitable furnace; and may be employed for roofing and other useful purposes for which they may be considered applicable.

The slags best adapted for the formation of sheets or plates, by the processes about to be described, are those of a metallic appearance, and which are more or less crystalline in structure, and contain iron or other metals, in various proportions, combined with silica and other earthy substances. They are variously termed, but may be easily recognized by the above description.

These slags or refuse matters are to be used while in a fluid state; that fluidity being derived either from the heat of the furnace in which they are first formed, or from their being afterwards re-melted in any convenient manner. In order to form from these refuse matters the sheets or plates required, the molten slag is poured upon an iron or other table, artificially heated, and is pressed or rolled out thereon, by suitable machinery, to any requisite thickness, after the manner used in manufacturing plate-glass, or by any other suitable mechanical arrangements, which will readily suggest themselves to any intelligent mechanic. The sheets or plates, thus formed, are at once to be transferred to a suitable annealing furnace, previously heated, and there allowed to cool gradually, for from six to eight days, or even less. When cold, the sheets may be employed for roofing buildings, covering walls, and for many other useful purposes.

These sheets or plates, while in a plastic state, may likewise be cut, perforated, and ornamented by means of suitable elevations and depressions on the rollers by which they are formed. For instance, rough sheets of suitable thickness having been obtained on the table, slabs with mouldings or other ornaments thereon may be produced, by causing dies or engraved or ornamented rollers to press on the upper surface of the sheets, and produce any impression that may be required. These slabs must, of course, be annealed in the same way as the thin sheets above mentioned.

The patentee remarks that he is aware that slags have heretofore been cast into blocks in moulds, and have been employed for paving and such like purposes; he does not, therefore, intend to claim the application of blocks cast in moulds, nor does he intend to confine himself to any particular mechanical contrivances for forming the sheets or slabs, as above mentioned; but he claims, First,—the formation of

sheets, plates, or slabs, of various thicknesses, from the slags or refuse matters obtained during the manufacture of metals, by rolling or otherwise pressing the molten slag on tables artificially heated. And, Secondly,—the application of the sheets, plates, or slabs, thus formed, to roofing and other useful purposes.

---

*To GEORGE BELL, of Powell-street, Goswell-street, in the county of Middlesex, Gent., for improvements in obtaining liquid cement, and pigments or paints.*—[Sealed 11th May, 1853.]

THIS invention relates to combinations of lime with certain other matters in the production of liquid cements, pigments, and paints.

In carrying out this invention, when it is required to produce a liquid cement suitable for outside walls and other like situations, the following matters are mixed in the proportions given:—viz., six bushels of slacked lime, one pound of sulphate of iron or zinc, one quarter of a pound of sal-ammoniac, ground in a little water; six pounds, or thereabouts, of ochre, and six pounds, or thereabouts, of umber, being added thereto to give the required tint to the mixture. If the mixture, when ground, is not sufficiently fluid for use, the same may be rendered so by the admixture therewith of water to the extent desired.

To produce a liquid cement or color, having a more adhesive character, and suitable for inside walls and other situations, six pounds weight of gum-arabic, and one and-a-half pounds of bees'-wax, are added to, and dissolved and mixed with the above.

To produce a black paint for common purposes, the following matters are combined in the proportions given:—Two pounds of slacked lime in powder; two pounds of sulphuric acid, diluted in one gallon of water; and ten gallons of gas tar. These are mixed together in any suitable stirring apparatus, and are then fit for use.

An elastic paint, suitable especially for damp walls, but applicable for other purposes, is produced by combining one hundred-weight of oxichloride of lead or oxide of zinc, twenty-eight pounds of slacked lime, dry, and one gallon of a solution of India-rubber, diluted with one part of linseed oil, and two parts of spirits of turpentine. In obtaining this latter combination, the oxide of zinc or oxichloride of lead is

first mixed with linseed oil by grinding, and then the other matters are added as may be desired.

An oil suitable to be used for thinning the last-mentioned combination of elastic paint, may be obtained by combining one gallon of spirits of turpentine, half a gallon of turpentine varnish, one pint of linseed oil, and one pint of rosin oil.

Each of the above combinations may be applied by brushes in the ordinary manner of applying paint.

---

To CHARLES BREESE, of Birmingham, in the county of Warwick, japanner, for a method of forming designs and patterns upon papier-maché, japanned iron, glass, metal, and other surfaces.—[Sealed 19th July, 1853.]

THIS invention consists in first producing a pattern or design upon paper by printing from stone or other surface, in some adhesive material or composition, which is transferred to the surface intended to be ornamented. The paper is removed, and the pattern has applied thereon some material or composition in a finely-pulverized state, which will resist the action of acids or other agents employed to act upon that part of the surface not covered by the pattern. Or, instead of the pattern being so treated only after being transferred, in some cases it is submitted to the like treatment on the paper, then transferred, the paper removed, and the process proceeded with as above described. When required to ornament glass and metal surfaces with vitrifiable colors, or with metals, the process known in the trade as burning in is employed. The vitrifiable colors or metals (in the state of powder or leaf) are rubbed into, mixed with, or applied on the pattern produced in the resinous or other material or composition aforesaid. When not required for burning in, and for the purpose of producing designs and patterns in colors, or in gold, silver, or other metal, the pattern is produced in an adhesive composition as aforesaid, and has applied thereon the gold, silver, or other metal, in the state of powder or leaf; the superfluous metal being wiped away or removed from those parts where the adhesive composition has not been applied. Or the whole surface is covered with gold or silver leaf, and the pattern, produced in an adhesive composition, and sprinkled with a resinous powder, is applied thereon. The gold or silver leaf is removed from those parts which the pattern does not cover, by biting with acid or by simple rubbing. The resinous composition is next washed off with spirits of turpentine or other solvent, and the pattern appears in bright gold or silver.

In carrying out this invention, the pattern is first drawn or otherwise produced upon stone, copper-plate, or other surface, or in type, in the usual way, and an impression in an adhesive matter or composition is obtained upon paper or other suitable fabric. A good adhesive composition for the purposes of this invention may be formed as follows:—Linseed oil, boiled till it assumes the consistence of putty, and thinned to the required consistence for printing with, that is, about that of ordinary printing ink, by the addition of gold size, to which is afterwards added a portion of pitch. The pattern is transferred to the glass intended to be ornamented, whether plain or colored (supposing the pattern to be produced on glass), and the paper moistened (when necessary), and drawn off. Some material or composition which will resist the action of acids or other agents, such as finely-powdered asphaltum, or anthracite coal reduced to fine powder, is then applied; or, in some cases, metal or other leaf which adheres to the pattern only, and renders it impenetrable to the acid or agent to be afterwards employed, is used. In some cases heat is applied, or time is allowed, with or without exposure to the vapour of spirit or oil, to enable the resinous or other material or composition employed to incorporate itself with the impression; and then fluoric acid (or other material having similar properties) is applied in the usual way on the face of the glass. The acid will bite away from every part of the glass where the pattern does not extend, and will leave the pattern untouched.

In some cases the resinous or other powder is applied before as well as after transferring the pattern, and the operation is then proceeded with as follows:—Supposing the pattern to have been produced upon paper in the ink usually employed in lithographic printing, while the ink is still wet or damp, a resin or resinous composition reduced to powder is applied thereon. The paper is exposed to the vapour of turpentine in order to cause the resin and oil in the lithographic ink to combine and form a varnish. Or, instead of exposing it to the vapour of turpentine, it may be exposed to heat, or even allowed to remain a certain time, when the matters will of themselves combine and form a varnish. The pattern is then transferred on to the article to be ornamented, and the paper on which the pattern had been produced and treated as aforesaid, is either stripped or washed off. In some cases an adhesive composition of a watery character is used for obtaining the impressions for the purpose of transferring. Gum or other suitable substance, in a state of powder, is then applied to the printed parts of the impression, either before, or after

transferring, or both before and after; and the process is proceeded with in other respects as before described. For the purpose of dissolving the gum applied as aforesaid, the surface is exposed to the vapour of water, or left for a short time exposed to a damp atmosphere, instead of using the vapour of oil or spirit, and heat, as directed in the case of the resinous composition. When it is desired to obtain an impression of a very adhesive character, a lithographic stone or metal plate is employed, having those parts of the surface on which the pattern is produced, in relief, or raised above the other parts of the surface of the stone or plate.

For forming designs in vitrifiable or fusible colors or metals on glass, china, and other suitable substances, the pattern produced by printing in an adhesive material is first taken; with or without the addition of the resinous composition, and transferred as before; and the coloring medium is then rubbed into the pattern; or, if metal, it may be applied in the state of powder or leaf. The article is next subjected to heat, when the composition will disappear, and the color or metal will adhere by fusion to the surface of the article. In some cases the coloring medium may be mixed with the adhesive composition before obtaining the impression, or it may be applied to the impression before transferring it to the surface of the article.

For producing patterns in dead gold, silver, and metal leaf or bronze powder, upon hard or bright surfaces (such, for instance, as japanned iron, papier-maché, oil-cloth, &c.), the pattern is first obtained in an adhesive composition as aforesaid, and transferred to the surface; the leaf or powder is then applied, and wiped off from those parts where the pattern does not extend. When necessary, the article may be subjected to the usual after processes of stoving, varnishing, polishing, &c.

For producing designs and patterns in burnished gold or silver, gold or silver leaf is first applied by means of the ordinary gilding water, or in such manner as to cause it to adhere sufficiently to the surface of the article to be ornamented. A pattern or design produced in some adhesive composition, sprinkled with a resinous or other powder as aforesaid, is applied thereto, and the gold or silver leaf is removed from all parts which the pattern does not cover, by means of an acid, or by simply rubbing it off. The material or composition is next washed off, and the pattern is covered with spirit of turpentine or other solvent, when it will appear in bright gold or silver.

This process is also applicable to ornamenting metallic surfaces covered with gold or silver by what is known as the amalgamation process. In this case an impression is obtained in a resinous composition, as aforesaid, and transferred to the surface to be ornamented; and acid or other agent is then used to bite away or remove the gold or silver from those parts not protected by the transferred impression. The resinous composition is finally removed by washing with spirit or other solvent.

For the purpose of ornamenting marble, wood, &c., impressions, obtained as aforesaid, are transferred to the surfaces thereof (those in watery compositions are, however, preferred), and dyes, pigments, or varnishes, or any required color, are then applied to the surface; after which the transferred impression is removed, and the pattern of the original color is left, surrounded by a ground of the color produced by the dye, pigment, or varnish.

The patentee claims the method of forming designs and patterns upon papier-maché, japanned iron, glass, metal, and other surfaces, by printing any required design or pattern in an adhesive matter or composition; which design or pattern, so produced, is transferred to the surface to be ornamented, and has applied thereon, either before or after transferring, or both before and after transferring, a substance or composition possessing the properties hereinbefore described, whether employed to stop out the action of acids or other agents applied to those parts of the surface not protected by the pattern; whether vitrifiable colors, or metals in the state of leaf or powder for burning in are rubbed into or applied on it; whether colors in the state of powder, or metallic powder, or metal leaf are applied thereon, or mixed therewith; or, finally, whether employed to protect a surface of gold or silver leaf, all as hereinbefore described.

---

---

### **Scientific Notices.**

---

#### **PROTECTION OF DESIGNS & INVENTIONS CONTAINED IN THE PARIS EXHIBITION OF 1855.**

In anticipation of the demands which may be expected to be made for the protection of new and unpatented inventions and designs intended to be exposed to view in the Exhibition of Industry, to be held in Paris in the coming year, are the

following (among other) provisions contained in the decree recently issued by the French Government for the regulation of this great undertaking :—

**ART. 53.** Any exhibitor, inventor, or legal proprietor of a process, machine, or design, in a manufacture admitted to the Exhibition, and not yet deposited or patented, who shall make application for that purpose, before the opening, or within a month from the opening of the Exhibition, may obtain from the Imperial Commission a certificate descriptive of the article exhibited.

**ART. 54.** This certificate shall assure to the petitioner the property of the object described, and the exclusive privilege of working it, during the space of one year from the 1st May, 1855, without prejudice to the patent which the exhibitor may take, in the ordinary form, before the expiration of that term.

**ART. 55.** All applications for inventors' certificates must be accompanied by an exact description of the object or objects to be protected, and, if necessary, by a plan or drawing of the said objects.

**ART. 56.** These applications, and also the decision which shall have been given, shall be inscribed upon a register kept for that purpose, and which shall be afterwards deposited at the Ministry of Agriculture, Commerce, and Public Works (Office of Industry), to serve as proof, during the time determined, of the validity of the certificates.

**ART. 57.** The delivery of these certificates shall be gratuitous.

---

## INSTITUTION OF MECHANICAL ENGINEERS, BIRMINGHAM.

(Continued from p. 61.)

The following paper, by Mr. BENJAMIN FOTHERGILL, of Manchester, was next read :—

### *On the Combing of Fibrous Materials.*

In investigating the various mechanical contrivances for combing fibrous materials, a reference has necessarily to be made to the instruments originally contrived for the accomplishment of this object; and there appears no doubt that the common or ordinary comb, made sufficiently long and strong in the teeth, was first used for this purpose. The defects of that instrument, however, would soon become apparent; and the necessity for additional numbers of rows of pins or teeth would naturally present itself: so that the operator might be able to collect and hold the various lengths of the fibres of wool as he lashed or looped them on to the teeth of the comb.



Such was the state of things when the Rev. Edmund Cartwright, of Doncaster, turned his attention to the subject, and contrived a machine for combing wool,—for which he took his first patent in 1790, and a second in the same year; but it was not till nearly two years afterwards that his machine was brought to what he called—“its state of simplicity and perfection;” and for this he took a third patent, in May, 1792. Concerning the latter, he says:—“This machine is, I believe, the first of the kind,—at least, all former attempts (if there have been any) must have proved abortive; as, previous to my invention, no wool was ever known to have been combed any other way than by the slow and expensive process of hand labour.”

The magnitude of this invention, in respect of its object and its importance to the woollen manufacturers, may, in some degree, be estimated by the quantity of combing wool annually grown in this island,—which, according to the most approved calculations, cannot be less than 300,000 or 400,000 packs; the average expense of combing which, by hand, may reasonably be laid at £800,000 or £1,000,000. To shew that this calculation is not far from the truth, it need only be recollected that the body of wool-combers is supposed to be nearly 50,000,—among whom, the alarm which the introduction of this machine occasioned, is well known. Upwards of 40 petitions (from various parts of the kingdom), were presented to Parliament, during the course of the session, for its suppression; and for this purpose a bill was brought into the House of Commons by the friends of the petitioners: it was, however, thrown out, by a great majority. Indeed, had the principle of the bill been admitted, there would have been an end to all manufacturing improvements: but, setting even this consideration aside, on other principles of policy it would have been inadmissible; and, even on the principle of humanity to the petitioners—the only ground on which it could be defended—there is reason to believe it would not have been necessary; the introduction of new inventions or improvements (whatever may be their value) being in general so gradual as to affect those whose occupations they interfere with almost imperceptibly.

This machine consisted of a contrivance termed a cranked lasher, intended to supersede the man's arm and hand in lashing the wool into a circular comb. The material was drawn through a tube, formed into a slightly-twisted sliver, and drawn forward by delivering-rollers.

When two or more slivers were required, the cans or baskets containing them were placed upon a table under the lasher, which, by having a slow motion, twisted the slivers together as they went up.

Above a circular comb-table—which had its teeth pointing towards the centre, and was driven by cogs upon the rim—worked a circular clearing-comb, carried in a frame by two cranks. The

wool was taken from the circular comb-table by a pair of drawing-off rollers, and conducted by a pair of calender-rollers to a can or other receptacle.

It is a singular fact, that although Cartwright patented another machine, in which considerable improvements were introduced, yet he did not perceive the great evil which existed not only in his own machines, but also in the mode of treating the wool by the hand-comber; and although a great number of patents have been taken out for improvements in machinery for combing wool, from the time of Cartwright to the present period, yet all of them, up to the year 1846, continued to overlook the fact that, in the process of combing, the majority of the fibres were broken in two,—producing not only much “noil” or waste,—but considerably shortening the otherwise long fibre: and although they had the practice of the hand flax-dresser, as well as the improved machines for heckling or combing flax, before their eyes, yet they did not discover or attempt any means to remedy this serious defect.

This was the state of things when, in 1846, Josué Heilmann, of Mulhausen, introduced his improved machine “for the purpose of combing cotton, as well as wool and other fibrous materials; into which machine the fibres, as they come from the dressing-machine, are introduced, in the form of a lap, sliver, or fleece, which is broken asunder, and the fibres are combed at each end; and the long and short fibres are separated,—the long ones being united in one sliver—the short ones in another; and they are passed out of the machine, thus separated, ready for drawing, roving, and other subsequent operations.”

The object of Heilmann’s machine is to avoid the old and injurious process of “lashing” the fibres round the teeth or pins of the combs; and the contrivance to effect this object is as follows:—The end of a sliver of uncombed wool is delivered into the machine; and the front end of this sliver is combed by pins fixed on one portion of the surface of a revolving cylinder; whilst the entire mass of the sliver is held tight between a pair of holding nippers. After these rotating pins have combed out the short fibres and other refuse from the sliver, the holding-nippers open; and, at the same moment, a reciprocating comb advances, and pierces through the sliver. A drawing-roller, coming at the same time into contact with a fluted portion of the revolving cylinder, lays hold of the front portion of the fibres (which have been combed), and draws the uncombed portion through a fixed comb and the reciprocating comb before mentioned; and thus effects a combing of the tail-end of the portion of the sliver, which is thereby detached.

The machine is then made to pass another portion of the sliver forward by the action of a cam, which draws back the nippers towards the fixed comb, when the nippers are closed and moved down; and the cam, having again passed into the first position,

causes the nippers to draw forward another length of the sliver. The entire process being repeated with the succeeding length of fibre, another portion is combed and detached, and is carried forward by the drawing-roller, and pieced on to the preceding portion. The combed wool leaves the machine in a continuous sliver,—passing through calender-rollers into a can, from which it is taken to undergo the processes of drawing and spinning. The pins on the revolving cylinder are cleaned by a revolving brush; and the short fibres and refuse are delivered and struck into the teeth of a revolving card roller, from whence they are doffed. Thus, in this way the fibres are combed and laid parallel by the side of each other without being broken: and to such perfection has this machine been brought, that not only some kinds of wool which could not be combed by machinery prior to Heilmann's invention, but cotton, silk, and tow are now undergoing this new mode of treatment, with decided advantage and complete success. Besides, this machine can be so constructed as to take out different lengths of fibre from one sample of material. During the first operation it selects all the longest fibres, which are the most valuable: the remainder are then put through the next machine, which has the nippers and rollers placed closer together, and a second and shorter class of fibres is combed and selected. When again submitted to a third operation, the shortest length is selected; and the remainder is nothing but noil or waste. Such is the character of this beautiful invention, which is well deserving of consideration; and it may be observed that this machine is now being introduced into the Manchester cotton-mills, where the higher classes of numbers are spun.

Mr. Fothergill exhibited a series of specimens, from France, and Yorkshire, of cotton, flax, and silk,—illustrating the process of combing, and the various degrees of fineness in quality that could be produced; and shewed the effect of looping the material over the teeth of the comb and breaking the fibres, as in the old process of combing; and the superior result of drawing out the long fibres unbroken, by the improved process of Heilmann, described in the paper. He stated that previously nothing further could be done with the refuse tow left from combing flax, beyond carding and spinning it into a coarser class of yarn; but, by the improved process, as great a value could be obtained from that refuse by additional combing as was obtained from the first combing by the old process.

---

The following paper, by Mr. WILLIAM FAIRBAIRN, of Manchester, was then read:—

*On the Retardation and Stoppage of Railway-trains.*

The general principle of railway-carriage brakes, namely, that of retarding or stopping the revolution of the wheels by the pressure of brake-blocks against their peripheries, is limited in its

application to the single carriage in which the power is applied by the guard's hand; and looking at the present greatly increased velocities of trains, and their probable acceleration, it becomes a very important question, whether some more powerful and speedy control is not required over the motion of the train than can be obtained by the ordinary plan of a brake upon one or two guards' vans, and upon the tender.

Many plans have been proposed, during the progress of the railway system, for the accomplishment of this desirable object; and amongst them may be mentioned, as one of the most practical, a plan invented some years since by Mr. Robert Heath, of Moss-side, near Manchester, which consisted of brake-blocks fixed in slide-bars in each carriage, and worked by a lever with a weight upon the end of it, adjusted to give the requisite pressure upon the wheels. When the pressure of the brakes was required to be taken off, the ends of the levers were lifted by means of a tension-bar and chains, which extended the whole length of the train, and were worked by a rack and pinion within reach of the guard. The peculiar feature in this brake, distinguishing it from the ordinary hand-brakes, was the employment of a weight to put on the pressure of the brakes, independently of the power of the man's hand, and simultaneously in every carriage of the train,—giving an important advantage in the great increase of power available for stopping the train, and the promptness of its action; the guard having only to release a catch in order to put on all the brakes at once, and employing his own power only in lifting off the brakes afterwards, by means of the rod and chain communicating with each carriage. In a practical trial of these brakes, in 1848, with a train of five carriages and a van, all fitted with the brakes acting together, and the tender-brake also used, the following results appear to have been obtained:—

Speed of Train when Brakes were applied.	Descending gradient.	Distance run after Brakes were applied.
40 miles per hour.	1 in 100	148 yards.
45   "   "	1 in 100	163   "
50   "   "	1 in 82	232   "
55   "   "	1 in 200	264   "

Numerous other plans have been suggested, and tried at different times, for the purpose of arresting the motion of railway-trains within shorter distances than can be effected by the ordinary hand-brakes; but none of them appear to have answered the purpose satisfactorily, or effected any material change in the brakes in general use.

The next improvement requiring particular notice, is the brake recently invented by Mr. James Newall, of Bury,—the more immediate subject of the present paper.

The immense extension of railway communication, and the number of persons conveyed, involve considerations of such vast importance, as to render any attempt to obtain increased security a subject of deep interest, in whatever form or direction that security can be effected. If the causes of the railway accidents which from time to time take place are considered, they may, in many instances, be traced to the inability to bring a train from a state of motion to a state of rest; or, in other words, to the inability to absorb the momentum of the train within a given distance of space, without injury to the carriages, or endangering the safety of the passengers. This has always been a defect in railway travelling, and many of the serious accidents arising from collisions have occurred, from the want of power to stop the train in motion before it arrived at the point of contact.

This, to some extent, has been accomplished by Mr. Newall's brake; and from the results of the experiments made on the East Lancashire railway, on the 7th of November last, as described subsequently, this brake appears to bid fair to accomplish that object, or at all events to become the precursor of further improvements, giving increased security to railway travelling.

The paper contained a detailed account of Mr. Newall's apparatus; but his specification having recently appeared in this Journal (vol. 44, p. 31,) we have thought it unnecessary to repeat this description.

The following are the objects obtained by this brake:—  
1st. A direct communication between the engine-driver and the guard; which communication is always available by either party, in the event of a sudden and unexpected discovery of danger, or obstruction upon the line: this is accomplished, not by ringing a bell or blowing a whistle, where time is lost before the brake can be applied, but by an instantaneous application of the brake itself, or rather, the whole of the brakes, which in every case is the first intimation of the presence of danger, and the remedy to avert its occurrence. This appears to be an important feature in the plan: it is easy of application, and probably the best signal that can be made between two officers of such responsibility as the driver and guard. In the experimental trial of this brake, this was an important feature, and one that could not be mistaken at the moment the brakes were liberated. The check (it could not be called a shock) was so distinctly felt, as to arouse the attention of less vigilant persons than guards and drivers, who are, or should be, constantly on the look out. 2nd. The instantaneous and simultaneous application of the brake to every carriage in the train, and the immediate application of a retarding power to a body of such magnitude as a train in motion, and that without endangering its security, is an advantage of great importance in this plan. The brakes are not screwed against the peripheries of the wheels, as is done in the usual way by the guard in the carriages, and the fireman on the tender; but the whole of the

brakes (even if 30 in number) are dropped at once upon the wheels, and, by the expanding force of the springs in the vertical tubes, the effect is such as to act as a signal from the driver to the guard, or, *vice versa*, from him to the driver. No time, therefore, is lost; and the retarding force is in operation upon every carriage at one and the same time; and, by this operation, a few seconds only are required to reduce the velocity and absorb a considerable portion of the momentum of the train. This simultaneous action is therefore of the utmost importance, particularly in the event of a threatened collision, which by this means, if not totally averted, will assuredly be greatly mitigated in its effects. 3rd. The power which either the engine-driver or the guard have, together or separately, to sledge the train, or to increase or diminish the pressure on the brakes. In applying this plan of brakes to a railway train, particular care is required, in the first instance, when the train is marshalled, to regulate and adjust the brakes upon each carriage, so as to give neither more nor less than the required pressure. This it will be observed is a constant quantity; and the remaining pressure, when required, must be applied by the driver or guard; and as time is an element in this application, there is the less danger of its being injuriously applied, even when extended to the limit of sledging the train, or stopping all the wheels. This power of application is, however, necessary, as the same amount of friction could not be applied with security to the train by the force of the spring, without incurring risk in the breakage of the wheels or axles.

The following are the particulars of the experiments made upon the East Lancashire Railway, to ascertain the retarding power of Mr. Newall's brake, in stopping railway trains: the train in each case consisting of 10 carriages, besides the engine and tender, with a gross weight of 88 tons, including the engine and tender.

No. of Experiment.	Descending Gradient.	Speed of Train when Brakes were applied.	Distance run after Brakes were applied.	Remarks.
1	1 in 532	38 miles per hour	218 yards	Rails moist & slippery
2	Level	33 " "	100 "	Bury, rather doubtful
3	1 in 38	45 " "	430 "	Accrington Incline
4	1 in 40	48 " "	371 "	Ditto ditto
5	Level	48 " "	192 "	Blackburn, 2 wheels
6	Level	40 " "	138 "	Ditto, 5 ditto sledged
7	Level	50 " "	310 "	Ditto
8	Level	42 " "	620 "	{ Blackburn, 3 wheels sledged
9	Level	40 " "	800 "	Ditto

The experiments 1 to 7, were made with eight of the carriages in the train fitted with Newall's brake, besides the ordinary tender brake; and the experiments 8 and 9, were made with ordinary brakes,—two carriages being fitted with them in No. 8, and one in No. 9.

In the experiments 5 to 9, more particular care was taken to ascertain the speed by time and distance; and the moment at which the brakes were to be applied was marked more definitely by the explosion of a detonating signal at the point fixed.

The general result of these experiments appears very favorable to Mr. Newall's brake, as to the efficiency of its retarding power compared with those in ordinary use. At 40 miles an hour, upon a level, with the improved brake, the train was brought up in a distance of 138 yards; but with the ordinary brakes, at 42 miles an hour, 620 yards were run over before the train could be stopped: or, in other words, a railway train can be stopped in one-fourth the distance.

Another plan has been proposed by Mr. Samuel Newton, of Stockport, for attaining the same object of putting on the brakes in the train by self-acting means. To accomplish this, a friction-wheel,  $2\frac{1}{2}$  feet in diameter, and 10 inches broad, is fixed on the centre of each axle: this friction wheel is surrounded with an ordinary clamp brake, such as is generally used in connection with cranes, consisting of an expanding steel ring, lined internally with wood. One end of this brake-ring is fixed to the carriage frame, and to the other end is attached the short arm of a lever; so that when the long arm of the lever is raised, the ring is by this motion enlarged a little in diameter, to allow the friction-wheel to revolve within it without being touched. The long arm of the lever from the front axle approaches that from the hind axle, and both meet under the centre of the carriage: here the levers are joined by a bolt with a slide, so that they may rise and fall together. A weight is then attached; the tendency of which is to depress both levers, and to cause their respective short arms to collapse each brake-ring tightly round the friction-wheel, and thus arrest its revolution, and with it that of the axle and wheels. This is proposed to be the arrangement for every carriage; the weight on the levers between each pair of wheels being about 120 lbs. By force of gravity, the brakes will apply themselves; and the power to be exerted must be for the purpose of taking them off. This is proposed to be done by the pull of the engine, by means of a metal rod with joints, which passes under all the carriages in a train, and is placed in connection with the weighted levers. The first end of this rod is to be joined to the tender; and when the engine starts, it will draw out the rod so as to lift up all the levers, and thus release the brakes from the friction-wheels, and keep them clear, so long as the engine continues its tension upon the draw-bar. By this arrangement it is contemplated by the inventor, that, in order to stop the train,

it will simply be necessary to arrest the speed of the engine, and the draw-bar will then slide backwards by the action of the weights, which will at the same time depress the levers and apply the brakes.

In another plan for accomplishing a similar object, recently proposed by Mr. Alfred Molson, of London, the application of the brakes is proposed to be effected by means of a brake-bar sliding longitudinally under each carriage, acting on the levers of the brake-blocks, and projecting at each end of the carriage as far as the buffers, so as to come in contact with the ends of the brake-bars of the adjoining carriages.

On a check being given to the engine, and its speed being retarded, by applying the brake to the tender, the hindmost carriages of the train will press on those preceding them; and the springs of the ordinary buffers giving way, the train will be thereby shortened some inches; while the brake-bar of each carriage remaining of its original length, and resisting the advance of the carriages behind, it will follow that the last two or three carriages will have the brakes put on before even the guard in the van has turned the handle of his brake.

The two latter plans not having been yet tried, except in models, no practical results can be given; and they have been named with the view of bringing under the consideration of the members the important subject of the prevention of collisions of railway trains, by increasing the retarding power of the brakes.

---

## Scientific Adjudication.

QUEEN'S BENCH, WESTMINSTER,

*Before Lord Chief Justice Campbell and a Special Jury.*

June 23rd and 24th, 1854.

HYDE *v.* TRENT.

THIS was an action for the alleged infringement, by the defendant (a cocoa-nut fibre manufacturer, at Old Ford, near Bow), of a patent granted to John Barsham, 26th April, 1849, for "improvements in separating the fibres of cocoa-nut husks,"\* and assigned to the plaintiff. Mr. Edwin James and Mr. Wordsworth appeared for the plaintiff, and Mr. Bramwell and Mr. Russell for the defendant.

From the evidence of Mr. Barsham, the patentee, it appeared that his process of treating the husks of cocoa-nuts, to extract the useful fibre therefrom, was as follows:—The nib ends of the split husk, or outer shell, were first cut off, and then the pieces

\* For specification of this patent, see Vol. 35., p. 333, London Journal.



of shell were passed between crushing-rollers to loosen the fibres, and enable them readily to absorb water. The shells were next soaked in water, and afterwards passed between rollers, to render them ready for carding. The next process was to hold the husk against a sliding rest, set in front of a card-cylinder, and submit it to the action of the card-teeth, for the purpose of taking off the outer coating. The husk was then passed to another machine, to comb out the remainder of the pulp surrounding the fibres. This operation was performed while the fibres were in a damp state. In 1849, the witness discovered the improved mode of operating, as above described; carried on business at Kingston, and manufactured brushes and mattresses;—knew no mode of separating fibre long before the date of his patent. Under a patent, dated 1845, had made cocoa-nut fibre brushes from imported fibres; sold many brushes, but abandoned the manufacture, as the brushes had not sufficient elasticity. Prior to taking his patent of 1849, knew of Logan's patent process for treating cocoa-nut fibre; it was totally different from his own. In 1853, went with the plaintiff to defendant's works, and saw defendant's mode of operating. Trent's combing or carding-cylinders were larger than his; and, instead of the husk being held over a rest, it was held between rollers and carded while damp. He considered the use of rollers of any kind, for crushing the husk while damp, an infringement of his patent: the damping rendered the fibres less brittle. The difference of value between the fibre obtained in his way and that of former manufactures, is 10*d.* per lb.

Mr. Carpmael examined. Knew Barsham's specification; prepared it, and also Logan's (dated November, 1841); believed there was no fibre, like Barsham's, obtained before his patent. Logan's process would give a mixture of long and short fibres: considered the plaintiff's patent to consist in subjecting the shells, in the wet and crushed state, repeatedly, to revolving combs,—retaining back the strong and straight fibres; had seen defendant's mode of working, who steams the husks, passes them between crushing-rollers, and then presents them to the action of a rotary comb: the carding cylinders of the defendant's and plaintiff's are equivalents: the novelty of plaintiff's process is the adaptation of old machinery to a new use.

Other witnesses were called to prove the novelty of manufacturing brushes from long cocoa-nut fibre.

The defence set up was, that the plaintiff's mode of obtaining cocoa-nut fibre was not a new manufacture; but, that prior to the date of plaintiff's patent, crushing-rollers for partially separating the fibres of cocoa-nut husks, and apparatus having revolving surfaces, with spikes or teeth for combing out the fibres, was used by defendant at Old Ford, Bow; by John Oatley, of Shadwell; by Messrs. Stringer & Romsey, of Broad Bridge, Dean-street, Shadwell; and by Messrs. Logan & Treloar, of Ludgate Hill.

In support of this defence, Mr. Trent gave evidence that while

in the employ of Mr. John Smith, of Old Ford, the idea of manufacturing cocoa-nut fibre was suggested to him by Messrs. Stringer & Romsey, who had formerly carried on that business. In 1846, defendant fitted up crushing-rollers to operate on the damped shell; and an old rag-breaking machine or devil to comb out the pulp from between the fibres. Set them in operation early in 1847. He first wetted the husks and passed them between the crushing-rollers three or four times; then held them up to the combing cylinder, and drew them back. If long fibre was required, he turned the nut, to comb both ends, and retained hold of the fibre; but for curling fibre, he passed the fibres through the machine. Carried on the manufacture until the second or third month of 1848, and then gave it up; and did not again resume it until he left Smith's service in 1852. Supplied Mr. Treloar with one ton of fibre for mattresses; but did not sell much long fibre,—brush makers being averse to using it. When he gave up the business, sold the machinery to Smith.

Mr. J. Smith examined.—Prevailed on defendant to stay in his service and give up the cocoa-nut fibre business; bought defendant's machinery: when defendant left his service, sold him the rollers at present used for crushing the husks.

Mr. Enderby identified the rollers as those purchased by him of a Mr. Sharp, and made under his patent of 1837, for treating hemp, and subsequently sold to Smith.

Capt. Logan examined.—Had made long fibre from cocoa-nut, under his patent of 1841. His process was to soak the husk, chop off the ends, and pass the husks between crushing-rollers: combed the fibre by the use of common devilling machinery precisely like defendant's; held the husk to the devil, to comb it, in 1842; did not continue working it for more than two years; found a market for long fibre, but did not pursue this branch.

Mr. Treloar, partner of Capt. Logan, confirmed his statements; and proved that he purchased cocoa-nut fibre of defendant. Mr. Romsey and Mr. Oakley also proved, that prior to plaintiff's patent, they had manufactured cocoa-nut fibre in the manner pursued by the defendant.

Mr. Edwin James, in his reply, called the attention of the jury to the fact that the defendant had not proved the use of long fibre for making brushes prior to the date of the plaintiff's patent; and failing that, his evidence went to shew that long fibre had only been made experimentally; and that the plaintiff was the first to introduce it to the only purpose to which it could, with special advantage, be applied.

The learned Judge, at this stage of the proceedings, proposed an adjournment; but the jury, having intimated that they required his Lordship's remarks only upon a few points, to enable them to give their verdict, his Lordship thereupon summed up, very briefly,—laying down the law that the use of the crushing-rollers had been anticipated by Sharp's patent for crushing

hemp; and that no claim for their application to the crushing of cocoa-nut husks would hold. The jury, having considered their verdict, and agreeing, with but one dissentient, a discussion took place in open court, from which it appeared that the majority of the jurors had arrived at the belief that the patent under consideration was for the manufacture of brushes, instead of for obtaining cocoa-nut fibre. Upon this, his Lordship adjourned the cause; and, on the opening of the court on the following morning, summed up the evidence more fully; when the jury gave a verdict maintaining the patent, but denying its infringement by the defendant.

---



---

LIST OF GRANTS OF PROVISIONAL PROTECTION.

[*Cases in which a full Specification has been deposited.*]

1458. Alexander Southwood Stocker, of Hall-street, City-road, for certain improvements appertaining to match-boxes, and in the fitting, stoppering, and covering of tubes and other vessels of glass, porcelain, and other materials.—[*Dated July 4th.*]  
 1513. Paul François Aerts, of Brussels, for improvements in constructing parts of railway rolling stock and in the lubrication thereof.  
 1515. Thomas Frederick Henley, of Brompton, for improvements in the preparation of certain colouring materials.

*The above bear date July 11th.*

1520. William Bessie, of Gloucester, for improvements in trucks used on railways.—[*Dated July 12th.*]

[*Cases in which a Provisional Specification has been deposited.*]

77. Joseph Serf, of Paris, for improvements in seats, or chairs for advertising.—[*Dated January 12th.*]  
 835. Louis Marie Trouble, of Paris, for certain improvements in stamping apparatus (or autoperitype).—[*Dated April 10th.*]  
 874. Charles Brutus Goodrick, of Old Kent-road, for an improved artisan's tool, which may be used as a measuring rule, straight-edge, set square, T square, bevil, and plumb rule.—[*Dated April 15th.*]  
 979. Thomas Jackson, of Commercial-road, Pimlico, for improvements in the manufacture of paper from flax, hemp, jute, Indian grass, and other fibrous vegetable substances, or the tow produced from such fibrous substances.—[*Dated May 2nd.*]  
 1041. James Ward Hoby, of Renfrew, and John Milner, of Stanley-street, Pimlico, for certain improvements in steam engines.—[*Dated May 10th.*]  
 1049. Henry Tylor, of Queen-street, London, for an improvement in chair bedsteads.—[*Dated May 11th.*]

1194. Auguste Edouard Loradoux Belford, of Castle-street, for improvements in machinery for making bags of paper or other suitable material,—being a communication.
1200. Hall Colby, of New York, for improvements in instruments for taking altitudes, levels, and angles; which he designates “Colby’s Altimeter,” or “self-adjusting quadrant or sextant.”
1201. Edward Loysel, of Rue de Grétry, Paris, for improvements in grinding or pulverizing vegetable substances, and in obtaining infusions or extracts from tea.

*The above bear date May 30th.*

1202. John McFarlane, of Renfrew, for improvements in steam-boilers.
1203. Thomas Harrison and Elisha Harrison, both of Blackburn, for improvements in looms for weaving.
1204. John Kent, of St. James’s-square, Notting-hill, for improvements in harbour and river boats and other floating vessels, also in paddle-box boats.
1205. George Alfred de Penning, of Calcutta, for an appendage to screw propellers.
1206. William Edward Wiley and Edward Lavender, both of Birmingham, for improvements in the manufacture of certain kinds of metallic pens.
1207. Abraham Rogers, of Beeston Royds, near Leeds, for improvements in the mode of ventilating mines, sewers, and other subterranean works; and likewise for the warming and ventilating of all kinds of public buildings.
1208. Charles Claude Etienne Minié, of Paris, for improvements in projectiles.
1210. Léon Isidore Molinos and Charles Pronnier, both of Paris, for improvements in locomotive steam-engines.
1211. Alfred Vincent Newton, of the Office for Patents, 66, Chancery-lane, for an improved mode of manufacturing soluble silicates,—being a communication.

*The above bear date May 31st.*

1212. David Duncan, of Oak Foundry, Crofton, Yorkshire, for improvements in railway points or switches and crossings.
1213. John Whitaker and James Pickles, both of Todmorden, Yorkshire, for improvements in machinery or apparatus for opening, cleaning, and preparing cotton, wool, or other fibrous substances.
1214. John Arrowsmith, of Bilston, for improvements in steam-boilers.
1215. Charles King and Edward Sutton Benfield, both of Chemies-street, for improved machinery for cutting and carving wood, stone, and other materials.
1216. Walter Westrup, of Old Ford, for improvements in the manufacture of wheat into flour.

1217. James Timmins Chance, of the Glass Works, near Birmingham, for improvements in machinery for roughing or preparing the surfaces of glass,—being a communication.
1218. Stephen Schwabe, of Manchester, for making sulphate of soda or Glauber's salts,—being a communication.
1219. Joseph Robinson, of Denton Mill, Carlisle, for improvements in apparatus for mixing wheat and other grain and matters.
1220. Owen Rowland, of Lloyd-square, for an improved apparatus for damping papers, labels, and other like articles.
1221. George Kenedy Geyelin, of Camden-town, for improvements in furnaces and fire-places for facilitating the consumption of smoke.

*The above bear date June 1st.*

1222. Thomas Greenshields, of George-street, Derby, for improvements in railway chairs.
1223. Charles Maschwitz, of Birmingham, for a new or improved instrument for paring and slicing apples, potatoes, and other fruits and roots,—being a communication.
1224. Benjamin O'Neale Stratford, Earl of Aldborough, of Stratford Lodge, Wicklow, for improvements in locomotion on land and water; part or parts of which are applicable to the raising of weights and the working of machinery.
1225. Edward Orange Wildman Whitehouse, of Brighton, for improvements in effecting telegraphic communications.
1226. Moses Poole, of the Avenue-road, Regent's-park, for an improvement in cop-tubes, for mule and other spindles, and machinery for making such cop-tubes,—being a communication.
1227. Egmont Websky, of Wustewaltersdorf, Prussia, for improvements in bleaching,—being partly a communication.
1228. Isaac Taylor, of Stanford Rivers, Essex, for an improvement in producing thin metallic shells, adapted to printing.
1229. John Mason and Louis Christian Koeffler, both of Rochdale, for improvements in scouring, and in washing wool, hairs, and yarns, and in machinery or apparatus for effecting the same.
1230. William Wilkinson, of Nottingham, for improvements in stamping, raising, or printing patterns upon leather, textile thread, cut-pile, or other similar fabrics; and also for dressing textile, cut-pile, and other similar fabrics, previous to the stamping and printing.

*The above bear date June 2nd.*

1231. Peter Armand le Comte de Fontainemoreau, of South-street, for an improved fuel,—being a communication.
1232. Peter Armand Le Comte de Fontainemoreau, of South-street, for improvements in the construction of umbrellas and parasols,—being a communication.
1233. Thomas Lenox, of Pigott-street, Limehouse, for a novel mode of reefing topsails, jibs, and other sails, from the decks of ships whilst at sea.

1234. Peter Armand Le Comte de Fontainemoreau, of South-street, for improvements in producing a useful substitute for leather in various applications,—being a communication.
1235. Absalon Hippolyte Leplay, of Douvrin, Pas de Calais, for certain improvements in extracting and manufacturing the alcohol of beet-root, and of other sweet matters or tubers.
1237. William Edward Newton, of the Office for Patents, 66, Chancery-lane, for improvements in breech-loading fire-arms,—being a communication.
1238. John Samuel Foretier, of Carlton Hill, for improvements in railway brakes, and in machinery connected therewith,—being a communication.
1239. Abel Franklin Goodnow, of the State of New York, for an improvement in scythe-snaths, or the manufacture thereof,—being a communication.
1240. Antoine Chavanes, of Rupert-street, Haymarket, for improvements in apparatus for indicating the time a public carriage is, and is not, engaged for hire,—being a communication.
1241. Alfred Garratt Barham, of Bridgewater, for an apparatus for damping or moistening the adhesive surfaces of stamps or labels.

*The above bear date June 3rd.*

1242. James Bowman Lindsay, of Dundee, for a mode of transmitting telegraphic messages by means of electricity through and across a body or bodies of water.
1243. Richard Archibald Brooman, of Fleet-street, for an improvement in screw-propellers,—being a communication.
1244. Walter Crum and Peter Stewart, both of Thornliebank, Renfrew, for improvements in machinery and apparatus for beetling or finishing woven fabrics.
1245. George Garbert, of Port Louis, Mauritius, for improvements in the construction of buildings.
1246. Hippolyte Bordier, of Orleans, for improvements in the manufacture of alcohol,—being a communication.
1247. Napoléon Néron, of Rue St. Lazare, Paris, for improvements in muskets, carbines, fowling-pieces, and other fire-arms,—being a communication.
1248. Edward Maniere, of Bedford-row, for improvements in getting peat and in manufacturing peat with other matters into fuel,—being a communication.
1249. Andrew Spottiswoode, of New-street, St. Bride's, for improvements in the manufacture of fuel.
1251. Thomas Spiller, of Red Lion-square, for improvements in propelling carriages when atmospheric air is used.
1252. Somerville Scott Alison, of Park-street, Grosvenor-square, for the manufacture of a new material to be used for external applications in medicine.

*The above bear date June 5th.*

1253. William James Baillie, of Southwark, for an improved mode of propelling ships and other floating vessels.
1254. William Thomas Parkes, of Aston-juxta-Birmingham, for an improvement or improvements in the manufacture of the ornamental parts of gas fittings.
1255. John Nicholson, of Blackwall, for an improved ratchet screwing and drilling stock, which may also be used as a spanner.
1256. David Atkinson, of Seaham Harbour, Durham, for improvements in printing, and in the machinery or apparatus to be employed therein or connected therewith.

*The above bear date June 6th.*

1258. John Mansfield, of Stoke, Staffordshire, for an improvement or improvements in steam-boilers.
1259. Charles Anthony Perpigna, of Paris, for improved apparatus for effecting the combustion of smoke in fire-places,—being a communication.
1260. William Edward Newton, of the Office for Patents, 66, Chancery-lane, for an improved manufacture of bonnets and other coverings for the head,—being a communication.
1261. Peter Hindle, of Ramsbottom, Lancashire, for certain improvements in power looms for weaving.

*The above bear date June 7th.*

1262. John Wilson, of Albert-place, Stratford, for an improved pump, applicable to mines, wells, ships, fountains, and domestic purposes, and raising melted metals in foundries; so constructed that it cannot lose water, draw grit, draw air, or freeze.
1263. Joseph Kaye, of Beeston, near Leeds, for certain improvements in machinery or apparatus for slubbing, roving, spinning, and doubling wool, and other fibrous materials.
1264. William Alldritt, of Belfast, for improvements in lighting and ventilating.
1265. Michael Scott, of Great George-street, Westminster, for improvements in roofing or covering reservoirs or holders for liquids.
1266. James Leadbetter, William Wight, and Thomas Davis, all of Halifax, Yorkshire, for improvements in machinery or apparatus for raising water and other fluids.
1267. Joseph Skertchly, jun., of Kingsland, for improvements in the manufacture of gates, hurdles, and fencing; in vehicles, waggons, carts, and trucks, for common roads and railways, and in facias, entablatures, window headings, parapet and other mouldings, projecting from the brick-work of buildings.
1268. Pierre Journet, of Rue de Belzunce, Paris, for improvements in chucks for lathes.
1269. Bewicke Blackburn, of Clapham Common, for improvements in the manufacture of pipes, when applying slate for such purpose.

1270. Thomas Richardson, of Newcastle-on-Tyne, for improvements in the manufacture of alum.

*The above bear date June 8th.*

1271. Jean Baptiste Numa Erard, of Paris, for improvements in the preparation of paint.
1272. Frédéric Margueritte, of Paris, for improvements in wet gas-meters.
1273. Richard Archibald Brooman, of Fleet-street, for improvements in machinery for cutting brads, lath nails, and others of similar character,—being a communication.
1274. Thomas Bramwell, of Enfield House, near Gateshead-on-Tyne, for improvements in the manufacture of the carbonates and prussiates of potash and soda.
1275. John Nelson, of Selby, and David Boyd, of the same place, for improvements in preparing and scutching flax, hemp, and other substances.
1276. James Lamb Hancock, of Neath, for an improvement in cutting hay, straw, and other fibrous articles and substances.
1277. John Currie and Robert Young, both of Glasgow, for improvements in the treatment and grinding of grain and the products thereof.
1278. Benjamin Cook, of Birmingham, for certain improved means of ornamenting metallic bedsteads, chairs, and couches; which said improvement is also applicable for ornamenting standards for glass frames, tables, and fire-screens, cornice poles, and other articles of furniture.
1280. Gustav Adolph Buchholz, of Hammersmith, for improved machinery applicable to the hulling or cleaning of grain, seeds, and other vegetable produce.

*The above bear date June 9th.*

1282. Arthur Llewellyn Dawson, of Southwark-bridge-road, for improvements in machinery for cutting and shaping wood.
1283. Andrew Barclay and John Barclay, both of Kilmarnock, for improvements in printing textile fabrics and other surfaces.
1284. Louis Bois, of Paris, for certain improvements in looms.
1285. John Whitehead, of Preston, for a machine for weaving wire netting of iron, brass, or other material,—being a communication.
1286. Edwin Powley Alexander, of Lincoln's-inn-fields, for improvements in moulding,—being a communication.
1287. Francis Puls, of Whitechapel-road, for improvements in electro-galvanic apparatus for medical purposes; parts of which improvements are also applicable to other electro-galvanic apparatus.

*The above bear date June 10th.*

1288. John Young, of Wolverhampton, for improvements in locks and latches.



1289. Richard Archibald Brooman, of Fleet-street, for a method of producing plans in relievo,—being a communication.

1290. Richard Archibald Brooman, of Fleet-street, for an improvement in, or addition to, sugar basins,—being a communication.

*The above bear date June 12th.*

1291. Antoine Louis Péter, of Lyons, for improvements in treating a certain kind of indigo.

1292. Charles Henry Compton, of Bloomsbury, for an improved railway break.

1293. William Southall, of Swan-lane, for improvements in machinery or apparatus for cultivating and pulverizing land.

*The above bear date June 13th.*

1294. James Barlow, of Accrington, for improvements in the mode or method of extracting gluten and preparing the same for sizing purposes.

1295. James Pickup, of Liverpool, for improvements in steering apparatus.

1296. John Hargrave, of Kirkstall, York, for improved machinery for washing, scouring, and felting or fulling.

*The above bear date June 14th.*

1297. Joseph Edwards, of Camberwell, for an improved knife cleaner.

1298. Frederic Martini, of Elberfeld, Prussia, for an improvement in working steam-engines.

1299. Thomas Wilson, and John Hadley, both of Birmingham, for a new or improved method of constructing certain kinds of rolls or cylinders and dies or surfaces.

1300. James Kite (Secundus), of Princes-street, Lambeth, for improvements in machinery and apparatus for expressing moisture from substances.

1301. John Gedge, of Wellington-street South, Strand, for improvements in the construction of locks and latches, spindles and knobs, applicable to doors and other similar purposes.

1302. Samuel Varley, of Stamford, Lincolnshire, for an improved construction of hay-making machine.

1303. John Davie Morries Stirling, of Blackgrange, Clackmannon, Scotland, for improvements in the manufacture of iron,—being partly a communication.

*The above bear date June 15th.*

1304. John Edwin Piper, of New-road, St. Pancras, for improvements in the preparation of linen, cotton, and other fabrics, to produce a factitious leather.

1305. William Brindley, of Moorgate-street, for improvements in applying steam for offensive and defensive purposes.

1306. Richard Hornsby, of Spittlegate Iron Works, Grantham, for improvements in portable thrashing machines.

1307. Thomas Mara Fell, of King William-street, and William Cooke, of Curzon-street, Hanover-square, for improvements in ventilators.
1308. William Cooke, of Curzon-street, Hanover-square, for improvements to boots and shoes.
1309. Charles Hargrove, of Birmingham, for an improvement or improvements in the manufacture of certain kinds of iron.
1310. William Evans, of Saint Leonard's-terrace, Chelsea, for an improved tap for drawing off liquids.
1311. Frederic Martini, of Elberfeld, Prussia, for a new and improved construction of steam-engines.
1312. James Macnee, jun., of Glasgow, for improvements in caps, hats, and other coverings for the head.
1313. Frederick John Julyan, of Gerrard-street, Soho-square, for improved methods of producing musical sounds.
1314. William Gilbert Pidduck, of Camberwell, for improvements in the construction of vent-pegs.
1315. Hesketh Hughes, of Alderagate-street, for certain improved machinery for cutting and embossing, either separately or simultaneously.
1316. Thomas Parramore, of Castle-street, Southwark, for an improvement in the manufacture of air-tight seats, beds, and other articles required to be inflated and air-tight.
1317. David Lowe, of Leicester, for improvements in knitting machinery.

*The above bear date June 16th.*

1318. George James Hinde, of Wolverhampton, for a new or improved combination of materials to be used for the manufacture of pipes or tubes for drains, and for such other purposes as the same is or may be applicable to.
1319. Peter Armand Le Comte de Fontainemoreau, of South-street, for improvements in treating bitumen,—being a communication.
1320. John Aspinall, of Tavistock-square, for an improved means of creating a vacuum, or partial vacuum, for evaporative purposes.
1321. Joseph Fourdrinier, of Sherborne-street, Islington, for improvements in machinery for washing, boiling, cleaning, and bleaching rags, fibrous and textile substances.
1322. Alfred Vincent Newton, of the Office for Patents, 66, Chancery-lane, for improvements in machinery for block-printing,—being a communication.
1323. John Rawe, the younger, of Haverstock-hill, for improvements applicable to stoves, stove-grates, or fire-places, for domestic use.
1324. George Holloway, of Stroud, for improvements in sewing and embroidering machines.
1325. John Allin Williams, of Baydon, Wilts, for improvements in machinery or apparatus for ploughing and cultivating land.

1326. Auguste Edouard Loradoux Bellford, of Castle-street, for improvements in water-mill machinery,—being a communication.

*The above bear date June 17th.*

1327. Louis Ambroise Henry, of Metz, France, for certain improvements in constructing railroads.

1329. Sir James Caleb Anderson, of Formoy, Cork, for an economical railway for the conveyance of passengers, goods, and letters.

1330. George Mears, of the Bell Foundry, Whitechapel-road, for improvements in machinery or apparatus for obtaining sound.

1331. John Westlake, of Newton Abbott, for improvements in treating the pulverized solution obtained from machines used for crushing ores, gossans, earths, and rocks.

1332. Joseph Valentin Weber, of Orchard-street, St. Luke's, for improvements applicable to chronometers and other mechanism requiring a steady spring power.

1333. William Bauer, of Munich, for improvements in propelling vessels.

1334. Prosper Guilhaume Dartignenave, of Regent-street, for improvements in aerial navigation.

1335. Joseph William Schlesinger, of London-wall, for a means of readily discovering any street, road, river, locality, or place, on maps, charts, and plans,—being a communication.

1336. Samuel Riley, of Oldham, for certain improvements in pocket-books, bill-cases, or other such depositories.

1337. Joseph Oliver, of Wapping, for an improved construction of signal lantern.

1338. David Bogue, of Fleet-street, for an improved apparatus for facilitating the attachment of adhesive stamps,—being a communication.

*The above bear date June 19th.*

1339. Henry Worrall, of Staley Bridge, for improvements in machinery or apparatus for carding cotton, wool, or other fibrous materials.

1340. William Brunton, of Camborne, Cornwall, for certain improvements in metallic pistons.

1341. James Acland, of Langley Cottage, South Lambeth, for improvements in the manufacture of paper.

1342. Thomas Littleton Holt, of Warwick-square, and William Charlton Forster, of Hatton Garden, for making paper.

1343. Charles Reeves, of Birmingham, and William Wells, of Sutton Coldfield, for a new or improved method of manufacturing certain kinds of metallic tubes.

1344. Joseph Day, of Birmingham, for an improvement or improvements in certain kinds of candlesticks.

1345. Alexander Stephen, and Alexander Pirnie, both of Kelvinside, near Glasgow, for certain improvements in the application of materials for and in the arrangement of and method of applying apparatus, to be used as templates for ascertaining and marking the proper positions for the rivet and bolt-holes required in the plates, frames, and other pieces or portions of the materials used in the construction or manufacture of iron ships or vessels, boilers, tanks, masts, spars, and other similar articles.
1346. Jean Eugène Jesson, of Paris, for an improved barometer, called "hydrographer barometer."
1347. Nathaniel Clayton and Joseph Shuttleworth, of Stamp End Iron Works, Lincoln, for improvements in portable and fixed combined thrashing, shaking, and winnowing machines.
1348. Willoughby Theobald Monzani, of St. James' terrace, Bermondsey, for an improvement in brushes and brooms.
1350. Frederick Braithwaite, of Gower-street, for improvements in constructing suspension bridges, roofs, and coverings.
1351. George R. Chittenden, of Wood-street, for improvements in sewing-machines,—being a communication.
1352. Alexander Mc Laine, jun., of Belfast, for an improved mode of constructing and fitting gun-boats.
1353. William Edward Newton, of the Office for Patents, 66, Chancery-lane, for an improved manufacture of pigments or coloring matters,—being a communication.
1354. George Henry Byerley, of Paris, for improvements in machinery for the manufacture of bricks, tiles, quarries, tubes, and other such like articles.

*The above bear date June 20th.*

1355. William Donald and William Heginbotham, both of Carlisle, for certain improvements in looms.
1356. John Mc Innis, of Liverpool, for an improved composition for coating the bottoms of iron ships, to prevent their fouling, and other useful purposes.
1357. Henry Vernon Physick, of North-bank, Regent's-park, for electric telegraphs, and apparatus connected therewith.
1358. Henry Dembinski, of Rue Joubert, Paris, for improvements in heating apparatus.
1359. Oliver Rice Chase, of Cornhill, for improvements in machinery for manufacturing lozenges and for other purposes.
1360. James Whitworth Shaw, of Birmingham, for improvements in apparatus or machinery for producing motive power,—being a communication.
1361. William Edward Newton, of the Office for Patents, 66, Chancery-lane, for improvements in apparatus for generating and utilizing steam,—being a communication.
1362. Thomas Rhoads, of Vine-street, America-square, for an improved method of framing school slates,—being a communication.

1363. William Stableford, of the Bromsgrove Railway Carriage Works, for improvements in railway brakes.
1364. William Parsons, of Paradise-street, Lambeth, for improvements in rotatory engines.
1365. John Fry Heather, of the Royal Military Academy, Woolwich, for improvements in apparatus for regulating the flow of gas.

*The above bear date June 21st.*

1366. William Stidolph, of Wintoun-place, Greenwich, for a transferable book-marker.
1367. Thomas Chadwick Yates, of Bolton-le-Moors, for improvements in wickets for the game of cricket.
1368. George Simpson, of Union-buildings, Leather-lane, Holborn, for improvements in furnaces.
1369. John Marriott Blashfield, of Millwall, for improvements in the manufacture of china, pottery, bricks, and other articles manufactured for the most part of clay.
1370. William Henry Brown, of Wardsend Steel Works, near Sheffield, for an improvement in the construction of furnaces for the melting of steel and other metals requiring a crucible in the melting thereof.
1371. Charles Cowper, of Southampton-buildings, for improvements in machinery for combing cotton, wool, flax, tow, silk waste, and other fibrous substances,—being a communication.
1372. Auguste Edouard Loradoux Bellford, of Castle-street, for certain new and useful improvements in machinery for forging or hammering iron, which may be also applicable to the hammering of other materials,—being a communication.
1373. Ephraim Smith, of Carlisle-street, for an improved watch-key.
1374. Auguste Edouard Loradoux Bellford, of Castle-street, for certain improvements in grate-bars, and certain appliances to the same, for the purpose of preventing them from warping or twisting by heat,—being a communication.
1375. George Fox Logan, of Glasgow, for improvements in portable winches.
1376. Astley Paston Price, of Margate, for improvements in the treatment of certain alloys of tin.
1377. Astley Paston Price, of Margate, for improvements in the purification of tin, and in obtaining useful products arising from such purification.
1378. Godfrey Ermen, of Manchester, for certain improvements in machinery or apparatus for winding yarns or threads.
1379. Isaac Farrell, of Dublin, for improvements in fireproof flooring and roofing; which improvements are also applicable to the construction of walls and bridges, and other like structures.

*The above bear date June 22nd.*

1380. Charles Phillips, of Offchurch, Warwickshire, for the improvement of apparatus or machinery for reaping.
1381. David Clovis Knab, of Rue Rosini, Paris, for certain improvements in the production of carburets of hydrogen.
1382. Peter Armand Le Comte de Fontainemoreau, of South-street, for improvements in machinery for the manufacture of nails,—being a communication.
1383. Auguste Edouard Loradoux Bellford, of Castle-street, for an improvement in propelling vessels in water,—being a communication.
1384. Salomon Dreyfus-Werth, and Pierre Meunier, of Sainte Marie-aux-mines (Haut Rhin), France, for a new or improved system of applying designs to all kinds of fabrics, and of surfaces of wood, marble, and stone.
1385. Auguste Edouard Loradoux Bellford, of Castle-street, for certain improvements in machinery for picking or opening cotton and other fibrous materials, and all kinds of waste rags and old materials, to prepare the same for the operation of carding, or for other operations,—being a communication.
1386. Thomas Rudd, of Pimlico, for improvements in stands for casks or barrels.
1387. John Wield, of Glasgow, for improvements in preventing the drainage waste of cargoes on ship-board.
1388. John Keyse, of Apollo-buildings, Walworth, for an improved method of loading muskets, rifles, carbines, pistols, and all descriptions of small arms with cartridge, without applying the cartridge to the mouth.
1389. Thomas Isaac Dimsdale, of Hadley, for an improvement in the manufacture of gas for lighting and heating purposes.
1390. William Ellsworth Osborn, of Milton, Ulster, U.S., for improvements in breech-loading guns or cannon.
1391. Richard Garrett, jun., of Leiston Works, near Saxmundham, for an improved arrangement of valves for working steam expansively.
1392. Robert Michael Letchford, of Whitechapel, for a match-stand and holder for holding matches while being ignited.

*The above bear date June 23rd.*

1393. Henry Lightbown, of Pendleton, for improvements in drying pulp in the manufacture of paper, also paper-hangings and printed textile fabrics.
1394. Thomas Skelton, of Plaistow, for an improvement in, or addition to, tillers or yokes.
1395. Richard Archibald Brooman, of Fleet-street, for a new or improved projectile for ordnance and small arms, and a sabot or plug to be employed therewith; which sabot or plug may also be used with other projectiles,—being a communication.
1396. David Lloyd Williams, of Cannon-street, and John William Neale, of Stepney, for improvements in furnaces.

1397. Richard Archibald Brooman, of Fleet-street, for an improved mill for grinding and pulverizing paints and various vegetable and mineral substances,—being a communication.
1398. Joseph Davies, of Bristol, for improvements in propelling vessels.
1399. John Thomson, of Newton-le-Willows, for improvements in centrifugal apparatus used in the manufacture of sugar.
1400. John Kenworthy and Thomas Rigby, both of Preston, for certain improvements in water-closets.
1401. Reuben Bottomley and Henry Spencer, both of Rochdale, and David Schofield, of Oldham, for certain improvements in machinery or apparatus for spinning and doubling cotton and other fibrous materials.
1402. John Revell, of Newark, Nottinghamshire, for improvements in horse-hoes.

*The above bear date June 24th.*

1403. Emile Hubner, of Mulhouse, France, for improvements in machinery for preparing wool, cotton, silk waste, tow, and other fibrous materials.
1404. Alexander Bain, of Queen's-row, Grove-lane, Camberwell, for improvements in fire-arms and the apparatus connected therewith.
1406. James Brown, of Haddington, Scotland, for improvements in the manufacture of metal spouts or troughs.
1407. William Palmer, of Sutton-street, Clerkenwell, for improvements in candle lamps.
1408. Charles Beale and John Latchmore, both of Leicester, for improvements in the manufacture of knitted shirts.
1409. Thomas Hill Bakewell, of Wellford-road, Leicester, for improvements in the manufacture of gloves.
1410. William Yates, of Bromley, Middlesex, for improvements in furnaces.

*The above bear date June 26th.*

1411. William Brindley, jun., of Moorgate-street, for improvements in the construction of life-boats.
1412. Andrew Smith, of Princes-street, for improvements in the manufacture of certain kinds or descriptions of wire and other ropes and strands.
1413. Charles Hastings Collette, of Lincoln's-inn-fields, for improvements in the manufacture of beer,—being a communication.
1415. Richard Leicester Antrobus, of Birmingham, for a new or improved method of printing oil-cloth for floor and table-covers, paper-hangings, and other surfaces.
1416. William Morgan, of Birmingham, for improvements in machines for cutting paper, card and millboards, woollens, veneers, and materials used in making paper; parts of which improvements are applicable to other machines where quick

and slow motions are used, and where machinery is required to be thrown into and out of gear.

1417. Charles Iles, of Peel Works, Birmingham, for improvements in metal bedsteads.
1418. William Coltman, of High-street, Leicester, for an improvement in knitting-frames.
1419. Peter Armand Le Comte de Fontainemoreau, of South-street, for improvements in apparatus for producing aerated waters,—being a communication.

*The above bear date June 27th.*

1420. Peter Armand Le Comte de Fontainemoreau, of South-street, for improvements in the construction of axle-boxes,—being a communication.
1421. James Brunlees, of Manchester, for improvements in draw-bridges, applicable to rail and other roadways.
1422. Henry Sutherland Edwards, of Cranbourne-street, for improvements in preparing textile fabrics or materials for the purpose of their better retaining colors applied to them,—being a communication.
1423. Edmund Cockshutt, of Preston, for improvements in bungs or adjustable stopper apparatus for casks and other vessels.
1424. James Morison, of Paisley, for improvements in the treatment or manufacture of ornamental fabrics.
1425. Theophile Schlœsing, of Paris, for improvements in the manufacture of carbonates of soda.
1426. John Gregory Jones, of Roscommon-street, Liverpool, for improvements in apparatus for teaching addition.

*The above bear date June 28th.*

1427. William John Bisseker, of Birmingham, for a new or improved method of labelling bottles and such other vessels or articles as require or may require labelling.
1428. Corydon Stillman Sperry, of Connecticut, U.S., for an improved knitting machine,—being a communication.
1429. Thomas Markland, of Hyde, Cheshire, for certain improvements in machinery or apparatus for warping, dressing, and weaving textile materials.
1430. William Smith and William Bramwell Hayes, both of Manchester, for certain improvements in power-looms for weaving.

*The above bear date June 29th.*

1431. Edward Joseph Hughes, of Manchester, for improvements in sewing machines,—being a communication.
1432. John Edwards, of Manchester, for improvements in railway chairs.
1433. Daniel Towers Shears, of Bankside, for improvements in curing or separating moisture from sugar and other substances,—being a communication.



1434. Laurent Furcy Izart, of France, for a new mode of removing organic vegetable substances from woollen fabrics.
1435. Willoughby Theobald Monzani, of St. James'-terrace, Bermondsey, for improvements in the manufacture of folding chairs, stools, and other articles to sit or recline upon.
1436. Nathan Thompson, jun., of New York, for improvements in regulating the supply of steam from steam-boilers.
1437. Henry George Gray, of Commercial Wharf, Mile End-road, for improvements in preserving potatoes, roots, plants, grain, and seeds.
1439. Thomas Slater, of Somers-place West, St. Pancras, and Joseph Tall, of Crawford-street, Marylebone, for improvements in the construction of planes, and in cutting apparatus, and in the machinery employed therein.
1440. John Henry Johnson, of Lincoln's-inn-fields, for improvements in machinery or apparatus for winding thread or yarns, —being a communication.

*The above bear date June 30th.*

1441. Robert Lewis Jones, of Chester, for improvements in locks and keys.
1442. Joseph Hulme, of Manchester, for improvements in steam-engines, and in valves; parts of which improvements are applicable for diminishing friction in other engines.
1444. John Henry Johnson, of Lincoln's-inn-fields, for improvements in submarine navigation, —being a communication.
1445. John Henry Johnson, of Lincoln's-inn-fields, for improvements in stoppers for bottles and other vessels, and in apparatus connected therewith, —being a communication.
1446. George Hutchison, of Glasgow, for an improvement or improvements in the manufacture of soap.
1447. John Wilder, of Reading, for improvements in agricultural rollers and clod crushers.

*The above bear date July 1st.*

1448. John Kolbe Milne, of Edinburgh, for an improved means of holding letters, documents, or other similar articles.
1449. Benjamin Walters, of Wolverhampton, for improvements in spindles for locks and latches, and in the means of adjusting knobs to the same, to suit any thickness of door.
1450. Peter Armand Le Comte de Fontainemoreau, of South-street, for improvements in stopping bottles, and in drawing off aerated or other liquids contained therein, —being a communication.
1451. Walter Greenshields, of Edinburgh, for improvements in Chenille fabrics.
1452. William Balk, of Ipswich, for an improved friction dynamometer.

1453. Alfred Vincent Newton, of the Office for Patents, 66, Chancery-lane, for an improvement in the construction and arrangement of marine steam-engines,—being a communication.
1454. Joseph Hopkinson the younger, of Huddersfield, for improvements in steam-boilers and furnaces, and in apparatus connected therewith.
1455. Edouard Auguste Desiré Guichard, of Paris, for improvements in ornamenting the surfaces of various articles and fabrics.
1456. Urbain Chauveau and Charles d'Épinois, both of Paris, for improved means or apparatus for preventing collisions on railways.

*The above bear date July 3rd.*

1457. Joseph Sunter, of Derby, for new or improved drilling machinery.
1459. Christopher Thomas Tiffany, of Leeds, for an improvement in the manufacture of brushes used in gig mills, and machinery for brushing piled fabrics.
1460. Thomas Haines, of Melbourne, near Derby, for improvements in the manufacture of gloves and mits by warp machinery.
1461. John Mc Gaffin, of Liverpool, for improvements in corrugated cast-iron.
1462. Jean André Cécile Nestor Delpech, of Castres, France, for an improved lift and force-pump, called "Castraise pump."
1463. James Newman, of Birmingham, for improvements in the manufacture of metallic rods, rails, and bars.
1464. Joseph Marie Bardet and François Collette, both of Paris, for an improvement in the construction of matches.
1465. Richard Garrett and Richard Garrett, jun., of Leiston Works, near Saxmundham, for improvements in machinery for drilling seed and manure.
1466. George Daniel Bishopp, of Inverness-terrace, for improvements in the construction and arrangement of engines to be driven by steam, air, gases, or water.
1467. Thomas Elliott, of Manchester, for improvements in safety-valves and apparatus connected therewith; which valves may also be used as steam-valves.
1468. Henry Heycock, of Manchester, for certain improvements in hydraulic presses employed for packing or pressing cotton, silk, flax, wool, or other fibrous materials.
1469. David Bowlas, of Reddish, Lancashire, for certain improvements in machinery or apparatus for knitting or manufacturing healds or harness used in looms for weaving.
1470. John Henry Johnson, of Lincoln's-inn-fields, for improvements in obtaining motive power,—being a communication.
1471. John Henry Johnson, of Lincoln's-inn-fields, for an improved system or mode of coating iron with copper,—being a communication.

*The above bear date July 4th.*

1472. Louis Joseph Cheval, of Raismes, France, for improvements in beer-engines.  
 1473. Joseph Burch, of Crag Hall, near Macclesfield, for certain improvements in marine and other steam-engines.  
 1475. Thomas Restell, of the Strand, for an apparatus or holder for holding parcels of gloves and other goods and papers.  
 1476. William Symes, of Pimlico, for improvements in tills.

*The above bear date July 5th.*

1480. John Glasgow, of Manchester, for improvements in machinery or apparatus for cutting, compressing, punching, shearing, and shaping metals.  
 1482. Otis Avery, of Castle-street, for improvements in sewing and stitching machines.  
 1484. John Lamb, of Newcastle-under-Lyne, for improvements applicable to machines for cutting paper.  
 1486. John Radcliffe, of Stockport, for certain improvements in power looms for weaving.  
 1488. John Henry Johnson, of Lincoln's-inn-fields, for improvements in electro-magnetic engines,—being a communication.  
 1492. John Petrie, jun., of Rochdale, for improvements in machinery or apparatus for washing or scouring wool.

*The above bear date July 6th.*

---

### **New Patents.**

*Sealed under Patent Law Amendment Act, 1853.*

- |  |  |
|--|--|
| <p>1853.<br/>           2999. S. Sedgwick and T. Dawson.<br/>           3000. T. S. Prideaux.<br/>           3007. Richard Green.<br/>           3020. C. A. Roux.<br/>           3023. W. Pickstone and J. Booth.<br/>           3031. H. V. Physick.<br/>           3034. Weston Tuxford.<br/>           3038. James Slator.<br/>           1854.<br/>           4. James Gowans.<br/>           11. James Stovold.<br/>           16. Thomas Mann.<br/>           19. David Hulett.<br/>           23. D. B. Whitc.<br/>           27. J. Mason and L. Kaberry.<br/>           30. H. H. Edwards.<br/>           39. A. B. Von Rathen.<br/>           48. Richard Husband.<br/>           52. Edward Tyer.<br/>           53. William Brown.<br/>           66. William Watt.<br/>           67. F. L. Bauwens.</p> | <p>69. Ralph Lister.<br/>           72. F. Tussaud.<br/>           85. J. H. Johnson.<br/>           89. P. O'Malley.<br/>           94. J. Jeffreys.<br/>           96. Charles F. Stansbury.<br/>           98. James Newall.<br/>           113. B. G. Sloper.<br/>           122. Charles Howard.<br/>           127. Joel Spiller.<br/>           135. C. W. R. Rickard.<br/>           136. Henry Direks.<br/>           140. O. R. Chase.<br/>           144. Richard Roberts.<br/>           148. G. Grace and T. F. Jones.<br/>           149. John Westerton.<br/>           153. Peter Spence.<br/>           156. Andrew Shanks.<br/>           170. P. A. Le Comte de Fontaine-<br/>                 moreau.<br/>           171. R. A. Brooman..<br/>           172. R. A. Brooman.<br/>           174. A. W. Sleigh.</p> |
|--|--|

175. G. Williams.  
 185. E. B. Walmsley.  
 190. A. L. Reid.  
 192. Thomas Wickstead.  
 199. George Firmin.  
 201. P. M. Crane.  
 202. A. C. De Simencourt.  
 213. W. Williams.  
 223. William Hodgson.  
 224. Earl of Aldborough.  
 238. L. C. Koeffler.  
 239. L. C. Koeffler.  
 240. W. Wright and G. Brown.  
 241. P. J. Meeus.  
 251. William Guest.  
 255. J. and R. Jobson.  
 258. J. D. Morrison.  
 261. Adolphe Mohler.  
 267. P. A. Le Comte de Fontaine-  
       moreau.  
 270. R. B. Newhouse.  
 273. William and John Longmaid.  
 277. George Milla.  
 282. E. Cole.  
 289. J. B. Graham.  
 300. A. F. D. Duvallier.  
 305. B. U. Bianchi.  
 309. John Ramsbottom.  
 310. John Dalton.  
 320. David and John Brown.  
 331. James Mitchell.  
 336. Gregory Bird.  
 355. Louis Faure.  
 383. George Smith, jun.  
 392. B. W. Wells.  
 408. John Ramsbottom.  
 418. J. H. Johnson.  
 424. W. E. Newton.  
 438. William Hunt.  
 456. A. E. L. Bellford.  
 462. James Keenan.  
 513. Thomas Dawson.  
 553. W. J. Cookson.  
 568. J. H. Swan.  
 582. A. V. Newton.  
 591. James Wright.  
 610. A. W. Conner.  
 611. J. H. Swan.  
 616. P. A. Le Comte de Fontaine-  
       moreau.  
 625. T. W. Keates.  
 715. John Roberts.  
 761. R. E. Hodges.  
 781. W. E. Newton.
786. G. F. Wilson & J. M. Whiting.  
 799. A. V. Newton.  
 817. J. R. Johnson.  
 819. William Rigby.  
 822. W. E. Newton.  
 825. A. V. Newton.  
 826. Thomas Bromley.  
 827. John Platt.  
 838. A. S. Bolton and F. S. Bolton.  
 839. A. S. Bolton and F. S. Bolton.  
 845. Edward Lavender.  
 852. J. Miller, jun. & M. Burke.  
 871. H. Meyer.  
 896. William Denton.  
 937. W. E. Newton.  
 939. William E. Newton.  
 943. R. F. Sturges.  
 955. J. H. Johnson.  
 964. John Evans.  
 974. Walter Macfarlane.  
 978. John Clarke.  
 992. J. H. Johnson.  
 993. W. W. Richards.  
 997. W. H. Knapp.  
 999. E. Barlow, W. Johnson, W.  
       Slater, and P. Knowles.  
 1001. James Nasmyth.  
 1004. William Exall.  
 1005. F. C. Hills.  
 1006. Edwin Haseler.  
 1009. Joseph Wonfor.  
 1014. B. J. La Mothe.  
 1016. B. J. La Mothe.  
 1022. J. H. Johnson.  
 1034. F. P. Berques.  
 1037. A. V. Newton.  
 1038. E. N. Horsford.  
 1051. W. De la Rue.  
 1053. Alfred Vincent Newton.  
 1056. J. Penton and J. Mackay.  
 1065. Moses Poole.  
 1071. A. V. Newton.  
 1084. John Chedghey.  
 1085. W. E. Newton.  
 1086. Frederick East.  
 1087. F. W. Miller.  
 1104. James Horsfall.  
 1105. John Beads.  
 1109. J. C. March.  
 1111. J. Maclean and T. Finlayson.  
 1117. E. A. D. Guichard.  
 1171. A. Livingston, jun.  
 1173. G. Chilson.  
 1175. M. Loomis.

\*\* For the full titles of these Patents, the reader is referred to the  
 corresponding numbers in the List of Grants of Provisional Protections.

CELESTIAL PHENOMENA FOR AUGUST, 1854.

D.	H.	M.	
1	—	—	Clock before the ☉ 6m. 3s.
—	—	—	☽ rises 0h. 35m. A.
—	—	—	☽ passes mer. 5h. 40m. A.
—	—	—	☽ sets 10h. 39m. A.
2	44	—	♃'s first sat. will em.
10	28	—	☽ in ☐ or first quarter
2	4	49	♃ greatest hel. lat. S.
9	13	—	♃'s first sat. will em.
16	—	—	Vesta in conj. with Juno, diff. of dec. 1. 4. N.
19	33	—	Ceres in oppo. ☉ intens. of light 0.697.
3	—	—	Ocul. ♀ Ophiuchi, im. 9h. 26m. em. 10h. 35m.
10	27	—	♃'s second sat. will em.
5	—	—	Clock before the ☉ 5m. 45s.
—	—	—	☽ rises 5h. 56m. A.
—	—	—	☽ passes mer. 9h. 28m. A.
—	—	—	☽ sets 0h. 4m. M.
6	7	46	♃ in conj. with the ☽ diff. of dec. 3. 32. N.
7	—	—	☽ in Perigee.
8	47	—	♃'s third sat. will em.
8	17	—	Ecliptic oppo. or ☉ full moon.
9	—	—	Ocul. ♂ Aquarii, im. 9h. 9m. em. 10h. 12m.
—	—	—	Ocul. ♀ Aquarii, im. 10h. 46m. em. 11h. 3m.
3	38	—	♃ in ☐ with the ☉
8	17	—	♃ stationary.
11	3	—	♃'s first sat. will em.
10	—	—	Clock before the ☉ 5m. 8s.
—	—	—	☽ rises 8h. 59m. A.
—	—	—	☽ passes mer. 1. 34. M.
—	—	—	☽ sets 6h. 40m. M.
11	3	—	♃'s second sat. will em.
15	—	—	Clock before the ☉ 4m. 23s.
—	—	—	☽ rises 10h. 19m. A.
—	—	—	☽ passes mer. 5h. 50m. M.
—	—	—	☽ sets 1h. 17m. M.
0	49	—	♃'s third sat. will em.
1	50	—	☽ in ☐ or last quarter.
16	—	—	Mercury, R. A., 8h. 27m. dec. 17. 43. N.
—	—	—	Venus, R. A., 7h. 41m. dec. 21. 13. N.
—	—	—	Mars, R. A., 13h. 23m. dec. 9. 5. S.
—	—	—	Vesta, R. A., 12h. 35m. dec. 2. 8. N.

D.	H.	M.	
16	—	—	Juno, R. A., 12h. 28m. dec. 2. 22. N.
—	—	—	Pallas, R. A., 18h. 56m. dec. 15. 41. N.
—	—	—	Ceres, R. A., 20h. 55m. dec. 30. 26. S.
—	—	—	Jupiter, R. A., 19h. 22m. dec. 22. 33. S.
—	—	—	Saturn, R. A., 4h. 52m. dec. 20. 51. N.
—	—	—	Uranus, R. A., 2h. 57m. dec. 16. 28. N.
—	—	—	Mercury passes mer. 22h. 49m.
—	—	—	Venus passes mer. 22h. 4m.
—	—	—	Mars passes mer. 3h. 45m.
—	—	—	Jupiter passes mer. 9h. 42m.
—	—	—	Saturn passes mer. 19h. 11m.
—	—	—	Uranus passes mer. 17h. 16m.
22	12	—	♃ in conj. with the ☽ diff. of dec. 3. 13. S.
17	1	3	♃'s first sat. will em.
18	0	19	♃ greatest elong. 18. 31. W.
7	32	—	♃'s first sat. will em.
19	—	—	Ocul. A. Geminorum, im. 13h. 46m. em. 14h. 17m.
9	—	—	☽ in Apogee
17	29	—	☽ in the ascending node.
20	—	—	Clock before the ☉ 3m. 13s.
—	—	—	☽ rises 0h. 48m. M.
—	—	—	☽ passes mer. 9h. 35m. M.
—	—	—	☽ sets 6h. 17m. A.
14	10	—	☽ in conj. with the ☽ diff. of dec. 4. 27. S.
21	4	43	♃ in the ascending node.
12	46	—	♃ in conj. with the ☽ diff. of dec. 4. 53. S.
22	4	48	♃ stationary.
23	6	0	Ecliptic conj. or new moon.
25	—	—	Clock before the ☉ 1m. 58s.
—	—	—	☽ rises 6h. 34m. M.
—	—	—	☽ passes mer. 1h. 26m. A.
—	—	—	☽ sets 8h. 3m. A.
9	27	—	♃'s first sat. will em.
18	26	—	♃ in Perihelion.
27	22	8	♃ in conj. with ♃ diff. of dec. 2. 49. S.
28	7	32	♃'s second sat. will em.
31	6	7	☽ in ☐ or first quarter.

J. LEWTHWAITE, Rotherhithe.

THE  
LONDON JOURNAL,  
AND  
REPERTORY  
OF  
Arts, Sciences, and Manufactures.

---

CONJOINED SERIES.

---

No. CCLXXIII.

---

RECENT PATENTS.

*To WILLIAM BRIDGES ADAMS, of Adam-street, Adelphi, in the county of Middlesex, engineer, for improvements in railway wheels, their axles, and boxes.—[Sealed 8th December, 1853.]*

THIS invention relates to certain means of constructing railway wheels of a disc form, that is, with solid centres instead of open spokes, in order to prevent them from acting as fans and causing increased atmospheric resistance, and also the better to maintain a true circular form, and thus enable the tyre to be worn down thinner; and also to the rendering of the rolling surface of the tyre as hard as possible. In Plate V., figs. 1, and 2, shew, in side view and section, one mode of constructing a wheel with a disc body of timber. A sufficient number of wedge-form pieces of timber A, A, of any suitable kind, as oak or good fir, are cut by hand or by a machine accurately. These are connected together in a circle by dowels or by tongues of thin iron *a, a*, fig. 2. The frame thus formed is placed centrally on a circular table revolving on a vertical axis, the table being adjustable slightly out of the horizontal level. At a convenient adjustable distance from this table, a vertical saw with a narrow blade is made to work. A hole is cut in the edge of the disc to admit the saw; and while the saw works vertically, the table revolves by a corresponding click action. The disc is thus cut to a true circle, conical on the edge. It is then forced, by hydraulic or other pressure, into a peculiarly-formed tyre B, B, with an internal rib *b, b*, about an inch and a quarter in depth near the external edge. A flat ring of iron *c, c*, fig. 2, is then forced upon the wood disc at

the back; fitting either tightly or loosely within the tyre. Holes are pierced in this ring, and bolts with fang heads *d, d*, nipping into a groove on the front rib of the tyre, pass through the wood and the ring, and are secured by nuts at the back. Thus the whole wheel is firm, and the tyre is fixed without holes, and may be worn down to little more than three-eighths of an inch in thickness. Instead of fang heads being used, the rib may be rolled wider, and bolts passed through it; but this is not preferred, as it involves a more expensive manufacture. To form the centre of the wheel, a disc *c, c*, is cast with a projecting boss or centre *e, e*. The wheel being chucked or centred true to the tyre against a boring bit, the centre is bored out, and the cast disc *c*, is forced in by pressure. Another disc *d, d*, is fixed on the front, fitting the box *e, e*; and the two discs being bolted together, through the thickness of the timber, by the bolts *e, e*, the central hole for the axle *h, h*, is bored out, and the axle is keyed in, in the usual manner, if intended for a fast wheel; in which case the length of the nave or hub is indicated by the dotted line *f*, fig. 2. But if the wheel be intended to revolve on the axle, the nave or hub must be prolonged, and abut against a collar at *g*; and a loose collar must be fixed to the axle in front, to prevent the wheel coming off at *h, h*; or some equivalent contrivance must be adopted, and a reservoir for oil or grease must be provided, as *i, i*. Instead of the disc of timber, a disc of sheet iron or boiler plate may be used in the same manner; only in such case the internal rib on the tyre may, in preference, be placed nearer the centre width of the tyre, so as to tread firmly. It is obvious that in making use of this ribbed tyre, it may be applied also to spoke-wheels,—the fang-bolts passing through or between the spokes; though not so good a plan as the disc. The disc wheel of wood will serve advantageously, by its elastic action, to moderate percussion; and the disc of iron will also act very advantageously, yielding laterally, with elastic action, to moderate the blows of the flanges against the rails.

Another part of this invention consists in forming wheels with central discs of iron, either wrought or cast, (though wrought is preferred) as shewn at figs. 3, and 4, in front view and section. A disc of wrought-iron *A, A*, is prepared with a large hole pierced in the centre, surrounded by a number of smaller holes *a, a*, about an inch in diameter; and round the periphery a number of similar holes *b, b, b*, is pierced, at an inch apart or thereabouts. Iron chills or moulds being prepared to suit the nave and the tyre, the disc is placed in them, either cold or heated to a proper degree of temperature, and

the melted iron is poured upon it in the usual mode of forming cast-iron wheels. The chill-moulds being in contact with that portion of the tyre required to be hardened, as the face and flange of the tyre *c, c*, and loam or sand applied to the other portions, the hardening will take place only at the face and flange, and the other portions will be soft and tough. The cast tyre *B, B*, so formed, will be truly circular; and being as it were rivetted to the disc at every inch, even in case of cracking, it will not come off or cause damage. Instead of the holes at the periphery, projections, or hollows, or fangs may be used, as shewn at fig. 5. And instead of the central hub being cast on to the disc, it may be bolted in two parts, as shewn in figs. 1, and 2, or rivetted. Supposing a cast-metal disc to be used with the cast tyre, the wheel will not be so liable to break as when cast in a single piece. But of course the cast-metal discs must be ribbed or corrugated on the faces to strengthen them; a thing not required in the wrought-metal discs. Instead of a plain flat sheet of boiler-plate, to form the disc, corrugated metal may be used; the corrugations radiating from the centre.

To obviate the disadvantages arising from fixing two wheels fast on one shaft, the patentee arranges the wheels, with a centre or boss elongated to about half the diameter of the wheel, to revolve either one or both on the shaft, at the same time that the shaft is free to revolve in the ordinary bearing or bearings. In this mode the wheels can accommodate themselves to the pathway, and the sledging movement will not exist, but a simple rolling movement will take place, and the tyres and rails will be saved from much abrasion, and less haulage power will be required; and in this mode the disc wheels with chilled tyres will be exceedingly durable. The wheel is shewn at fig. 4, with an elongated boss, and fast and loose collars on the axle *h, h*, as before described for the wood disc wheel; but, if preferred, the wheel may be fast, and the boss or hub left shorter, as indicated by the dotted lines *f, f*. The oil chamber is shewn at *i, i*. And instead of always fixing the rib tyre by means of fang-bolts, as before described, the method, shewn in section at fig. 6, may be used. A groove *a*, is sunk in the tyre at the back of the disc *b*; and in this a hoop of iron or steel *c*, is placed, out of which a piece is notched to permit the circle to be diminished by pressure. It may thus be pressed into the groove, and be expanded by a rivet, or screw, or wedge *d, d*, at the opening, and will thus remain tight and firm. Two of these expanding rings may be used, one in front of and one behind the body of the wheel,



recessing into the tyre, and thus dispensing with the rib on the tyre. Instead of being flat rings, as shewn at fig. 6, they may be made two or three inches wide, and bolted together through the body. In the wheels which are to revolve loosely on the shafts the long boss is important, to keep the wheel steady and prevent wear; this boss may be case-hardened, or may be lined with thin sheet-steel or other metal, so as to replace when worn. And the rib-tyres and cast-tyres, before-mentioned and described, may be constructed with the guiding flange in the centre of the tread, to use with channel rails for streets in towns, or for highways; such rails being level with the road, in order not to interfere with ordinary traffic. This tyre is shewn at fig. 7.

For the before-described wheels, axles of the ordinary kind, with a new kind of journal, as shewn at fig. 8, are proposed to be used. Instead of the ordinary flange on the end of the axle journal, to preserve its place in the bearing, a flange *a*, is placed at or about the centre of the journal, which is recessed into the bearing of the axle-box. Fig. 9, shews a similar journal, with the bearing *a*, double-coned; or one-half the bearing may be coned, and the other half cylindrical.

The axle-boxes for these journals are preferred to be made in two halves, with a bearing below to prevent the box from tilting. The steadiness will also be helped by the removal of the collar from the end to the centre, which will extend the length. Fig. 10, shews one of these boxes in longitudinal section with the axle; and fig. 11, is a cross section. *A, A*, is the axle; *a, a*, the central flange collar; *b, b*, the bearing brasses above and below; *c*, the grease or oil feed-hole; *d*, the grease or oil chamber. The feed-hole is on the collar, and is elongated for surface. As the grease or oil falls on both sides of the collar, it will gradually work its way along the bearing, and especially towards the larger diameter of the cones, shewn at fig. 9. Where the upper and lower halves of the box meet, grooves *e, e*, are provided, in which wood, hemp, or other elastic material is inserted, to make the joint oil and grease-tight, when bolted together by the bolts *f, f, f*. A feed-hole may be provided at the front of the box *h*, to lubricate the axle end; and a slide of metal may be applied through an opening indicated by the dotted lines *i*, to serve as a wearing piece, to be replaced when worn, to prevent end play; or such slides may be applied at the central collar on either side. A collar of wood *m, m*, fig. 9, fitting the axle, is applied at the back of the box, and so arranged, by recessing it in the box, that it forms as it were a part of the box, moving upwards in the box as the

bearing wears, but not revolving as the axle revolves within it. And instead of the usual cast-iron axle-box, the patentee prefers occasionally to cast the half boxes in the solid brass or bearing metal, for the purpose of reducing weight.

When using hollow axles, the patentee makes them by rolling bars of a segmental section, so that two, three, or more will build up into a tube. He then rolls another portion, to build a second tube outside the first, and so on a third or fourth tube. These segmental bars are clamped together in a large thick mass, with the joints open for the heat to enter; and are placed in a reverberatory furnace, in a soaking heat, where they remain until they are in a state for welding; they are then passed through rolls with a mandril inside, in the mode used for making gun-barrels. Fig. 12, shews the tube built up ready for welding. The thickness, when finished, is preferred to be about an inch, and the bearing may be turned down for fixed axles, and also for axles on which the wheels revolve. The coned bearings will be the strongest. The collars at the back of the revolving wheels may be welded on, or swaged, or shrunk on hot, or fixed with screws, as preferred.

The patentee claims, First, the mode, hereinbefore described, of constructing and applying tyres, with internal ribs formed or rolled on them, to solid metal or wooden disc wheels, or to spoke wheels, by means of bolts passing through the wheels laterally, parallel, or nearly so, to the tread of the tyre; the nuts being secured either on the body of the wheel, or on a ring of metal fitting against the body of the wheel, and supporting the tyre as a false rib, as hereinbefore described. Secondly,—these wheels with tyres so constructed and applied in combination with elongated centres arranged for the wheels to revolve on axles independently of each other; such axles also revolving in bearings of the common kind, or of the improved kind, as hereinbefore described. Thirdly,—the mode of forming wheels with disc bodies of cast or wrought metal, pierced with holes or provided with hollows or prominences at the peripheries,—the tyres and naves or bosses being cast thereon, or the naves bolted thereto; the wheels being either fast on the axle or running loose, as hereinbefore described. Fourthly,—the mode of fixing the rib-tyres, before described, to the bodies of wheels, by means of an expanding hoop fitting in a groove; the ends being secured by a wedge, bolt, or rivet; and also applying two such expanding hoops, dispensing with the rib, as hereinbefore described. Fifthly,—the mode of constructing axle bearings with a collar, either in the solid or fixed on it, at or about the centre of the bearings; such bearings

being either cylindrical or conical, as hereinbefore described. Sixthly,—the mode of constructing an axle-box so arranged as to clip the axle with bearings above and below, and prevent the box from tilting, and with a packed groove between the joint of the box, and with a front feed-hole, and sliding metal wearing plates in front, or in contact with the central collar, to prevent end play, and removable when worn; the box being used either with the central collar bearing only, or in combination with the other arrangements, as hereinbefore described. Seventhly,—the mode of constructing hollow axles, by means of segmental bars, in two or more circles, breaking joint with each other; the collars of such axles, when required for loose wheels, being either welded on in the solid, or shrunk on hot, as hereinbefore described.

---

To JOSEPH JOHN WILLIAM WATSON, of *Old Kent-road, in the county of Surrey, for improvements in illuminating apparatus, and in the production of light.*—[Sealed 7th March, 1853.]

THE improvements in the production of light consist in adapting the mixed gases, oxygen and hydrogen, as they are obtained from the decomposition of water by galvanic or other agency, to the purposes of illumination, by causing them to impinge, during their ignition, against certain non-combustible, or nearly non-combustible, radiating mediums, as lime, the earths, graphite, spongy platina, &c., or certain compositions hereinafter described. The materials, made up in suitable forms, may be either stationary, or may have the several movements described herein, with reference to the improved illuminating apparatus. Further, the improvements in the production of light consist in producing colored effects.

The improvements relating to the illuminating apparatus consist in certain arrangements and combinations for the purpose of illumination, by the combustion of a stream of oxygen and hydrogen gases, produced by galvanic and electric agency, and directed against various solid substances.

In Plate V., fig. 1, represents a section of the improved illuminating apparatus. *a*, is a close vessel, composed of lead, or other material capable of resisting considerable internal pressure and the action of acids. It is filled to a certain height with water, slightly acidulated with sulphuric or muriatic acid. *b*, is a fountain reservoir, fitted into the top of *a*, and containing liquid of the same quality as that in the vessel *a*. A small open pipe *b*<sup>1</sup>, projecting from the bottom

of the fountain, allows the liquid to descend into the vessel *a*, until the lower aperture of the pipe is closed by the liquid; whereby the liquid in *a*, is constantly maintained at the same height as in fountain lamps. *b*<sup>2</sup>, is a funnel (fitted with a stop-cock *b*<sup>3</sup>,) whereby the liquid is introduced into the reservoir. *c*, is a tube of copper or block-tin, screwed into the top of *a*, and filled with brass wires *c*<sup>1</sup>, of about  $\frac{1}{3}$  of an inch in diameter,—the wires being retained in their places in the tube by discs *c*<sup>2</sup>, of wire-gauze or perforated metal. *c*<sup>3</sup>, is a stop-cock, fitted on the tube; and *c*<sup>4</sup>, a platina nozzle, fixed on the stop-cock, and having a very fine and minute aperture. *d*, *d*<sup>1</sup>, are two platina plates, of about four inches square, and separated from each other about one quarter of an inch. These plates are carefully insulated from any contact with the bottom of the vessel *a*, and communicate, by means of wires *d*<sup>1</sup>, *d*<sup>1</sup>, (concealed in the base *a*<sup>1</sup>, of the vessel) with the binding-screws *d*<sup>2</sup>, *d*<sup>2</sup>. *e*, is a train, of any suitable construction, to cause the vertical spindle *e*<sup>1</sup>, to revolve with a uniform motion. This spindle is square, and upon it is loosely fitted the cylinder *f*, which has a square aperture running throughout its length, to receive the spindle *e*<sup>1</sup>. This cylinder is surrounded by a tube *f*<sup>1</sup>, which forms a collar at the top, to guide the cylinder. A continuous groove *f*<sup>2</sup>, is cut in the cylinder, forming a kind of right and left-handed screw, and receives a peg *f*<sup>3</sup>, inserted in the collar; so that, during the revolution of the spindle, the cylinder, whilst carried round in one direction, is caused alternately to ascend and descend along the spindle.

In a recess or socket in the cylinder *f*, is fixed a cylinder *g*, (or it may be a cone), the composition of which will be hereinafter described; and behind it is placed an ordinary reflector *h*. It has a square hole running through it to receive the spindle. The train *e*, is moveable between guides along the top of the vessel *a*, by means of a lever *k*, and pawl *k*<sup>1</sup>, attached to the frame of the train, and acting upon a rack *k*<sup>2</sup>, attached to the top of the vessel *a*. *m*, is a pressure-gauge, partially filled with some colored liquid; *n*, is a water-gauge; and *p*, is a cap or cover, closing in the train. The mode of preparing the apparatus for use is as follows:—The stop-cock *c*<sup>3</sup>, is opened, and dilute sulphuric or muriatic acid (preferably sulphuric acid, of the strength of about twenty parts of water to one of acid) is poured through the funnel, until the liquid has risen as high as the bottom of the reservoir, as indicated by the water-gauge. The cock *c*<sup>3</sup>, is then to be closed, and the liquid continued to be poured into the reservoir until it

is nearly filled, when the cock  $b^3$ , of the funnel, is to be closed, and the cock  $c^3$ , again opened. The poles of a galvanic battery, or magneto-electric engine, are next attached to the binding-screws  $d^2$ ,  $d^2$ , and immediately a decomposition of the water will ensue and the gases will rise from the platina plates. During the time the mixed gases and the air contained in the chamber are escaping through the cock  $c^3$ , the clock-work should be wound up. The stop-cock  $c^3$ , of the jet is then to be shut; and after the expiration of two or three minutes, when the pressure-gauge shews a pressure of about one to two atmospheres, it is to be again opened about three-fourths, when a fine stream of the gases will issue and impinge upon the cylinder  $g$ ; and, upon igniting the jet, a most brilliant light will result, which will be thrown forward in rays by the reflector into the surrounding space. The operation of the train at the same time causes the cylinder to rotate, and to ascend slowly along the spindle, and thereby to expose, continually, a different portion of its surface to the action of the pencil of flame. This action causes the abrading of the material to form a spiral groove round the cylinder. During the descent of the cylinder, the action of the flame tends to erase the groove made whilst rotating upwards, and cuts for itself a new groove, running in the opposite direction. Towards the end of the descent, the cylinder  $f$ , depresses the lever  $k$ , and thereby advances the train towards the jet or burner through a small space, so as to about compensate for the diminished diameter of the cylinder  $g$ , and to maintain it at nearly the same distance from the burner. The object of filling the tube  $c$ , with brass wires, is to prevent the flame from passing down to the gas contained in the vessel  $a$ , and thereby causing explosion,—the wires cooling the gases below the point of ignition, in the event of the flame passing backwards. The jet should be as slender as possible, and very short, in order to allow of as little accumulation of gas, above the wires in the tube, as possible.

In the event of the liquid in the vessel  $a$ , falling below the top of the plates, the latter would become incandescent, and probably cause the gas in the vessel to explode. A metallic float  $q$ , is therefore provided, which, before the water has descended too low, comes into contact with the decomposing plates  $d$ ,  $d$ , and thus, completing the circle, suspends the decomposition of the water.

The patentee sometimes surrounds the cylinder  $g$ , with a coil of very fine platina wire, and finds that the radiation of the light is diffused over a larger space by the radiation of the glowing platina.

As already stated, the medium against which the flame of the mixed gases impinges, may be composed of lime, earth, graphite, spongy platina, &c.; but it is preferred to prepare the cylinders, cones, or other forms, used for the radiation of the light, in the following manner:—Quick lime and powdered graphite from gas-retorts, or the scurf from coke-ovens, in the proportion of ten parts of lime to three parts of the carbonaceous matter, are mixed with water into a paste; to which is then added about one-fifth part of the best china clay or pipe clay. The paste then, after being well kneaded, is to be placed in small iron cylinders, and carefully dried in a stove, and afterwards brought to a white heat in a closed iron box, each cylinder being well bedded in a stratum of quick lime. Spongy platina is also occasionally employed for the formation of the cylinders; and by steeping such in nitrate of strontian, or other substances used for pyrotechnic displays, colored effects are obtained. The hole to admit of the introduction of the spindle into the centre of the cylinder is formed by thrusting a solid iron rod into the iron mould when filled with the paste. This rod is left in the mould during the drying of the paste-cylinder. In mixing the materials, a small portion of saccharine matter (treacle answers very well) is added, to prevent the composition from cracking when exposed to a white heat.

The patentee observes, that the adjusting apparatus, for the radiating medium (apart from the illuminating apparatus described above), is applicable to the "Drummond light," or to any apparatus in which a mixture of oxygen and hydrogen gases are burnt. Thus water may be decomposed, on a large scale, by galvanic agency, in works adapted to the purpose, and the mixed gases, resulting therefrom, conveyed by pipes to the burners, as is now ordinarily practised with coal-gas.

He claims, First,—the application of the mixed gases, oxygen and hydrogen (obtained by the decomposition of water by galvanic agency), by directing the flame, resulting from their combustion, against a radiating body, composed of suitable incombustible or difficultly combustible substances, as lime, earths, graphite, and spongy platina, or of the mixed materials hereinbefore described. Second,—the increasing the light from the radiating body, by surrounding it with a coil of fine platina wire. Third,—the producing colored light, by directing a stream of hydrogen gas, or of a mixture of oxygen and hydrogen gas, on to spongy platina, treated as hereinbefore described. Fourth,—the general arrangement of the illuminating apparatus hereinbefore described.

Fifth,—the application of a metallic safety-float, which, in the event of the water in the gas-generating chamber falling too low, establishes a metallic connection between the decomposing plates, and thus arrests the further decomposition. Sixth,—the application of apparatus, moved by clock-work, to impart a rotatory reciprocating and advancing motion to the radiating body on which the flame impinges, in lamps of any construction for the burning of hydrogen or oxyhydrogen gas, from whatever source obtained.

---

To THOMAS RUSS NASH, of *Leigh-street, in the county of Middlesex, surveyor, for improvements in filters.*—[Sealed 4th June, 1853.]

THIS invention relates to tubular filters, and consists in improvements upon a "self-cleansing tubular filter," for which William Murray obtained protection under the Designs Registration Act, April 8th, 1850.

These improvements are, first, the addition to tubular filters of a finely-perforated conical tube, or of a sheet of wire gauze formed into the shape of a conical tube; and, second, a means of readily fastening and unfastening the parts of the barrel in which such filters may be placed.

In Plate V., fig. 1, represents an exterior elevation, and fig. 2, a longitudinal section of a tubular filter, constructed according to this invention, and inserted in an outer barrel. A, A, is the exterior barrel or casing, which is divided in the centre, but connected together by flanges and screws B, B; C, is the supply, and D, the discharge-pipe, which are connected to the casing A, by the union-joints E, E. F, F<sup>1</sup>, are socket-pieces, fitted into the interior ends of the casing; G, is the conical tube of fine gauze, which is secured in the centre of the casing by the base or end *a*, being slightly turned over the piece F,—the other end *x*, of the conical tube being supported centrally by three pieces of metal *b, b*, soldered on or otherwise fixed to the tube; and H, is a cylindrical tube, which surrounds the conical tube, and is pierced with much coarser perforations. This tube is fitted into sockets *c, c*, formed in the pieces F, F<sup>1</sup>, whereby it is retained in its position. I, I, is a roll, formed of several thicknesses of flannel, linen, or other suitable filtering medium, attached at the ends to the pieces F, F<sup>1</sup>, as shewn in fig. 2. K, is a tap for drawing off the filtered liquid, which is contained in the space between the exterior of the filtering cylinder and the interior of the casing

A, A; and L, is a tap, upon the discharge or draw-off pipe, for unfiltered liquid.

The action of the filter is as follows:—On the tap L, of the discharge-pipe being turned, the water (supposing that to be the liquid to be filtered) rushes from the cistern or other source of supply into the larger end of the conical tube, through it, and into the draw-off pipe. But the water to be drawn off clear and filtered, percolates the conical tube, leaves therein the grosser matters with which the water may be impregnated, passes through the cylindrical perforated tube H, and roll of flannel or other filtering medium surrounding it, and is drawn off from the tap K, connected to the outer casing. The check the unfiltered water receives on shutting off the discharge-tap L, creates a disturbance in the foul water, which loosens the deposit on the conical tube; and, on the foul water tap being again opened, this deposit will be drawn off through it. When it is required to cleanse either of the interior parts of the filter more thoroughly, or should any of them require to be renewed from wear, the casing may be separated and the filter removed, by unscrewing the screws in the flanges B, B, and by unscrewing the joints E, E; when free access can be had to the interior parts of the filter. Fig. 3, shews the improved filter fitted inside a cistern.

The patentee claims, First,—the placing of an interior conical perforated tube, or fine wire-gauze formed into the shape of a tube, in tubular filters, in the manner and for the purpose hereinbefore described; and, Secondly,—the means of fastening and unfastening the parts forming the casing for tubular filters, of the description hereinbefore explained, by flanges and screws.

---

*To HESKETH HUGHES, of Cottage-place, in the county of Middlesex, engineer, for an improved method of producing cut and fancy patterns in velvets, silks, and other textile fabrics.*—[Sealed 13th August, 1853.]

IN producing cut and fancy patterns, it has hitherto been the practice to perform the operation of cutting and perforating by hand, and also to make use of a sharp cutting edge. Now this invention consists in employing a blunt edge, and in crushing out, by great pressure, the parts that are to be cut away to produce the pattern. The patentee employs two engraved rollers, preferring hardened steel, with the desired pattern engraved on one or both rollers, leaving such parts as are to be embossed, if any, in high relief upon one roller, and



such as are to be cut out in still higher relief. The rollers are set at the proper distance apart ; and, by pressure, the open parts or spaces of the pattern are, as it were, ground or pulverized out; while an embossed or other fancy pattern may at the same time be produced. The rollers must be cleared of the pieces so ground out, by a scraper or strong brush. Or the embossed pattern is surrounded with a triangular-shaped cutting edge, the height of which, above the embossed pattern, is exactly equal to the thickness of the fabric to be operated upon. Also, should it be desired to introduce a perforation or other open device in the embossed portion of the fabric, such device is formed of a triangular or blunt-shaped cutting-edge ; whereby, as the fabric is passed between the rollers, such devices or open patterns are punched or cut out at the same time that the embossing is performed. In some cases three rollers are used ; the lower one of which is plain, while the two others are so placed in reference to the lower roller that their surfaces will be in contact. Upon one or other of the two upper rollers, the pattern to be embossed upon the fabric is engraved, or otherwise formed ; while upon the other roller are formed the cutting-edges, so as to impart to the fabric its finished appearance. In all cases heat is applied to the rollers by means of jets of gas, whereby a set is given to the embossed portion of the design ; while, at the same time, the cut edges are prevented from becoming unravelled.

In Plate V., fig. 1, is a sectional elevation of a machine constructed according to these improvements. *a, a*, is the frame-work ; *b*, and *c*, are two rollers, superposed the one above the other, the spindles of which turn in brasses in the slots *d*, of the framework. The lower roller is plain, and turns in fixed brasses, while the upper roller has engraved or otherwise formed upon it, in relief, the device or pattern which it is intended to impart to the fabric passing between the rollers.

The upper roller is kept in contact with the lower roller by the set screws *d*. Upon the spindles of the rollers are keyed toothed-wheels, which gear into one another, and are driven by a pinion geared into by a toothed-wheel upon the spindle of the fly-wheel, which is set in motion by a crank-handle, or other equivalent means. *e*, is a gas-pipe, pierced with a row of holes, from which issue jets of flame for heating the rollers.

Fig. 2, represents an arrangement of three rollers ; one of the upper ones that is to give to the fabric the embossed appearance, having the pattern formed upon it in relief, by en-

graving, or otherwise; while the other has upon it the cutting-edges for finishing the ribbon, trimming, or other article under process of manufacture. Should it be desired, four rollers may be mounted in the same framework; the first pair of which imparts to the fabric the embossed portions of the design, while the other pair cuts off the superfluous waste, or perforates the fabric in accordance with the desired pattern; but it is preferred to use either of the arrangements represented in figs. 1, and 2, as the fabric is liable, in passing from one pair of rollers to the other pair, to become stretched, and thereby to distort and spoil the design. In some cases, it will be found advantageous to form the embossing and cutting roller partly of brass or gun-metal, and partly of hardened steel, in the manner represented in the section of one of the rollers in fig. 3,—the cutting-edges being formed of the hardened steel, and the embossed pattern engraved upon the surface of the tubes *a, a*, of gun-metal or brass, which are passed over the axis of the hardened steel roller until their edges meet, and thereby perfect the design, when they are held there by the screws *b, b*: or recesses may be formed in the rollers, in which may be fitted dies having engraved upon their surfaces the desired pattern; these dies being retained in their proper positions by countersunk screws. By this arrangement the embossed pattern may be altered in a great variety of ways, but still preserving the same outline or cutting-edges.

The patentee claims the producing cut and fancy patterns in velvets, silks, and other textile fabrics, by means of the several arrangements of rollers as hereinbefore described and represented in the drawings.

---

To JAMES HILL DICKSON, of *Evelyn-street, Lower-road, Deptford, flax manufacturer and flax machinist, for improvements in machinery or apparatus for the preparation of flax and similar fibrous material.*—[Sealed 18th September, 1853.]

THIS invention consists in the adaptation, to the purposes of beating and preparing raw or retted flax, of a series of fluted rollers, mounted in a frame, with a large fluted roller in the centre. The first-named rollers not only revolve, but move to and fro (on moving plummer blocks), in order to allow a greater or less supply of flax stalks to pass between their surfaces and the surface of the large roller, and also to effect the beating out as well as the breaking thereof. The flax

having passed through this machine, then goes through a similar machine,—differing only in having more rollers, and being more finely fluted. From this machine it passes to a third machine, which has four lower rollers presenting finer teeth or sharp ridges, between which are also open spaces; and the roller in the centre is similarly constructed with spaces between the ridges. The centre roller, although it revolves, does not touch the surface of any of the smaller rollers: the large roller works the small ones by fluted parts at each end thereof. In the two first machines motion is communicated from the fluted surface of the large roller to the fluted surfaces of the smaller rollers. The rims of the rollers have an annular projection thereon, which prevents them from closing in upon each other too far.

In Plate V., fig. 1, is an elevation of one of the machines aforesaid, and fig. 2, is a vertical section through the same. *c, c*, denote the framing of the machine, which is provided with bearings *d*, for the axle *e*, of the large centre roller *f, f*. The upper part of the framing, it will be observed, is circularly formed, and has projecting pieces *g*, to which are secured cross-pieces *h*, through an orifice in which works the end of a small spindle, around which is a helical spring *i*. The other end of the said spindle abuts against, and is secured to the top of the plummer blocks *k*, provided for the axles *l*, of the small or outer rollers *m*; two edges of each plummer block being V-shaped or otherwise formed, so as to slide up and down in V or other grooves in the said projecting pieces *g*, of the framing.

This arrangement of spindle, spring, and moving plummer blocks, is adopted for the aforesaid purpose of allowing the distance between the surfaces of the centre roller and the outer rollers to vary in extent, as may become necessary from any difference in the bulk of the feed.

By \*, the feeding point is denoted, and by \*\*, the delivery point. *n*, is a rim or hoop on the outer edge of each of the said rollers, projecting so far beyond the surfaces of the teeth of the rollers as may be necessary to keep them at such a distance apart as to prevent the flax or fibre being cut whilst breaking the woody part or shives. The wide flutes *o*, at each end of each of the outer rollers, are for the purpose of driving the roller; and this part of the roller is of larger diameter than the middle part of the roller.

The patentee remarks that his complete system of working necessitates the use of three machines similar to that exhibited by the drawing, differing only as hereinbefore stated; in which

case a delivery board will proceed from the delivery point of one machine to the feeding point of another machine. Thus No. 1, machine, which will have the widest flutes, will only partially prepare the flax, and render it fit only for ropemakers' use. No. 2, machine, being finer in the teeth, will operate better, and clean it sufficiently for fine twine makers. No. 3, machine will finally finish flax, and make it ready for the spinners of fine yarns. The three machines are required to commence and finish the process of breaking and cleaning out the woody parts or shives. On the first being fed, it passes to the second, and the second feeds the third.

No. 1, machine should consist of not less than six fluted outer rollers and one large centre roller, 2 feet 8 inches long, 1 foot 11½ inches in diameter. Four of the outer rollers are of solid metal, and two are not solid. The whole six outer rollers are made to work round the large centre roller: the two lower rollers, which are not solid, are brought up into work by levers and weights; and the other four rollers are brought down by their own weight, and the arrangement of helical springs and moving plummer blocks; whereby a beating as well as a revolving motion is obtained, according as a large or small handful or parcel of flax is entered from the feeding-board. The rim or hoop aforesaid also prevents the fluted teeth from entering too far into each other, and by this simple but very useful addition, along with the moving plummer blocks, the flax fibre can be completely separated from the wood, and without risk of being cut or injured; and consequently more fibre is produced from a given weight of flax straw than has ever before been taken by hand or machinery.

No. 2, machine differs from No. 1, in that it has more outer rollers (for instance, if six be used in No. 1, then twelve will be adopted in No. 2,) revolving round the large centre roller, and that they are ¼-inch finer or closer in the teeth or fluted parts; and the large roller being open between each tooth, or grate-like, the wood or shives, as the flax passes over it, falls through, and, consequently, the flax is better cleaned by this machine. The No. 1, machine breaks it open, so that the second or finer machine gets properly at or into it, and passes it through to the third or finishing machine.

No. 3, machine is much larger than Nos. 1, or 2: it has the same number as No. 2, of small fluted outer rollers, and one large centre roller,—the small rollers working round the large roller. In the moving plummer blocks, springs, and levers, the novelty and peculiarity of the invention is, that the increase of the diameter to 4 inches at each end of each of the

small rollers is allowed, to give motion from, whilst the centre of each, which is also grate-like, is 2 feet 8 inches in length, and acts on the fibre, never touching each other; consequently no portion of fibre can be cut or injured, whilst the woody part or shives, as they are broken, fall through the grate-like teeth of the large rollers, whereby the waste and expense of the scutching operation is dispensed with.

Flax, prepared by the above-mentioned machines in the green state, will be ready for sale without any other process; and retted flax can be equally prepared without incurring half the usual expense and no waste of fibre, but one-third more gained than by any other method of preparing it.

The patentee claims the improvements in machinery or apparatus for the preparation of flax and similar fibrous material, consisting of a machine or a system of two or three machines, each having a large centre roller driving a suitable number of smaller ones; the distance between the surfaces of the large and small rollers being adjusted by moveable plummer blocks and springs; such rollers being provided with a rim or flange to prevent their working too close to each other; and the centre roller in some cases being open between the teeth, or grate-like.

---

*To THOMAS WILLIAM KEATES, of Chatham-place, Blackfriars, in the City of London, chemist, for improvements in the distillation of turpentine and other resinous substances and their products.*—[Sealed 15th September, 1853.]

THIS invention of improvements in the distillation of turpentine and other resinous substances and their products has, for one of its principal objects, to obviate the necessity of employing a furnace or open fire in these processes, as is now the case, and in place thereof to make use of steam or heated air; the former being superheated, and used either alone or in combination with common steam.

The first part of the invention relates to the use of steam alone in the distillation of turpentine or other resinous matter.

The second part of the invention relates to the use of heated air as the medium of communicating heat to the crude turpentine or other resinous matter.

In distilling by steam, the patentee makes use of what he terms free steam; (that is to say,) steam superheated to the proper temperature, or modified by admixture with common steam, is allowed to escape into a still, through a coil of pipe

perforated with holes, and arranged near the bottom or other part of the still, and leading from the steam-boiler. By this arrangement the steam is blown through the contents of the still, and, by acting upon the resinous material, it will carry off therefrom the volatile essential oil or spirit, which, with the steam, is conducted into a refrigerator or worm, and there condensed in the usual manner.

By continuing to pass the steam through the turpentine or other resinous matter for a sufficient time, the essential oil or spirit will be driven off, and the residue will consist of rosin. The rosin is, however, at first opaque; whereas, for the purposes of commerce, it is necessary that it should be quite transparent. The clearing of the rosin, in the usual process of manufacture, is effected by the continued application of heat by means of an open fire; but, according to this invention, the steam is used to effect this object. The clarification of the rosin, cannot, however, be effected by common steam; as, when free common steam is used, it is impossible to obtain a higher temperature in the still than 212° Fahr., or thereabouts; at which temperature the excess of water cannot be expelled from the resinous residue of the distillation, and therefore the clarification cannot be effected.

In order to make the steam effective in clearing the rosin it is applied in a superheated state; and it is brought to this state by passing it, as it leaves the boiler, through a pipe or coil of pipe, arranged either in the flues of the boiler furnace, or in a furnace constructed for this especial purpose. This pipe may be heated to any required temperature up to a red heat; and the steam, as it passes through the pipe, acquires a temperature almost equal to that of the pipe itself. When the steam is passed into the rosin in this superheated state, it carries off the watery particles, and causes the rosin to become perfectly clear and bright. The patentee remarks that he does not consider the temperature to which the steam is to be superheated is a point of much importance with reference to the mere clearing of the rosin, provided it be sufficient to produce the required effect; but, with respect to the quality and color of the rosin so obtained, it is desirable that the steam should be used at as low a temperature as is consistent with its effective operation.

In using common steam in combination with superheated, it is proposed to arrange the apparatus in the following manner:—For conducting the steam into the still, two pipes are used, one leading directly from the boiler, and conveying common steam; the other also leading from the boiler, but

passing through a furnace, where it is arranged in a coil, in which the steam is superheated previously to its being conveyed to the still. These two pipes should be made to unite just before they enter the still, and each should be supplied with a cock; by which arrangement either common steam alone, or superheated steam alone, or the two combined in any proportion, may be admitted into the still: the temperature of the steam employed in the distillation may be exactly regulated by placing a thermometer in the pipe in which the pipes conducting the common and superheated steam respectively unite.

The figure in Plate V., shews an elevation of an apparatus constructed upon this principle. *a, a*, is the still, mounted on a suitable foundation, and surrounded with a casing or envelope, provided with any bad conductor of heat, so as to check radiation; *b, b*, is the still head; and *c*, the cock or exit aperture, from which the liquid residuum or rosin is run out, after the process is completed. *d*, is a steam-pipe, conveying common steam from a boiler; *e*, is another pipe, conveying superheated steam, which has been heated in pipes in a furnace not shewn in the drawing. These pipes *d*, and *e*, are connected to a common pipe *f*, which is provided with a thermometer *g*, to indicate the temperature of the steam that passes through it. Each of the pipes *d*, and *e*, is provided with a cock *h*, and *i*, for the purpose of opening or closing the communication, as before mentioned.

It is not positively necessary to employ superheated steam in the beginning of the distillation (that is, not until the essential oil is all expelled). Up to that point common steam may be blown through the resinous matters; but, for the removal of the opacity and cloudiness of the rosin, it is essential that the steam should be superheated to a temperature considerably above 212°. It is, however, better to employ the superheated steam from the first, and to regulate its temperature so that, until the whole of the essential oil is expelled from the rosin, the temperature of the steam, as it is blown into the rosin, shall not exceed 220°, or 225° Fahr.; whereas, after the volatile oil is distilled off, the temperature of the steam for clearing the rosin must not be much less than 250° Fahr.

With reference to the first part of the invention, the patentee claims the use of superheated steam, either alone, or in combination with common steam, in the distillation of turpentine and other resinous substances, and in clearing the rosin, so as to bring it into a marketable state, as above described.

The second part of the invention relates to the employment of heated air, as a substitute for steam, in the distillation of turpentine and other resinous matters, as described above. When air is employed, it is forced, by means of a force-pump, worked in the usual manner, through a pipe or coil of pipes, arranged in a furnace or otherwise, and heated up to a red heat or other requisite temperature, as in the case of the superheated steam. The air heated by its passage through this pipe is applied to the distillation of turpentine and other resinous substances, and to the clearing of the rosin, exactly in the manner already described in reference to steam, and by means of similar apparatus in either case; and being allowed to escape from a perforated pipe, and blow through the contents of the still, as in the process already described, it will be found that the heated air will operate precisely in the same manner, and produce upon the turpentine and rosin the same effect, as the superheated steam.

When using steam and hot air in combination, the steam is employed for the first part of the distillation process; that is, for the separation of the volatile essential oil or spirit from the rosin or solid matters; and then the heated air is applied for the purpose of clearing or clarifying the rosin, as already described.

The patentee claims, under the second head of his invention, the use of heated air as a source of heat, applied through the medium of any convenient apparatus, in the distillation of turpentine or other resinous matters, and in the place of, and as a substitute for, the furnace and open fire, as at present employed.

---

*To MATTHEW ANDREW, of Hyde, in the county of Chester, clerk, for certain improvements in fastenings for windows.*

—[Sealed 21st January, 1853.]

THIS invention of improvements in fastenings for windows relates, principally, to fastenings for what are commonly called "sash windows," constructed with one, two, or more sliding sashes,—two being the ordinary number. The invention consists in the application to such windows of certain self-acting mechanical apparatus, which, upon the closing of the window, draws the two sashes of the same into close contact, and effectually secures them; thereby simultaneously preventing draft and shaking of the sashes, and also keeping the same closed until released by hand. The self-acting mechanical apparatus may be constructed in a variety of forms, but



the most simple and economical is arranged as follows :—One part or sash of the window is furnished with an inclined plane or projection, over which an inclined loop or staple falls upon the closing of the window ; the action of these two inclined planes bringing the two sashes of the window into close contact. The staple is provided with a small spring-bolt that shoots into a catch or notch formed upon or in the inclined projection ; thus securing the two sashes until the bolt is withdrawn by hand ; or (if preferred) the spring-bolt may be attached to the inclined projection, and the catch or notch be in or upon the staple. This is all the apparatus that is necessary, provided that the sashes have no transverse sash-bars or other similar transverse projection. Where the reverse is the case, it is necessary that the projecting staple and its appendages should be mounted upon slides, being so constructed and acted upon by a spring as to slide back out of the way upon passing any of the sash-bars or projections, and return to its original position immediately after having passed the same.

In Plate VI., three separate modifications of the invention are represented. Fig. 1, represents, in sectional elevation, the most simple arrangement of the apparatus for windows having no transverse sash-bars or other similar transverse projections. *a, a*, is the lower frame or bar of the upper sash of a window, and *b, b*, the upper frame or bar of the lower sash. Upon the frame or bar *a*, the inclined plane or projection *c*, is fixed by screws or otherwise ; and upon the frame or bar *b*, the inclined loop or staple *d*, is fixed by screws or otherwise. This inclined loop or staple *d*, which projects over the inclined plane *c*, is furnished with a box *e*, containing a bolt *f*, which is pressed forward by means of a spring *g*, but which may be withdrawn by means of the projecting finger-piece *h*. The inclined projection *c*, is also furnished with a notch *i*, into which the bolt *f*, projects. Upon closing the window, the action of the two inclined planes *c*, and *d*, draws the sashes into close contact with each other,—the spring-bolt *f*, shooting into the recess *i*, and permanently retaining them in that position until released by hand. When it is desired to open the window, it is merely necessary to withdraw the small bolt *f*, and it will be found that the upper sash can then be lowered, or the lower sash raised.

Fig. 2, represents a modification of the above. The same description and letters of reference will answer for the principal parts of this arrangement as for the preceding. It will be seen, however, that the projecting staple or loop *d*, is not,

in this instance, a fixture, but is capable of moving in slides *e*, (see fig. 3, which is a front elevation of the apparatus), being pressed forward by the same spring *g*, which acts upon the bolt *f*. This arrangement, and the double incline or curved form of the face of the said staple, cause it to be moved backward by any transverse projection with which it may meet, and to return into its original position immediately after passing the same.

Figs. 4, and 5, represent similar views of another modification of the invention, the principal feature in which consists in a spring-catch *f*, which is substituted for the bolt, and which projects over the top of the staple *d*, when the window is closed.

The patentee claims bringing together, and keeping in close contact, the two parts or sashes of windows, and securing the same by self-acting means or apparatus, as above described and shewn; that is, without the use of the hand, except for the purpose of closing the window.

---

To WILLIAM HAMMOND SMITH, of Gloucester-row, Walworth, in the county of Surrey, for improvements in the manufacture of parchment.—[Sealed 2nd June, 1853.]

THIS invention consists in a new mode of preparing skins for converting them into parchment; the object being to give to parchment a whiter color and smoother surface than is obtained by the modes hitherto practised; and further, by such new mode or process, the parchment is entirely freed from grease, and thereby rendered capable of being written upon on both sides thereof equally well.

The skin to be operated upon is first stretched in a frame, and subjected to an operation technically termed "filling," and commonly practised by parchment manufacturers. It is then scalded to free it from grease, and the faces of the skin are afterwards rubbed (while wet) with whiting. The skin is next subjected to the ordinary operation of shaving, and is afterwards rubbed on each side with pumice stone and whiting, to give it a face; and, finally, a composition of French chalk, whiting, and size, is applied to the skin in a similar manner and for a similar purpose to that ordinarily employed in the manufacture of writing vellum.

The patentee claims the treating and preparing of skins, and the converting of them into parchment, in the manner and by the means hereinbefore particularly described and set forth.

To RICHARD ARCHIBALD BROOMAN, of *Fleet-street*, for *improvements in the manufacture of paper*,—being a communication.—[Sealed 10th June, 1853.]

THIS invention consists in manufacturing paper from wood reduced to small fibres or particles, which are obtained by some mechanical agent acting on the wood in the direction of the grain thereof and parallel therewith; the wood being held in every case so as to present the grain in the direction of its length to the reducing agent, and a current or stream of water being applied to the reducing agent just before contact with the wood or woody substance operated on.

The machinery preferred to be employed for the purpose of obtaining the fibres of wood and woody substances consists of a millstone or millstones, or metal rollers, cylinders, or rasps with roughened surfaces, which are caused to act upon blocks or pieces of wood held in a frame always in the direction of the grain thereof, as above-mentioned,—a current or stream of water being directed on to the stone or other reducing agent immediately before its contact with the wood. A gauge is provided to prevent the passage, with the water, of such portions of the wood or woody fibres as may not be sufficiently reduced. The fibres come from the stones, rollers, cylinders, or rasps, in a state of pulp, and are passed through sieves of different gauges, from which they are taken to be applied to the manufacture of different qualities of paper. The pulp thus obtained may be mixed with rag pulp, and with various other ingredients now employed in the manufacture of paper; and the pulp is to be submitted to the ordinary processes to which rag pulp is subjected to form it into paper.

In Plate VI., fig. 1, represents a vertical section of a machine suitable for reducing wood and woody fibres to pulp, for the manufacture of paper. The main part of this machine consists of a circular millstone or cylinder of steel, iron, or other metal, having a rough surface, and fixed in a vertical position on a shaft which revolves in suitable bearings. *a*, is the millstone, and *b*, the shaft on which it is fixed, turning in bearings *c*, which rest on beams or on a stone or iron foundation. The millstone turns in a box or casing *a*<sup>1</sup>, the under part of which is provided with an outlet *h*, for the ground pulp. The speed at which the millstone is driven is preferred to be from 180 to 240 revolutions per minute, when it is about 4 feet in diameter. The upper part of the casing *a*<sup>1</sup>, enclosing the millstone, has an aperture, in which is placed the frame *d*, which is open at bottom, and the four extremi-

ties of which come nearly in contact with the millstone. At one side of this frame is formed a perforated compartment *e*, which is intended to receive the water required to wet the millstone and mix with the fibre to form pulp; and on the other side of the frame and opposite to the compartment *e*, is fixed within the frame an iron or steel gauge-plate *g*, which nearly touches the stone, and is intended to prevent any large particles of fibre, which have not been sufficiently reduced, from passing into the outlet *h*. This gauge-plate can be raised or lowered by hand, or by tappets, or other suitable contrivances, according to the extent required, to suit the material operated on. The wood or woody substance to be reduced to pulp is placed with its fibres running in the same direction as that in which the millstone revolves, as before particularly directed, and as shewn in the detached view, fig. 2. This arrangement is absolutely essential, as upon it depends entirely the production of fibrous pulp suitable for the manufacture of paper. The wood is cut into suitable lengths, which are put into the frame *d*, in the position described, and pressed down or held with the grain of the fibre parallel to the direction in which the stone rotates, by a lever and weights, or by any other convenient means, on the grinding cylinder. The fibres, when separated from the wood, are carried away by the streams of water, and, passing downwards, escape through the outlet *h*, into a vessel *i*, which is furnished with a partition *k*; and after having passed the partition *k*, they flow gradually into a sieve *l*, which, by means of tappets *z, z*, is jogged or shaken, in order to separate or divide the finer from the coarser particles of the pulp. The finer particles, in the same way, pass again into a sieve *m*, where a second separation takes place; and, proceeding onwards, they are allowed to flow under the sieve *n*<sup>1</sup>, which allows water to escape, and from whence the fine pulp is conveyed into the reservoir *n*<sup>2</sup>. The separation may be carried on to a greater extent, as may be found requisite. The sieves are of different gauges, from coarse to fine. The different qualities of pulp thus obtained may be employed for the manufacture of paper of different qualities, alone, or mixed with any pulp of the sort ordinarily used, and with such other ingredients as are generally employed in manufacturing pulp into paper. The wood pulp may be bleached by any ordinary process, or by means of the following process:— Mix the pulp, in the first place, with a solution of carbonate of soda or soda ash, and, subsequently, with a solution of alum; the strength of these solutions being regulated by the degree of whiteness required to be given to the pulp. The

relative proportions of the two chemical bodies in their respective solutions are as about two to one; that is, the quantity of carbonate of soda contained in its solution should be about double the quantity of alum contained in the solution of that salt. The total quantity of both required is about one-tenth by weight of the pulp operated on.

The patentee claims, First,—the manufacture of paper from wood and woody fibres, reduced to fibrous pulp by means of mechanical agents acting in the direction of the length or grain of the said fibres, and parallel thereto; together with water or other suitable liquid, applied in the manner hereinbefore described. And, Second,—the particular arrangement of machinery represented in the drawing, and hereinbefore described, for reducing wood to fibrous pulp suitable for the manufacture of paper.

---

*To JEAN DURANDEAU, jun., of Paris, for certain means of obtaining marks and designs in paper.*—[Sealed 3rd June, 1853.]

THIS invention consists in transferring marks on to paper during the process of satining. The mark or design desired to be obtained on the paper, and the engraved plate, is passed, with the satining metallic sheets, between the cylinders of a laminating machine, the pressure of which causes the metallic sheet to penetrate into the hollow of the engraving, and form a relievo on the metallic sheet. It is easy to understand that, by passing, one after the other, through the laminating machine all the satining metallic sheets, with the engraved plate, each sheet will receive the same impression, and each sheet of paper satined by means of these plates will have, in its thickness, exactly the same design and at the same places. This small metallic relievo being solid, and taken in the thickness of the satining metallic plate, will be firm and lasting; thus the satining plates will be durable, and there will scarcely be any increase of expense. By this process the satining takes place according to the ordinary method; that is to say, by passing between smoothing cylinders packets of sheets of paper alternately with sheets of zinc bearing the designs in relief; and after this the reliefs become impressed in the sheets of paper.

The patentee claims the means above described of obtaining upon paper manufactured mechanically and in a continuous manner, marks, engravings, and designs, similar to those ob-

tained by the aid of water-marks in paper made by hand; these designs being obtained during the operation of satining, as above described.

---

*To JAMES LOVELL, of Glasgow, Gent., for improvements in heating and ventilating.*—[Sealed 25th May, 1853.]

THIS invention has for its object the generation of heat, and its transmission to the interior of buildings, concurrently with the abstraction therefrom of the impure heated vapour, and its passage out of the same, in such a manner as to maintain a constant circulation of fresh air therein. And this object is accomplished by means of apparatus, consisting of a furnace or fire-place, communicating with a heating-chamber, in which is contained another chamber, with a down-cast and up-cast shaft for the passage of impure heated air into and out of it. There is also a cold-air drain for the admission of fresh external air into the heating-chamber. The heat, as it passes from the furnace into the chamber, is, in a great degree, absorbed by the inner chamber; and, by means of this concentration of heat, the impure heated air or vapour is drawn into the latter, from the floor of the building, by the down-cast shaft, and is discharged by the up-cast shaft,—the fresh external air entering the heating chamber, and, after becoming heated, being made to pass into the building through any convenient openings in the floor.

In Plate VI., fig. 1, is a vertical section, and fig. 2, a front elevation of the heating and ventilating apparatus, supposed to be applied below the floor of a building; and fig. 3, is a vertical section, and fig. 4, an elevation of the ventilating apparatus or chamber, shewing the connection therewith of the down-cast and up-cast shafts. *a*, is the brickwork, enclosing the heating-chamber, and containing the fire-box or furnace *b*. This fire-box is lined with fire-brick, and is extended upwards at *c*, where is inserted a series of pipes or tubes *d*, passing into the heating chamber *e*. These pipes may be arranged as shewn, or otherwise, as preferred, and may be varied in size and number. The ends furthest removed from the furnace are inserted into a close box *f*, between which and the furnace is fixed another box *g*; and between these two boxes is fixed the ventilating-chamber *h*, containing within it a series of pipes *i*, the number and size of which may be varied. The box *g*, is in communication with the flue *j*, leading to the chimney. *k*, is the down-cast shaft for the passage

of impure heated air from the building into the chamber *h*; and *l*, is the up-cast shaft for passing the same out into the external air, at an elevation. *m*, is the conduit or inlet for fresh external air, through which the air may be introduced into the chamber *e*, from any convenient spot,—the conduit or inlet being adapted to the particular locality. *n*, is the flue for the passage of the hot air from the chamber *e*, to the building, the admission of which may be regulated as desired; and there may be several openings in the floor of the building, through which the heated air may be admitted, so as to distribute its effects over the area of such floor and building. *o, o*, are openings from the heating chamber *e*, into the upper part of the furnace *b*.

The operation of the apparatus is as follows:—The heat from the furnace passes up the extended portion *c*, and along the tubes *d*, into the close box *f*, whence it is returned through the tubes *i*, in the ventilating chamber *h*,—the smoke and noxious vapours passing through the box *g*, into the flue *j*, leading to the chimney. By this means the heat is communicated to the chamber *e*, by radiation, from the tubes *d*, box *f*, and ventilating chamber *h*; so that the fresh air, on its introduction to the said chamber *e*, by the inlet *m*, will become heated, and pass, in a heated state, out of the chamber through the flue *n*; whence it is conveyed to the building in any convenient manner. At the same time the required circulation of air is kept up by means of the chamber *h*; in which there will be a considerable amount of heat concentrated, so as to draw the impure heated air or vapour from the floor of the building by the down-cast shaft *k*, and discharge it up the up-cast shaft *l*,—the air or vapour, entering the shorter leg *k*, of the syphon, being thus passed through the ventilating chamber *h*, and carried up the longer leg *l*, and so discharged at an elevation. The current of air, thus produced, may be regulated by a self-acting damper, of any suitable construction.

The patentee claims the adaptation of apparatus for heating and ventilating by means of a fire-proof chamber, containing a heating apparatus, and receiving constant supplies of fresh external air; such chamber containing also a ventilating chamber, with down-cast and up-cast shafts, as described.

---

To RICHARD ARCHIBALD BROOMAN, of *Fleet-street*, for *improvements in the treatment of wool and silk, and in machinery for preparing silk so treated,—being a communication.*—[Sealed 26th August, 1853.]

THIS invention relates, firstly, to the treatment of animal wool. As in some cases it is highly desirable to scour the wool without the application of heat, the inventor employs for that purpose a sufficiently weak solution of caustic alkali, through which the wool is passed, and in contact with which it is agitated as long as necessary; or, he adds to the soap-water, employed for scouring the wool, a small quantity of caustic alkali in solution. In all cases the use of "butter-soap," made by the action of a caustic alkali on rancid butter, is preferred. After using the caustic alkali the wool is generally passed through a weak acid bath before final washing.

To prepare animal wool for dyeing, either alone or in combination with flax, hemp, jute, cotton, phormium tenax, or other vegetable fibre, it is dipped, either alone, or when mixed with the vegetable fibres, first in a weak solution of caustic alkali, and then in some acid; unless, in the subsequent operation of dyeing, the color or mordant should possess decidedly acid properties.

It is found that "picric," or carbazotic acid and its salts, are excellent mordants for animal wool, when mixed with vegetable fibre.

To prevent the milling or felting of wool after scouring, and at the same time to open and bleach it to a certain extent, it is dipped (after scouring, either in the ordinary way or according to the methods described above,) in a solution of some carbonate or other gas-yielding salt. It is then immersed in acid, such as weak sulphuric, so as to liberate carbonic acid or other elastic gas.

Secondly, the invention relates to the treatment of animal silk. In the treatment of certain descriptions of silk, such as cocoon silk, wild silk, &c., it is found useful to boil it with a small quantity of caustic alkali, and afterwards to add butter-soap or other soap, to which is also added a small quantity of caustic alkali. After boiling, in order to open the cocoons, the inventor employs the process of gaseous expansion, by the decomposition, for instance, of a carbonate by means of a weak acid,—the liberated gas separating and bleaching the animal fibres. He sometimes uses an acid salt, such as alum or the sulphate of alumina, to decompose the carbonates.

For opening and preparing the descriptions of silk above



mentioned, machinery similar to that employed for carding tow is used.

The figure in Plate VI., represents, in sectional elevation, a machine well adapted for opening, cleaning, and dressing the descriptions of silk above referred to. It consists of a large cylinder *a*, covered with card-cloth, having straight and pointed teeth of the size ordinarily employed on tow cards. Placed so as to work sufficiently near to the large cylinder is a smaller one *b*, covered also with cards of a similar description to those on the large cylinder, and working in the same direction, but at a different speed. The cocoon silk is laid on the endless apron *c*, *c*, moved by the rollers *d*, *d*, and is drawn between the fluted rollers *e*, *e*, from whence it is caught by the cards on the revolving cylinder *a*. After passing over the cylinder the silk is conveyed to the rollers *f*, *f*, and is deposited on the apron *g*, *g*, in a prepared state.

As a dressing for silk a soap is employed, formed of wax or stearine, which is afterwards to be decomposed in the fibre by means of any description of acid, capable of acting on it without injuring the silk.

The patentee claims, First,—the employment of caustic alkaline solutions for scouring animal wool, and the addition of caustic alkali to soap solutions employed for the like purpose. Second,—the preparation of animal wool, alone or mixed with vegetable fibres, for dyeing, by immersing it in a caustic alkaline solution, and subsequently in acid, or an acid solution. Third,—the employment of picric or carbazotic acid and its salts as mordants for animal wool, mixed with vegetable fibres. Fourth,—the preparation of animal wool, after scouring, by immersing it in a solution of some carbonate or gas-yielding salt, and subsequently in an acid or acid solution. Fifth,—the treatment of cocoon silk, wild silk, &c., by boiling it in a caustic alkaline solution, with the subsequent addition thereto of butter or other soap, alone or mixed with caustic alkali; and the treatment of such silk, after boiling, by decomposing therein a carbonate or gas-yielding salt by means of an acid or salt having an acid reaction, such as alum or sulphate of alumina. Sixth,—the machinery for opening and preparing silk, represented in the drawing, and hereinbefore described. And, Seventh,—the employment, for dressing silk, of a soap formed of wax or stearine, which is decomposed in the fibre by means of an acid.

---

To JULIAN BERNARD, of Regent Street, in the county of Middlesex, gent., for improvements in stitching and ornamenting various materials, and in machinery and apparatus connected therewith.—[Sealed 31st December 1853.]

THIS invention relates, first, to the production, by means of machinery, of a peculiar kind of stitch, somewhat similar to that known as "herring-bone," which stitch is used for uniting materials and securing their edges; and also for ornamenting the same with what is termed the "diamond stitch." Secondly, to the production of another improved form of stitch, which is suitable for uniting and ornamenting materials and securing their edges, and is also applicable to button holes. Thirdly, to the production of another improved stitch, and part of the means employed therein, and which is similar, to a certain extent, to that known as crochet, tambour, or chain-stitch, but unlike it in so far that the tendency to unravel or come undone will be diminished or prevented entirely when the thread is pulled at either end. Fourthly, to a peculiar arrangement and construction of mechanism for "hemming" or securing the edges of materials. And, lastly, to placing or securing on one common bed-plate two or more sets of mechanism, each having independent needle mechanism for sewing or stitching.

The production of the diamond stitch is accomplished by imparting to the material to be stitched or ornamented an alternate lateral or side travel, in conjunction with a forward travel, which compound motion will have the effect of presenting the material underneath the needle in such a manner as to produce the peculiar kind of stitch referred to. This result is obtained by imparting the compound motion to the friction band-wheel or other travelling means used for actuating or feeding in the material. The lateral motion is obtained from a bell-crank or other lever actuated by a circumferentially double-grooved cam, which is fitted with a moveable catch or director, to direct a stud into the end of the lever into each groove alternately for every revolution of the cam. The other end of the lever is connected to a sliding-plate working in grooves in the bed-plate of the machine; and through suitable slots in this plate is passed the friction-band or wheel for actuating the material. It thus obviously follows that by imparting a slight lateral movement to the plate, a corresponding lateral motion will be communicated to the friction-band or wheel, which will thereby bring the material into the proper position underneath the needle. In order to allow for

the lateral play of the plate, an elongated hole is made therein, through which hole the vertical needle passes on piercing the material. In Plate V., fig. 1, represents a plan of a portion of a sewing machine, with the arrangements hereinbefore described adapted thereto. *a*, is a portion of the bed-plate of the machine; and *b*, the moveable plate which gives the lateral motion to the feeding-wheel or friction-band *c*. This band is passed through slots in the plate *b*, and travels over its surface, being actuated by wide driving pulleys, not shewn in the drawing: or the pulleys or feeding wheel may slide upon fixed stud centres. *d*, is a bell crank-lever working on a fixed centre *e*, in the under side of the table or bed-plate. The extremity of the long arm of this lever is fitted with an antifriction pulley or stud *f*, which works freely in the grooves *g*, and *h*, of the cam *i*. This cam is carried on the driving-shaft, or any other suitable shaft *j*, of the machine, such shaft making one revolution for every insertion of the needle, and is fitted with a pointed moveable catch or director *k*, which turns on the centre *l*. This director serves to guide or direct the stud-pin of the lever *d*, from one groove of the cam to the other, as hereinafter explained. When the point of the director is on one side or other of the cam, the tail-piece *m*, will project slightly into one of the grooves, as shewn in the drawing; and as the cam revolves in the direction of the arrow, the protruding portion of the tail *m*, will strike against the stud *f*, of the lever *d*, which will by that means reverse the position of the director, by bringing it over to the other side of the cam, in which position it will remain until again reversed by the stud-pin *f*. It will thus be obvious that the stud *f*, will change from one groove to the other at each revolution of the cam-shaft, and will remain in such groove until the director comes round, and by its inclined edge pushes the stud-pin of the lever into the other groove; thereby giving an alternating lateral movement to the lever *d*; which motion is communicated to the plate *b*, by the short arm of the lever *d*, the pin *n*, of which works in a short slot in the plate *b*. *o*, is the needle, shewn in transverse section, working in an elongated hole in the plate *b*, to allow of its lateral traverse. In stitching or ornamenting materials by this machine, the needle *o*, with its thread is brought down by any suitable mechanism, and inserted into the material to be seamed or ornamented, which is fed in and held down by any suitable arrangement, and the stitches formed therein. The needle is then withdrawn, and the material is traversed forward and laterally; thereby bring-

ing a different point of its surface under the needle, which again descends and rises: the material is again moved forwards, and laterally, according to the extent of the stitch to be produced, and the needle is again inserted, and the movements continued. The stitch shewn in the diagram, fig. 2, is the stitch produced by this machine.

The patentee remarks, that he has not considered it necessary to shew any complete arrangement of sewing machine, as it will be obvious to the practical man that the arrangement shewn in fig. 1, may be readily adapted to the sewing machines at present in use; this peculiar mechanism being thrown out of gear, when not required, by withdrawing the stud-pin which works in the plate *b*, or by a clutch in connection with the cam *i*.

He further states that, although he prefers the cloth or material to move laterally under the needle, he does not confine himself to this particular mode of producing the stitch, as a lateral motion may be given to the needle instead of to the material. He claims, under this head of his invention, the peculiar stitch described and illustrated, whether such stitch be formed by a primary thread looped with itself, or secured in connection with one or more threads.

In carrying out the second head of the invention, namely, the securing of the edges of materials and button-holes, which is effected by either one or more threads, the thread is brought in a double or looped form from the one side of the material to the other side, so as to overlap the edge and insert the needle into the loop which is thus turned over. This loop, in one arrangement wherein two threads are employed, is obtained from a second thread, which is passed by a suitable instrument or " opener " through the loop formed in the needle thread under the material to be ornamented or secured. The loop of the second thread is then caught by a forked instrument or " returner," which raises it above the edge of the material; and, when in this position, it is laid hold of by a spring rod or finger, which draws it over the material in readiness for the next descent of the needle. This finger is actuated by an inclined projection formed upon it, which projection is actuated by a slotted incline upon the needle slide; and as the needle descends, the finger takes the loop from the forked instrument or returner, and draws it over the edge of the material just previous to the entrance of the needle therein. The needle with its thread then descends and passes through the loop so turned over and through the material. On the ascent of the needle, the incline on the

needle slide moves back the finger in readiness to receive another loop from the returner.

Fig. 3, represents a sectional elevation of a portion of a sewing machine of a suitable construction; fig. 4 is a plan of the mechanism; and fig. 5, is a side view of the returner, detached. *a*, is the bed-plate of the machine, supporting the bracket *b*, which carries the needle slide *c*. To the front of the bracket is secured the finger *d*, which serves to throw the loop over the edge of the material, and has an outward motion imparted to it by means of the incline *e*, in the needle slide. *f*, is the returner, which is carried on one end of the lever *g*, working upon the fixed centre *h*, attached to the bed-plate of the machine. The tail of this lever is actuated by the cam *i*, on the driving shaft *j*, and a vertical movement is thereby given to the returner. The opener *k*, carries the second thread, when two threads are employed, and is attached to the horizontal slide *l*, in the bed-plate, and is actuated by means of the cam *m*, and stud *n*. A small pin *o*, in the upper side of the opener, serves to impart to it a partial circular or curvilinear traverse, by sliding alternately along one side or the other of the catch *p*, which is kept pressed against the ledge *q*, by the blade-spring *r*. This partial circular traverse of the opener is for the purpose of placing the overlapping loop on the end of the returner, which has previously come into a proper position to receive it.

The action of this machine is as follows:—The thread being passed through the needle *s*, and its end being secured to the material to be stitched or ornamented, the needle is inserted through the material until a sufficient length of its thread is passed through to the other side to form a loop, through which loop is passed the end of the opener *k*, with its thread. When the opener is moved forward to enter the loop of the needle, its pin *o*, slides between the fixed ledge or guide *q*, and the spring-catch *p*, which latter it opens, and on its return slides up the inclined end *t*, of the catch, and returns along the outside of the same; the inherent spring in the shank of the opener allowing of such lateral movement. By the lateral motion just described, the thread of the opener is passed round the forked top of the returner *f*, in the form of a loop; the needle *s*, is then drawn up or out of the material, as shewn in the drawing, and the loop of the second thread, already formed, is at the same time drawn up or above the edge of the material by the ascent of the returner. The needle then begins to descend again, and in its descent, but before reaching the material, it draws down the inclined

projection *e*, and thereby allows the finger *d*, by its inherent spring, to move forward, and, by passing its point under the thread between the forks of the returner, take the loop therefrom; which loop it lays over the edge of the material, and there holds it until the needle has passed through it, and through the material, and again ascended. The ascent of the needle, by the aid of the projection *e*, and bend *e*<sup>1</sup>, in the finger, brings the finger back again to the position shewn in the drawing, in readiness for another loop, which it takes just previous to the entering of the needle point into the material. The needle is supplied with thread from the bobbin *u*, on the bracket *b*; and the opener from the bobbin *v*. The form of stitch produced is represented in the diagram, fig. 6. In performing this stitch by means of one thread only, a slight modification merely is requisite in the form of the end of the opener, which is shewn in fig. 7, where a small horn or projection *a*, is formed thereon. In this case the opener of course does not carry a thread, but merely enters the loop of the needle thread, and by its lateral or partial circular motion expands the loop, and admits of the entrance of the returner therein. This loop is then carried up by the returner and laid over the edge of the material by the finger *d*, in the manner before described; and the needle *s*, is then passed through it, and through the material, where a second loop is formed. Fig. 8, is a diagram plan of this one-thread stitch, shewing one side thereof: the other side resembles the side of the two-thread stitch, shewn at fig. 6.

In regard to this portion of his invention, the patentee claims the securing or ornamenting of "button," "lace," or other "holes," or the edges of various materials, or securing or uniting materials by their edges by means of one or more filaments; such filament or filaments being doubled or formed into a loop on one side the material, and secured on the other.

In the carrying out of the third portion of the invention, which consists of another improved form of stitch for uniting or ornamenting materials, similar to the ordinary crochet or chain stitch, but with the advantage of not having so great a tendency to become unravelled, one or more threads are employed, in conjunction with a straight needle, and a revolving hooked instrument, which latter is for the purpose of taking the loop from the needle, and, by its revolution, giving one or more turns or twists to the loop before the needle is re-inserted. The increased friction that will by this means occur, in attempting to unravel the thread from the material, by drawing either end, will greatly add to its security and

durability, and the appearance of the stitch, moreover, will be improved by the twisting of the loops in the manner hereinbefore described.

Fig. 9, represents a side elevation and partial vertical section of a compound sewing machine, in which at one end *A*, of the bed-plate, is represented the mechanism for effecting the improved crochet-stitch, and at the other end *B*, the mode of accomplishing the hemming or sewing of the edges of materials is represented. *a, a'*, is the common bed-plate of the machine, which is fitted with the pair of arms or brackets *b, c'*. The bracket *b*, carries the needle slide *d*, which is broken away at the top. The hooked instrument *e*, represented in detail, in side elevation, and plan, at figs. 10, is carried by the horizontal slide *f*, (see the plan view, fig. 11), which works in a suitable groove on the under side of the bed-plate, and is actuated by a cam, or excentric *g*, on the main shaft *h*. The shank of the hooked instrument *e*, has a grooved boss *i*, formed upon it, which fits into the end of the slide *f*, and is retained therein, but allowed to revolve freely, by a small pin *j*. The lever *k*, which transmits motion to the slide *f*, from the cam *g*, works on the fixed centre *l*, and is fitted with an India-rubber or other spring *m*, for the purpose of keeping the pulley *n*, against its cam. The rotatory motion of the hooked instrument is obtained from the rack *o*, and pinion *p*; the latter being either fixed on to the shank of the hooked instrument, and made wide to allow of its longitudinal traverse, or made to work on a feather in the shank *i*; in which case it would not require to be wider than the rack itself, as it would always remain in the same position, whilst the hooked instrument would traverse backwards and forwards through it. The rack *o*, which is fitted with a vertical stud *q*, is actuated by the cam *r*, and works in a groove in the bed-plate. This cam works against the stud *q*, so that, by its revolution, a to-and-fro sliding motion is communicated to the rack, a spring, which is not shewn in the drawings, being employed to return it. As the teeth of this rack gear into the pinion on the shank of the hooked instrument, it obviously follows that a rotatory motion will be given thereto, which may be caused to make one or more revolutions at each stitch, and consequently give one or more turns or twists to the loops previous to their being secured by the needle, according to the design of the cam *r*. In stitching by this mechanism, the needle *s*, with its thread is inserted through the material by any suitable mechanism; such, however, forming no part of the present invention. The needle is then drawn up

slightly so as to form a loop on the under side of the material, and this loop is caught by the hook *e*, previously in a position to receive it, as shewn at fig. 3. On laying hold of the loop, the hook commences to revolve; the needle then rises out of the material, and the material is advanced a short distance by any suitable well-known feeding mechanism, in readiness for the next succeeding stitch. The needle then descends again, and passes through the material, and through the loop last formed and twisted. In order that the needle may be certain of entering the loop, it is partially guided therein by a groove in the end of the hook, which is always vertical at the time of the descent of the needle. The hook now makes a slight turn, and simultaneously moves forward, thereby releasing the loop and passing beyond the needle to the position shewn at fig. 8, in readiness for taking a second loop. In order to pass beyond the needle, it is necessary that the hook should have a slight lateral motion, which it receives by the swell or incline *u*, on its shank acting against the fixed pin *w*,—the inherent spring in the shank allowing of such lateral motion. A diagram plan of this stitch is represented at fig. 12. The patentee claims, under this head of his invention, the production of an improved chain or tambour stitch, by twisting the loops more or less.

In carrying out the fourth part of the invention, namely, the hemming or sewing the edges of materials, a sliding metal blade or bar, having a rounded edge, and fitted with pins or points on its upper and lower surface, for the purpose of holding the material to be hemmed, is employed. This blade is laid on to the material, the edge of which is turned over on to the upper surface of the blade, and is caught by the pins or points before mentioned, which retain the material in the third position. The material is then turned back again so as to bring its extreme edge slightly over the edge of the blade. In this state the work is ready for the needle, which passes directly (either vertically or horizontally) through the slightly overhanging edge of the blade,—thereby effectually uniting the two portions of the material. The blades may be made either straight or curved, according to the form or contour of the hem; and the requisite traverse for the length of stitch may be obtained by any convenient feeding mechanism. The blade is guided during its traverse by a pair of fixed arms immediately over the bar, and fixed in any convenient part of the machine. These arms may be forked at one end, the forks embracing a projecting ledge or rail formed on, or attached to the upper surface of the blade; or, in place of



forks, and a guide rail, a slot may be formed in the blade, in which slot is fitted a fixed stud-pin, or antifriction pulley. In cases where a curvilinear motion is required, the guiding rail or slot is correspondingly curved.

The end *B*, of the bed-plate, in fig. 1, contains the arrangement for effecting the hemming or securing of material; the blades for holding the material, and the material itself, being represented in transverse section. *a*<sup>2</sup> represents the holding-blade, which is fitted with pins or sharp points. The material *b*, is laid upon the blade *b*<sup>1</sup>, and, being held by the points below the blade *a*<sup>2</sup>, it is turned over the rounded edge of the same, as at *c*, and is doubled back over the top of the blade *a*<sup>2</sup>, and there held by the points contained therein. A portion of the material is then doubled back again, according to the breadth of hem required; and its extreme edge is made to project slightly beyond the part turned over the rounded edge of the blade at *c*, and is held down by a second blade *d*. The needle first penetrates the top fold, and then passes through the turned-over portion of the material at *c*; but, in place of passing close up to the edge of the blade, it penetrates the centre of the thickness of the material,—thereby leaving no traces of the thread on one side of the material when finished. This is a great advantage in the sewing of various parts of garments; but in coarser and rougher work, or in many other fabrics, the needle may pass close up to the blade.

The patentee remarks, that he does not confine himself to any particular kind of stitch for sewing the edges, or hemming materials, as such may be secured by any suitable stitch; he has not, therefore, considered it requisite to shew any particular mode of stitching, but prefers using, for this purpose, either of the stitches represented at figs. 6, and 8, which are well adapted for hemming materials. He claims, under this head of his invention, the peculiar mode of doubling and holding the material for the purpose of hemming the same, and the means employed therein.

The sixth and last head of the invention, namely, the effecting of two or more kinds of stitching on one bed-plate, with distinct needles and needle mechanism, is clearly illustrated in fig. 9; wherein a portion of the hemming-machine *B*, and a portion of an improved crochet-machine *A*, are both fitted on to the one common bed-plate *a*,—each machine having fixed a special needle mechanism or holder of its own. But a double set of any of the well-known arrangements for stitching may be set upon, or secured to, one common bed-

plate, and may be connected, by gearing, to a driving apparatus, common to both, without such being a deviation from this part of the improvements, which the patentee declares to consist of placing or securing two or more, or parts of two or more, stitching or sewing mechanism to or on one frame or bed-plate, common to both.

---

*To JOHN CRABTREE, of Heywood, in the county of Lancaster, cotton spinner, for improvements in machinery for winding and doubling yarns.*—[Sealed 20th January, 1853.]

THIS invention consists in applying to the spindles of machines for winding and doubling yarn, a stop-lever or break, by means of which the spindles can be stopped individually for the purpose of piecing,—thereby effecting a great saving in time.

In Plate VI., fig. 1, is a sectional end elevation of an ordinary winding machine, with the improvements applied thereto; and fig. 2, is a plan of the same. *a, a*, are the cops, which are to be wound on the bobbins *b, b*. These bobbins are mounted on the spindles *c, c*, which are supported in foot-steps in the rail *d*, and in bearings in the bolster *e*. The yarn is guided from the cops *a*, to the faller *f*, and the spindles *c*, are driven by the drum *g*, in the usual manner. All the above-mentioned parts are similar to those in general use. The improvements consist in the lever *h*, and braids *i*, shewn detached at figs. 3, and 4. The braid *i*, is fast on the spindle *c*: it is furnished above with two projections, which enter into notches in the bottom of the bobbins in the usual manner; and the boss of the braid *i*, is flattened in two places, as shewn at fig. 4. The lever *h*, fits on a stud fixed in the bolster rail *e*, and is provided with a notch large enough to take on to the flattened sides of the boss of the braid *i*.

The mode of operation is as follows:—When the machine is at work, and the yarns are all in order, the levers *h*, are moved by the attendant into the positions shewn in the plan view, fig. 2, at the first, third, and fourth spindles; but as soon as an end breaks, or a fresh cop is required, the attendant moves the lever *h*, towards the bobbin, and brings the notch in the lever *h*, on to the boss of the braid *i*, as shewn in fig. 4, and in the second spindle of the plan, fig. 2. By this means, the motion of the spindle is arrested until the broken end is pieced, or a full cop substituted for the empty one: the band by which the spindle is driven slips on the wharve as long as the lever *h*, causes the boss of the spindle to be stopped,

but all the other spindles of the frame continue in motion. In winding-frames of the ordinary construction, it was necessary to stop the whole machine for piecing up an end; but according to this improvement, each spindle can be stopped individually, and the machine only requires to be stopped when the full bobbins are ready to be doffed; thereby rendering each frame capable of producing a much greater quantity of work than the frames of the ordinary construction. The patentee remarks, that he has not shewn the application of these improvements to a doubling frame, as any mechanic conversant with this class of machinery would be able to apply the improvements thereto.

He claims the application of the lever *h*, and flattened boss of the braid *i*, or any other equivalent agents, to the spindles of winding and doubling frames, for the purpose of stopping each spindle independently of the others.

---

To JAMES FRASER, of Gracechurch-street, merchant, for improvements in the manufacture of portable packages.  
[Sealed 21st March, 1853.]

This invention applies to trunks, boxes, cases, baskets, and packages of a six-sided figure, and is intended to render the same so portable as to occupy little more than the space of their own materials when such packages are empty.

The figure in Plate VI. is a perspective view of a square box or basket, partially open. The top *a*, and side *b*, are hinged together; and the side *b*, is fastened to the bottom *c*, by hinges. The remaining three sides *d*, *e*, *f*, are hinged respectively to the raised sides *a\**, *b\**, and *c\**, of the bottom *c*. Thus provided, *a* can be folded down on to *b*, and then these two turned down on to *c*; over these will fall the side *f*; then will follow the remaining sides in the order of *d*, and, lastly, *e*.

The patentee remarks that, in this arrangement, the three low fixed raised sides *a\**, *b\**, and *c\**, attached to the bottom piece *c*, are merely added to accommodate the lapping or folding of the top and four sides in a convenient manner, particularly when made of wicker work. Oblong boxes may be manufactured with top, bottom, and sides only,—the edges being bevelled, to allow their closing neatly. Such portable packages, when made of wicker work, can be provided with apertures for admitting cord, or other means of fastening them. Wood cases can have hasps, screws, or other convenient additions for security in closing them; and, in some cases,

stances, waterproof or other coverings of canvas, and the like, may be employed. When packages are constructed of sheet metal, leather, gutta-percha, or other like materials, the means of closing the sides will be conveniently provided out of their own substance.

The patentee claims the peculiar method described of constructing portable packages.

---

*To DAVID CHALMERS, of Manchester, manufacturer, for improvements in machinery or apparatus for cutting the pile of woven fabrics.*—[Sealed 18th August, 1853.]

THIS invention consists of an improved method of cutting the pile of woven fabrics by means of knives or cutters on a revolving roller or cylinder, acting on the face of the fabric so as to cut the raised threads intended to form the pile. The machine or apparatus consists of two rollers or beams, revolving in pedestals at each extremity of a frame,—one to contain the cloth or material to be cut, and the other to take it up as it is cut or finished. On the top of the frame are fixed two other rollers, nearly in contact, “through which the cloth passes; the bottom roller being plain, and the top one forming the knives or cutters.” As the cloth passes between these rollers, it comes in contact with a number of guides, to keep it in a proper position to be acted upon by the knives. Set screws are also placed at a short distance from the point of the guides, to keep the material to be cut in an exact position to be conducted by the guides. The rollers are driven at different speeds, and in opposite directions; the bottom one slower than the top one, which holds the cutters. The cutters on this top roller may be either cut out of the solid steel by means of a comb, or may be loose circular cutters keyed on the roller; but the former plan will be found preferable. The rollers may also be driven by separate driving pulleys, or otherwise.

In Plate V., fig. 1, is a section of the improved machine or apparatus; and fig. 2, is an end view of the same. *a*, represents the frame; *b*, the pedestals; *c*, the driving-pulleys; and *d*, the upper roller, with the knives or cutters, which roller is driven at a greater speed than the lower plain roller *e*. *f*, is the beam or cylinder containing the cloth or material to be cut; *g*, the beam or cylinder taking it up after it is cut; *h, h*, are set-screws, to regulate the position of the cloth; and *i, i*, guides, placed above the cloth, to guide it correctly to the knives or projections of the upper roller.

The patentee claims the construction and arrangement of the machinery or apparatus, as herein described, for the purpose of cutting the pile of woven fabrics.

---

*To* ROBERT CHRISTOPHER WITTY, of Portland-place, Wandsworth-road, engineer, for improvements in the construction of boiler and other furnaces.—[Sealed 6th Dec., 1853.]

THIS invention consists of a mode or modes of constructing boiler and other furnaces for the purpose of causing the smoke and other gaseous products, arising from the burning of coal in such furnaces, to be consumed, and thus preventing the smoke from passing into the chimney or atmosphere. For this purpose a perforated bridge is constructed at the end of the fire-bars, and a slide-door, or other convenient means, for closing the opening above the bridge. The bridge may be made of fire-brick or moulded lumps, or any other fit materials, constructed or put together in such a manner that the bridge shall have numerous passages through it for the smoke and other products arising from coal supplied to the fire to pass through, when the opening above the bridge is closed. The opening above the bridge is furnished with a sliding-door, or other convenient means, for closing it, so that it may be kept open for the passage of the products arising from the fire, at those times when the fire does not produce smoke: and the opening can be closed at any time, when, by reason of a supply of fresh fuel, or any other cause, smoke shall be evolved from the burning fuel. The door, or slide, may be made of fire-tile, or any other suitable material, so that it may be able to sustain the action of the heat to which it may be exposed. In using a furnace constructed in this manner, some of the thoroughly ignited fuel which has ceased to give out smoke, should be, from time to time, pushed back against, or near to, the bridge, so that the bridge may be made as hot as conveniently may be, for the purpose of heating the smoke and gaseous products which shall, from time to time, be caused to pass through the orifices or passages of the bridge: and when the fire is about to be supplied with fresh coal, or other fuel producing smoke, the passage over the bridge is closed; so that the smoke and other gaseous products arising from the fresh fuel in the front of the fire may, in their passage to the orifices or openings of the bridge, be caused to pass more closely over the top of the hot fire at the back of the furnace, and may then pass through the orifices or passages made

through the bridge; which, being highly heated by the previous action of the fire, will further contribute to raise the temperature of the smoke and other gaseous matters; so that, when they come in contact and become mingled with a supply of warm air admitted beyond the bridge for this purpose, the smoke and other products arising from the fresh fuel may be ignited and consumed, before they can reach the chimney or atmosphere. When the combustion of the fresh fuel has proceeded so far that it forms a portion of the bright fire, the passage over the bridge is again opened, so that the bridge may be again made very hot by the action of the bright fire.

In Plate V., fig. 1, shews a longitudinal section; and fig. 2, a transverse section of a steam-boiler furnace, with the invention applied thereto. *a*, is a bridge of fire-clay, having numerous orifices or passages through it; and *b*, is a passage for a supply of air from the ashpit to the back of the bridge. The orifices or passages through the bridge may be round, square, or any other shape which may be found most convenient in the manufacture, according to the material of which it may be made. *c*, is a slide or trap-door, by means of which the opening above the bridge, that is to say, the open space between the top of the bridge and the bottom of the boiler, may be closed. The slide is moved up or down by the levers *d*, *d*<sup>1</sup>, which are mounted upon the axis *e*. The further end of the lever *d*, is attached to a link *f*, which is connected with, and acts on, the slide. By this arrangement it will be seen, that if, before supplying fresh coals to the furnace, the slide *c*, is raised, all the smoke and gaseous products from the fire, in place of passing over the bridge, will pass through or near to the hot fire in front of the bridge, and also through the holes or passages in the hot bridge; and being thus highly heated, they will, upon coming into contact with the current of air behind the bridge, be in a better state for causing them to be more completely consumed. When a supply of fresh fuel shall have ceased to give out smoke, the slide *c*, is to be lowered, so that the bridge, after being cooled by the passage of the currents of smoke and gas through it, may become very hot, and be thereby in a better condition to heat the smoke and other products evolved from the next supply of fuel to the furnace.

The patentee claims the combination of a perforated bridge, and a door, slide, or stop, for the purpose of, from time to time, opening and closing the space, opening, or opening, above the bridge, in manner and for the purposes above described.

To SAMUEL NEWTON, of *Stockport, in the county of Chester, cotton manufacturer, for a self-acting friction brake, to be applied to engines, carriages, and waggons used on railways.*—[Sealed 29th March, 1853.]

THIS invention is intended to supply to each carriage in a train a self-acting means of sledging or stopping the revolution of each pair of wheels simultaneously, or nearly so, throughout the train; the apparatus for producing such effect being always ready to come into action on the pull of the draw-bar becoming slackened.

And this effect is accomplished by the adaptation and application to each axle of a friction-wheel, over which is suspended, or otherwise applied, a common "clamp-brake" (such as is ordinarily applied to cranes), in such a manner as to cause the brake to span or embrace the whole, or nearly the whole circumference of the friction-wheel, against which the brake is made to press by the action of a weighted lever. The tendency of this lever is to keep the clamp-brake pressing against the friction-wheel at all times, except when the weighted end of it is raised by the pull of the draw-bar,—so that the brake is always ready to come into immediate operation; and the same friction-wheel and brake being applied to the axle of every carriage in the train, and the carriages being all suitably connected together, all the brakes may be drawn off their respective friction-wheels by the draw-bars, and all brought into action, by slackening the speed of the engine, simultaneously, or nearly so, throughout the train.

The amount of force to be exerted by the weighted lever on each brake may be varied, but it should be so regulated that the pull of the engine required to draw the carriage into motion may be more than sufficient to raise the lever, and draw the brake out of action.

The figure in Plate VI. is a longitudinal section of the frame of a carriage, shewing the friction-wheel and brake applied to each of the axles; the brakes being represented as pressing upon the friction wheels. *a, a*, are the axles of the wheels; *b*, is the friction-wheel keyed on to the axle; *c*, is the clamp-brake, suspended over the friction-wheel at *d*, which is the centre of motion for the two clamps of the brake; and *e*, is the weighted lever, by which the brake is pressed against the friction-wheel. This lever turns on a fulcrum *f*, fixed in the frame or carrier *g*. The lower ends of the clamps *c, c*, pass through slots formed obliquely in the lever *e*; so that, when

the weighted end of the lever is raised, the effect will be to force the ends of the clamps outwards, and take off their pressure from the circumference of the friction-wheel. *i, i*, are two pulleys, mounted in any convenient manner underneath the frame of the carriage; over which pulleys chains pass from the weighted ends of the levers *e*, to the tail-piece *j*, fixed to the draw-bar *k*; so that when the draw-bar is pulled, it may draw the chain over the pulley *i*, and raise the weighted end of the lever. *l*, is a link by which the two draw-bars of the carriage are connected together; so that, should the bar be pulled from either end of the carriage, the effect will be to raise the central ring or uniting part of the chains, and with it the chains, carrying with them the weighted ends of both levers *e*. The draw-bar *k*, is fitted so as to admit of its being pulled a short distance in order to raise the levers *e*, and release the friction-wheels *b*, from the contact of the brakes, before it draws the carriage forwards. The dotted lines shew the position the different parts of the apparatus would assume when the clamp-brakes are not in action with the friction-wheels.

The action of the friction-brake is as follows:—Before the draw-bar *k*, is brought into tension, the brake is pressing against the friction-wheel; but the pull of the draw-bar raises the weighted end of the lever *e*, and depresses the reverse end. By this motion, the lever is made to act obliquely on the lower ends of the clamps *c*, and force them outwards. As soon, however, as the pull on the draw-bar ceases, the weighted end of the lever falls, and brings the clamps *c*, again in contact with the circumference of the friction-wheel *b*.

The patentee remarks, that the width of such circumference may be varied according to the amount of friction required to be produced thereon. In case, however, it should be found desirable, a strong spring might be substituted for the weighted lever, in order to bring the brake into action upon the friction-wheel.

For the purpose of repeating the arrangement to every carriage of a train, the several draw-bars are suitably connected together, so as to cause an uniform extent of motion throughout the train. Thus the draw-bars may be connected by means of a transverse-pin passed through ears on the ends of the bars, and thus form a kind of hinge-joint between them; but this mode of connection may be varied, provided uniformity in the movement of the several draw-bars is insured. The same friction-wheel and brake is also to be applied to the



axles on the engine and tender; but in this case, as well as in that of the guard's carriage, the parts should be so arranged that the brakes may be worked by hand, instead of being self-acting, as described.

In some cases it is usual to push the train a short distance by the buffer-rods, instead of drawing it by the draw-bars. In order, therefore, to meet such cases, one of the chains passing over one of the pulleys *i*, should be connected to one of the buffer-rods, by means of a lever, in such a manner as to provide an adequate leverage for raising the weighted ends of the levers *e*, or overcoming the elastic force of the spring (when such is used) within the range of action of the buffer-springs, before the carriage is set in motion.

The patentee claims the adaptation and application of the clamp-brake, combined with the friction-wheel, to railway carriages, so as to constitute a self-acting friction-brake for such carriage, in the manner described.

---

*To THOMAS HOLLINSWORTH, of Winwick, near Warrington, in the county of Lancaster, engineer, for certain improvements in the method of applying brakes to carriages employed upon railways, and in the machinery or apparatus connected therewith.—[Sealed 12th December, 1853.]*

THESE improvements in the method of applying brakes to railway carriages, and in the machinery or apparatus connected therewith, consist in the direct application and use of compressed air, at a high pressure, as the means of communicating action, when required, to railway brakes, either attached to or connected with the guard's brake van, or any or all of the carriages or tenders employed upon railways, in lieu of the mechanical gearing or other arrangements hitherto used for such purpose. The apparatus to be employed consists of an air-pump or pumps, of any ordinary or other construction, to which is attached a receiver or reservoir, into which the air is forced: the pumps may be worked either by an excentric or any other suitable motion from the axle of the guard's brake-van or any of the carriages, or by a mechanical arrangement independent of any motion obtained from the brake-van or any of the carriages. Connected with the receiver is a safety or discharge-valve, by which the superfluous air is emitted after the necessary or required pressure has been obtained. The communication between the air receiver and the brakes, may be made by means of a small cylinder and piston acting

upon levers, or by any more suitable arrangement, and the brakes may thus be instantaneously put upon the wheels, simply by opening the air tap or valve, and as readily removed by similar means

In Plate VI., fig. 1, represents a longitudinal sectional elevation of the framing of a railway carriage, with the improved apparatus fitted thereto; and fig. 2, is a plan view of the same, looking upwards from underneath the carriage framing. The pump *a*, is worked by the excentric *b*. At each revolution of the wheel (on the axis of which the excentric *b*, is carried) the air is forced by the pump *a*, through the bent pipe *c*, into the air-chamber or reservoir *d*, where it is retained until required for putting the brakes on. *e*, is the escape or safety-valve, and *f*, the cone plug or stop, which may be regulated, to maintain any pressure within the air-chamber, by screwing up the nuts and cross pieces *g*, and so compressing the springs against the shoulder of the stop *f*. The brakes *h*, and *j*, are shewn in fig. 1, as having locked the wheels. This has been effected by the action of the handle or arm *k*, (which, when the brakes are not in action, is in a perpendicular position,) being drawn a little on one side,—thereby acting upon the slide-box *l*, and cog-wheel *m*. The slide-box *l*, causes a partial revolution of the entire longitudinal rod *n*, continuing and connected throughout the whole length of the train, and operating upon a similar apparatus under every carriage, as will hereinafter be described in connection with the cog-wheel *m*. At the time of the partial revolution of the longitudinal rod *n*, the pinion *o*, receives a simultaneous action through the wheel *m*. The pinion *o*, is fixed on the barrel of a “three way” cock or tap *o*<sup>1</sup>, and in its partial revolution has opened the communication between the air-chamber *d*, and the cylinder *p*, open at one end. The atmosphere, in its course from the air-chamber, passes first through the pipe 1, next through the longitudinal tube 2, extending the entire length of the train, and thence through the bent tube or pipe 3, and into the closed end of the cylinder *p*. It will now be readily understood, that upon admission of compressed air into the cylinder *p*, the piston will be driven back, and hence the action on the brakes through the connecting rod *q*, and levers *r*, and *r*<sup>1</sup>, combined with the immediate connecting rods *s*, and *s*<sup>1</sup>, of the brakes *h*, and *j*. When it is necessary to release the wheels of the carriage, the arm or lever *k*, is brought back to its perpendicular position, and, acting upon the “three-way” cock, the communication between the air-chamber and cylinder is cut off; and the

third way or channel of the cock being brought opposite to the opening *u*, the compressed air is allowed to escape. The piston now being free, the brakes are thrown out of action by the counter-balance weight *v*. *w*, is a universal joint, which allows the longitudinal air tube (always charged) to communicate itself to any irregularity in the motion of the carriages; *x*, is a stop cock for the closing of the air tube when the carriages are taken from the train; *y*, is a hermetically-sealed slide-box, allowing the elongation or compression of the air tube, in accordance with the action of the buffers; *z*, is a screw connecting piece; and *a*<sup>1</sup>, a spring or catch on the longitudinal rod or bar *n*. When the carriages are brought together, the taper end of the longitudinal bar is placed within the block *a*<sup>2</sup>; the spring *a*<sup>1</sup>, immediately falls into its receiving slot, and the bar is connected throughout the entire length of the train. *a*<sup>3</sup>, and *a*<sup>4</sup>, are pivots allowing a similar action to the universal joint.

The patentee claims the novel and peculiar method of applying brakes to carriages employed upon railways, by means of atmospheric pressure, as herein particularly described and set forth, as well as the peculiar arrangement or combination of the several parts of the apparatus or mechanism employed for such purpose.

---

To JOHN HENRY JOHNSON, of *Lincoln's-inn-fields, Gent.*, for improvements in machinery or apparatus for cutting paper, — being a communication. — [Sealed 28th September, 1853.]

THIS invention relates to an improved arrangement of mechanism for cutting paper, consisting of a stand, containing a sliding platform, upon which the paper to be cut is compressed by a suitable pressing screw. The knife, or cutter, is carried in a moveable frame, and is made to traverse longitudinally and simultaneously with the platform, but in an opposite direction: thus the paper is drawn in one direction, and the knife, or cutter, in an opposite one,—thereby effecting a much greater accuracy and steadiness in the cut. The platform, upon which the paper rests, is moveable also, in a direction at right angles with its traverse: this is accomplished by a fixed screw and nut, and a suitable winch handle. This movement is for the purpose of regulating exactly the amount to be cut off from the edge of the paper,—the adjustment being regulated by a graduated pulley, or disc, on the axis of the actuating screw.

In Plate VI., fig. 1, is a front elevation of the machine; and fig. 2, is a vertical section, taken through the centre of the machine. Figs. 3, 4, and 5, represent details of the working parts of the machine; fig. 6, is a front view of the piece which serves to regulate the inclination of the table; and figs. 7, and 8, represent details of two arrangements for fixing the cutter.

The machine is composed of two cast-iron standards *A*, *A*<sup>1</sup>, connected by bolts, and resting upon the cast-iron supports *B*, *B*. Between these fixed standards *A*, *A*<sup>1</sup>, are fitted two moveable frames *c*, and *d*,—the upper one *c*, of which carries a cutter *c*, and the lower one *d*, supports the platform *E*, upon which is laid the paper to be cut. The paper is effectually held in its place by means of the pressing plate *F*, attached to the extremity of the double-threaded screw *G*, which is fitted with a small hand-wheel *H*, for giving the requisite pressure to the paper.

In order that the paper may be cut square, and to a certain determined size, a groove *e*, is formed in the table *E*, in which projects the under portion of the gauge *I*, having secured to it the nut *I*<sup>1</sup>, through which works the four-threaded screw *i*, actuated by the handle *J*. By turning this handle, the screw *i*, will be caused to rotate, and, consequently, the gauge *I*, will be caused to advance or recede, as the case may be. It is against this gauge that the sheets of paper to be cut to a certain length are placed. A pinion *j*<sup>\*</sup>, is fixed to the spindle of the screw *i*, and gears into the wheel *j*, which again gears into the internal teeth of the disc *K*. The external circumference of this disc is divided or graduated, so as to indicate by means of the index *k*, the number of turns of the screw *i*, or rather the distance between the gauge *I*, and cutter *c*, and, consequently, the length of the paper.

To obviate the defect of the greater portion of paper-cutting machines, namely, that of not cutting straight or in a perpendicular direction, the table *E*, is made adjustable, in order that it may be inclined according to the nature and thickness of the pile to be cut through. To effect this, a small swell *e*<sup>1</sup>, is cast upon the under-side of the table *E*, which rests upon a similar swell in the plate *d*, of the moveable frame *d*, so that the table *E*, rests only upon one point. Behind the plate *d*, is fixed the support *a*, shewn in detail at fig. 6. This support serves to carry the nut *a*<sup>1</sup>, through which works the screw of the fork *b*, jointed to the piece *b*<sup>1</sup>, which is screwed to the under-side of the table *E*. Thus, if the head *a*<sup>2</sup>, of the screw *a*<sup>1</sup>, be turned in one direction or the

other, the fork *b*, will be caused to ascend or descend with the table, which will, consequently, assume an inclined position, which is regulated by the set screws *f*. The machine being ready for work, and the paper placed in its proper position, the pulley *L*, is caused to rotate by a driving belt, or other arrangement. This pulley is keyed on to the shaft *g*, which also carries a clutch-box *h*, embraced by the fork *h*<sup>1</sup>, as shewn in figs. 3, 4, and 5. This fork is attached, at its extremity, to the curved piece *l*, and jointed at *h*<sup>2</sup>, for the facility of actuating the clutch acted upon by the cams or tappets *m*, and *m*<sup>1</sup>, which slide over the piece *l*, (fig. 5); or the short clutch may be actuated by the short lever *l*<sup>1</sup>, attached to the bottom of a spindle which works through the boss *l*<sup>2</sup>, cast in one piece with the standard or frame *A*<sup>1</sup>. To the upper end of this spindle is secured the bent lever *n*<sup>1</sup>, (fig. 1,) by which the clutch may be actuated by hand, although this operation may be effected by the machine itself, as hereinbefore described. When the machine is ready for cutting, the clutch, having been brought into position by the cam *m*<sup>1</sup>, will gear with the collar boss of the pinion *m*, (fig. 3,) which gives motion to the wheels *m*<sup>1</sup>, *m*<sup>2</sup>, carried by the spindle *m*<sup>\*</sup>. The wheel *m*<sup>2</sup>, gears with the wheel *m*<sup>3</sup>, keyed on to the small shaft *m*<sup>3</sup>, which carries also the small-toothed segment *m*<sup>2</sup>, gearing with the rack *m*<sup>4</sup>. This rack is bolted to the moveable frame *d*, which frame is connected to the frame *c*, by the links *d*<sup>1</sup>, and *c*<sup>1</sup>, and vibrating lever *c*<sup>2</sup>, working on a fixed centre at *d*<sup>2</sup>, which is cast in one piece with the frame or standard *A*, *A*<sup>1</sup>. By this arrangement, the two frames *c*, and *d*, are firmly connected together; and when one rises, the other descends; the movement of both being oblique, according to the angle of the slides, which guide the two frames, by means of the bolts *d*<sup>2</sup>. The two frames having arrived at the end of their course, at the moment that the cutter arrives at the surface of the table *E*, the cam *m*, on the toothed-wheel *m*<sup>3</sup>, will act upon the curved piece *l*, and cause the clutch *h*, to slide or disengage itself from the collar boss of the pinion *m*, and come into gear with the boss of the wheel *n*, which gears directly with the wheel *m*<sup>3</sup>. This wheel then commences to revolve in the contrary direction; thereby causing the table to descend, and the cutter to ascend with a quick motion. These movements will be readily understood on referring to fig. 1, wherein the black arrows shew the direction of movement which causes the cutter to descend, and, consequently, the table to ascend: and the dotted arrows represent the contrary movements, namely, the ascent of the frame *c*, which carries the cutter *c*,

and the descent of the frame *D*, carrying the platform *R*. The machine may be stopped by means of the bent lever *n*<sup>1</sup>, which is kept in the rest *o*, by the counter-weight *P*; thereby indicating that the clutch is out of gear, both with the pinion *m*, and wheel *N*. In order to adjust or regulate the height of the cutter *c*, as it wears away, it is attached to the frame *c*, by means of conical screws *p*, over which it slides by the slots *p*<sup>1</sup>. The regulating screws *q*, are tapped into the cutter *c*, (fig. 7,) or into the frame (fig. 8,) so as not to weaken the cutter. By turning these screws, the height of the cutter may be adjusted with great accuracy.

The patentee claims, First,—the general arrangement and construction of machinery for cutting paper, as hereinbefore described. Second,—the system or mode of cutting paper, by a double-sliding movement of the cutter and table in opposite directions, as hereinbefore described. Third,—the arrangement, hereinbefore described, for throwing the machine in or out of gear, and reversing its movements. Fourth,—the system or mode of regulating the incline of the table according to the nature and thickness of the paper to be cut, as hereinbefore described. Fifth,—the system or mode of adjusting and fixing the cutter, as hereinbefore described.

---

To JOHN PARKINSON, of Bury, in the county of Lancaster, brass-founder, for improvements in governors for regulating the pressure of steam, gas, and other fluids or liquids.—  
[Sealed 28th December, 1853.]

THE nature of this invention consists, first, in the application of a double compensating valve, acted upon by a flexible diaphragm, or other equivalent agent, for regulating the pressure of gas and certain other fluids or liquids; and, secondly, in an improved combination of parts for regulating the pressure of steam and certain other fluids or liquids, consisting of a double compensating valve and flexible diaphragm,—the latter being protected from the action of the steam or other fluid or liquid, the pressure of which is to be regulated by a column of water or other liquid.

In Plate VI., fig. 1, is a longitudinal section of a governor, particularly applicable for regulating the pressure of gas for illumination; and fig. 2, is a transverse section of the same. *a*, is the casing, to which is cast the branch *b*, for the supply-pipe, and the branch *c*, for the off-pipe; *d*, is a box containing the seatings for the compensating valves *e*, and *e*<sup>1</sup>, and

the passages *f*. These valves are either cast or otherwise fixed together, so as to ensure their simultaneous action. The lower valve *e*<sup>1</sup>, is somewhat larger than the upper valve *e*; but, when they are closed, the area of each valve, exposed to the action of the gas from the supply-pipe, is the same. *g*, is a spindle, attached to the valve *e*, and passing through a guide *h*. The upper end of the spindle *g*, passes through a thin metal disc *i*, to which it is attached by a nut. In the centre of the disc *i*, is a ferrule for holding the centre of the diaphragm *k*; the outer circumference of which is secured between the upper side of the casing *a*, and the flange *l*. The pressure on the diaphragm can be regulated by weights, one of which is shewn at *n*; and although it is preferred to make the diaphragm of vulcanized or mineralized India-rubber, other elastic materials, or thin metal, may be used. The lid *m*, (see fig. 1,) fits on the flange *l*, and can easily be removed, if it should be requisite to vary the weight on the diaphragm. At the under side of the casing *a*, is a small lid *o*, to which is fixed a pin *p*, which acts as a guide for the compensating-valve. The governor is placed in any convenient position between the gas-meter and the burners,—the supply-pipe from the meter being screwed into the branch *b*, and the off-pipe, which conveys the gas to the burners, into the branch *c*. As long as the governor is inactive, that is to say, that no gas is allowed to escape through the burners, both the valves are in contact with their seatings; but as soon as the gas passing through the burners is ignited, the pressure in the off-pipe is diminished: the weight on the diaphragm then instantly lowers the compensating valves *e*, and *e*<sup>1</sup>, off their seatings, and the gas passes through the openings *f*, into the branch *c*, to supply the burners. As long as the pressure of gas in the supply-pipe remains the same, the orifices between the valves and their seatings remain uniform; but when the pressure of the gas in the supply-pipe increases, more gas passes into the off-pipe, and increases the pressure on the flexible diaphragm *k*, which then rises, and brings the valves towards their seatings,—thereby reducing the orifices between the valves and their seatings, and diminishing the quantity of gas in the off-pipe. When the pressure of the gas in the supply-pipe diminishes, less gas passes into the off-pipe; consequently the pressure on the diaphragm is reduced, and the orifices between the valves and their seatings are enlarged. By this means the requisite amount of gas escapes to the burners; thereby maintaining a uniform pressure in the off-pipe and in the burners, notwithstanding the irregularities in the pressure on

the gas in the supply-pipe. The patentee remarks, that the spindle *g*, instead of being attached to the flexible diaphragm, as above described, may be attached to an inverted vessel, working in quicksilver or other fluid, in the usual manner. In this case the irregularities in the pressure of the gas would raise or lower the inverted vessel, and thereby act on the compensating-valves, so as to equalize the pressure in the burners, as before described.

Fig. 3, is a longitudinal section of a governor, particularly applicable for regulating the pressure of high-pressure steam. This governor, being similar, in many respects, to the one above described, is marked with corresponding letters of reference. To the lower part of the casing is cast or fixed the tube *q*, at the end of which is attached another tube *r*. Between the flanges of these tubes is the diaphragm marked *k*, as before. The lower tube *r*, contains a block *s*; against which bears the end of the wire *t*, which is screwed above to the spindle of the valves, and below to the diaphragm. The block *s*, bears upon the spring *x*, the tension of which can be adjusted by the thumb-screw *u*. The tube *q*, is partly filled with water or other fluid; the object of which is to prevent the steam acting direct on the flexible diaphragm *k*. The action of this governor is as follows:—If the steam in the supply-pipe is of the pressure, say, of twenty pounds on the square inch, and it should be requisite to reduce it to five pounds on the square inch, the attendant, by turning the thumb-screw *u*, regulates the tension of the spring *x*, until it is capable of resisting a pressure of five pounds to the inch. When this governor is inactive, that is to say, when no steam is escaping through the off-pipe, the compensating valves are closed; but, as soon as steam is drawn from the off-pipe, the action of the spring *x*, raises the valves off their seatings; thereby allowing a portion of steam from the supply-pipe to pass into the off-pipe. As long as the steam in the supply-pipe remains at the same pressure, the valves remain at the same distance from their seatings; but when the pressure increases in the supply-pipe, more steam passes into the off-pipe, and the pressure on the column of water or other fluid in the tube *q*, is increased. By this means the flexible diaphragm is depressed; thereby partially closing the orifices of the compensating-valves; but if the pressure in the supply-pipe is reduced, less steam passes into the off-pipe, and the spring *x*, causes the diaphragm to rise, and allows more steam to enter the off-pipe. By this arrangement the steam, in passing through the orifices between the compensating valves and their seatings, is more or



less "wire-drawn," and the pressure in the off-pipe is thus maintained uniform.

The patentee claims, First,—the application of a double compensating valve, acted upon by a flexible diaphragm, or other equivalent agent, as shewn and described in reference to figs. 1, and 2, for governing or regulating the pressure of gas, and certain other fluids or liquids. And, Secondly,—the improved combination of parts as shewn and described in reference to fig. 3, for regulating the pressure of steam and certain other fluids or liquids.

---

*To RICHARD GREEN, of the firm of Davis, Greathead, and Green, of the Flint Glass Works, Brettell-lane, in the county of Stafford, for improvements in insulators for insulating the wires or rods employed for conducting or transmitting electricity.—[Sealed 28th December, 1853.]*

THIS invention consists in a new mode of constructing insulators of glass or porcelain. The principal feature of novelty is the forming of such insulators entirely of glass or porcelain, and with a screw of the same material, for connecting the insulator to a post, to brickwork, or to any place to which the insulator is to be fixed, for supporting and maintaining the electric wires or rods in proper position. The patentee remarks, that he is aware of glass insulators having already been made, and used on railways, in which the cap and stem of the insulator are of one and the same piece of glass; but the screw of such insulators has invariably been made of iron or other metal; the objection to which is, that the expansion of the metal has been found to break the glass which surrounds it, thereby rendering insulators thus constructed entirely useless. The object of this invention is to obviate the above objection by constructing the screw, the cap, and the stem of the insulator of one homogeneous mass of glass or porcelain, instead of forming the insulator in separate pieces, as heretofore practised.

In carrying out his invention, the patentee takes a mould, of the desired shape of the insulator, complete, that is, with the stem, the cap, and the screw (for fixing it) shaped in one piece, and into this mould he pours the molten glass in the manner usually practised by glass-makers in casting glass.

The patentee claims forming the several parts of insulators (namely, the cap, the stem, and the screw) of one entire piece of glass or porcelain, instead of forming the same in separate

parts or pieces, composed of iron or other metal combined with glass or porcelain, as heretofore practised. And he claims, more particularly, the forming of the screw of the insulator of the same material as the other part thereof, as hereinbefore particularly described and set forth.

---

*To ALEXANDER ISAAC AUSTEN, of Trinity Place, Wandsworth Road, in the county of Surrey, engineer, for improvements in the apparatus used in the manufacture of mould candles.*—[Scaled 22nd July, 1853.]

THIS invention consists of improvements in the moulds used for the manufacture of candles. Heretofore such moulds have for the most part been made of metal; in some cases, however, glass has been employed, but such moulds are liable to injury by being fractured. Now this invention consists in combining glass with metal in such manner that the glass shall form the interior or lining of a mould, and for this purpose the melted metal is run on to the glass when it is in a suitable mould.

Previously to describing the manner of carrying out his invention, the patentee remarks, that it is not new to use candle moulds made of glass, nor is it new generally to coat the same. But this invention, as before stated, consists of casting a metal coating on to glass candle moulds.

For this purpose, the glass mould having been made, he proceeds as follows:—

The open ends of a glass tube, suitably shaped for a candle mould, is plugged up with a cork or piece of wood, through the centre of which, and through the small hole at the tip, is passed a wire, which projects at the two ends, and serves to keep the glass candle mould exactly in the centre of a mould of brass, or other suitable metal or material, and also to preserve, through the metal casting, the small hole required at the tip for the insertion of the candle wick. This brass mould is formed in two halves, which are held together by screws after the glass tube has been adjusted within it. At the end corresponding to the open end of the glass tube, a screwed thread may be cut in the inside of the brass mould, so that the metal casting, when withdrawn, may have a screw ready formed to fix the compound mould in its frame. The brass mould, which should be smoked on its interior surfaces, with its contained glass tube, is to be heated carefully, so as to lessen the risk of fracture consequent on the sudden contact of hot metal with glass in the cold state; and the melted metal to form the casing is then poured in through a hole,

with the usual precautions to prevent the entrance of dross, to ensure freedom from air bubbles, and to guard against faults from shrinkage. The metal for this casing may be lead, tin, pewter, or other easily fusible metal, or compound of metals; a mixture of lead and tin is, however, preferred for the purpose, in the portion of three parts of lead to two parts of tin. The compound candle moulds, thus formed, after removal of the wire and cork, and trimming up the surface, may be fixed in the well-known frames, by means of the screw around the open end of the casing, or otherwise, and such moulds may be wicked and used in the ordinary manner for making therein mould candles.

The patentee claims the forming of metal casings on glass candle moulds by casting metal thereon.

---

*To JOHN BARNES, of Church, in the county of Lancaster, manufacturing chemist, for a certain improvement or improvements in dyeing and cleansing cotton, silk, wool, and other fabrics.—[Sealed 28th December, 1853.]*

ACCORDING to this invention of improvements in dyeing and cleansing cotton, wool, and other fabrics, the patentee takes muriatic acid, or any of the acids which has a stronger affinity for lime than phosphoric acid (preferring muriatic acid for its cheapness), and to this he adds as much bone as it will take, always keeping the bone a little in excess. The acid will be neutralized, according to circumstances, in from two to four days, but it cannot be too long upon the bones; and, when neutralized, there will be a quantity of fatty matter upon its surface, similar in appearance to yeast or barm, which he skims off and treats as hereinafter stated.

To the neutralized acid as much carbonate of soda and potash, or ammonia, is added, as will simply neutralize or only slightly tint litmus paper to the alkaline side. The mixture is now ready for use as "dung substitute." The patentee remarks that he does not confine himself to any particular quantity of the afore-named articles, neither does he confine himself to bone, as other phosphates will answer, such as ivory-black, sugar-refiners' waste, &c.; but he prefers the mode specified, as if phosphate of lime alone is used, gelatine is required to be added.

The fatty matter, which is formed in the first operation, is simply boiled in water, when the tallow rises to the surface, which may be taken off; then the undissolved bones may be used over again, with the addition of fresh bone.

To GEORGE FERGUSON WILSON, of Belmont, Vauxhall, for improvements in the manufacture of candles and night lights.—[Sealed 10th October, 1853.]

THIS invention consists in preparing a material for the making of candles and night lights by combining unbleached stearine of palm oil with cocoa-nut oil, or its stearine, and with fatty acids, for the manufacture of candles and night lights.

In carrying out his invention, the patentee takes one part by weight of unbleached stearine of palm oil, one part by weight of cocoa-nut oil or its stearine, and one part by preference of distilled acidified palm oil (but other fatty acids may be used); and these matters he boils together in water, slightly acidulated by sulphuric acid, for about half-an-hour, by the aid of free steam. The combined matters are then allowed to settle and cool: they are then in a state to be used in the manufacture of candles and night lights, in the ordinary manner, when using other similar matters.

The patentee claims, the employment, in the manufacture of candles and night lights, of a combination of unbleached stearine of palm oil with cocoa-nut oil, or its stearine, and fatty acids.

---

To EDWARD JOSEPH HUGHES, of Manchester, for an improved method of purifying and concentrating the coloring matter of madder, munjeet, spent madder, or any preparations thereof, however they may be made.—[Sealed 29th November, 1853.]

THIS invention consists of defining more clearly and explicitly the mode or method of purifying and concentrating the coloring matter of madder, &c., as specified in a patent granted to the present patentee, 8th October, 1852\*, and of extending the principle of the said process to any preparation of the same or similar materials, however they may be made. In the said specification, the use of acid and water is claimed as a mixture; but it is found, from experience, that sulphuric acid alone will effect the purpose required, and that the process or operation may be extended to any preparations from madder, spent madder, or munjeet, however such preparations may be compounded. Therefore, the process or operation of subjecting madder, spent madder, or munjeet, or any preparations thereof, or any materials containing any portion of the same, to the action of sulphuric acid, is now claimed, either in its

\* See Vol. XLIII., p. 178, Lond. Jour.

purely concentrated state, or slightly diluted with water; being particularly careful to keep the mixture cool, or, in other words, to avoid fermentation as much as possible.\* The degree and power of action of the acid on the fibrous or other substances will depend on the strength of the acid used, and the time occupied before adding the water to it. This process or principle is applicable to extracting the coloring matter from printed goods, as well as from dye stuffs.

The patentee claims the use of sulphuric acid, either concentrated or diluted, for the purpose of extracting the coloring matter from various substances, as herein described.

---

*To WILLIAM FAWCETT and FRANCIS BEST FAWCETT, of Kidderminster, in the county of Worcester, carpet manufacturers, for certain improvements in the manufacture of carpets.*—[Sealed 18th April, 1853.]

THIS invention, which has reference to certain improvements in the ordinary cut and looped fabrics, known by the names of Florentine and imperial carpets, has for its object the dispensing with half the number of worsted or woollen threads used in forming the back of such carpets in the ordinary processes; whereby the manufacturer may be enabled to produce patterns more elaborate and beautiful, and comprising a greater variety of colors, or shades of colors, at a little above half the present cost of the manufacture of such carpets. These improvements are effected by producing two shades of color with the same threads of worsted or woollen, by employing the threads in a looped pile for a light shade, and in a cut pile for the dark shade; the simple cutting of the pile producing a sufficient difference of shade to be appreciable in the pattern.

The patentees remark, that the old imperial carpet combined the looped and cut pile in one fabric, but so that the loop was confined to the ground, and the cut to the figure, or other part of the pattern, or *vice versa*, the same thread not being both looped and cut in the same fabric, as by this invention. The old Florentine carpet also combined the looped and cut pile in the same fabric, but so that the threads forming them came on each and every alternate wire; that is, the threads on one wire were all looped, and those on the

\* The patentee has appended a memorandum of alteration to his specification, in which he disclaims the words, "or, in other words, to avoid fermentation as much as possible," and inserts instead thereof, "in all stages of the process;" by which alteration the passage is made to read thus:—"being particularly careful to keep the mixture cool in all stages of the process."

succeeding wire all cut, and not used to shade the different parts of the pattern, or to effect a saving of the worsted, as by this invention.

In carrying out this invention, an ordinary Brussels carpet loom is employed, and the ordinary lash is divided into two parts: the one part for the cut or dark shade; the other part for the terry or light shade. That intended for the dark shade is drawn up in the ordinary manner, and the cut or grooved wire inserted, and the other part is afterwards drawn up, and the terry or flat wire put in; and both wires are then bound as one wire with three shutes, as the ordinary three-shute tie. The lash is divided by either stamping a card for each shade (that is, two cards instead of one card, as now used, if worked in a Jacquard loom), or putting in two lashes, instead of one, in a draught loom. The number of cut or grooved wires may be limited to three; the one next the weaver having to be cut out by rotation. The number of terry wires may be extended, as at present, to from forty to sixty; but they should be flat, with large bows, similar to those used in tapestry carpeting. Both terry and cut wires may be of the same size, and about No. 15 in thickness, and Nos. 12 or 13 in height. The improved fabric can be woven in all the ordinary Brussels looms, but, as the cut part should not be pressed, a spike roller is required to be substituted for the ordinary roller.

The patentees claim using the same thread of worsted or woollen to produce a dark and a light shade in the pattern, by suitably cutting or looping the pile in the manner and for the purposes hereinbefore described and set forth.

### Scientific Notices.

#### INSTITUTION OF MECHANICAL ENGINEERS BIRMINGHAM.

AT the Annual General Meeting, held at the house of the Institution, Newhall-street, Birmingham, January 25th, 1854,—the following paper, by Mr. CHARLES WILLIAM SIEMENS, of London, was read:—

##### *On an improved water-meter.*

The rapid growth of water-works, in this and other civilized countries, extending to towns of second and third rate importance, has rendered the production of an efficient water-meter a matter of considerable practical interest.

A good water-meter, besides its application to the purpose of water-works, will be found a useful auxiliary to brewers, distillers, and liquid merchants generally; also to engineers and to all engine proprietors; by furnishing a register of the water pumped into steam-boilers; from which a correct estimate may be found of the evaporative powers of the boiler, and the relative quantity of the fuel employed, independently of the working conditions of the engine.

The meter is required to fulfil the following conditions:—

1. It must register correctly the quantity of water passed through the meter, either at high or low speeds.
2. It must not be affected by the pressure of a high column of water upon its working parts.
3. It must allow the water to pass through without obstructing or at intervals checking the same.
4. Its working parts must be protected against the effects of mechanical impurities or corrosive agencies in the water, so as to insure its continuous working without frequent attention.
5. It must be a cheap and compact instrument, adapting itself conveniently and locally to ordinary circumstances.
6. Its working and registering parts must be inaccessible to the employer, in order to prevent fraud.

The fulfilment of these conditions might at first sight appear an easy problem for a skilled mechanic, but the numerous and fruitless attempts that have been made at its solution have proved the real difficulty of the task. In order to combat these difficulties successfully, it is necessary to discriminate between those that are inseparably connected with certain principles of action, and those of mere detail of arrangement, or choice of material. All meters that have hitherto been proposed may be classed under the four following heads, viz:—1. Cistern or bucket-meters. 2. Piston-meters. 3. Meters by area of channel. 4. Meters by impact.

Mr. Mead, of London, proposed a registering bucket-meter, of very simple construction, consisting of a mould or double bucket, divided equally by a cross partition and carried by a rocking shaft. Perpendicularly above this rocking shaft is the open mouth of the supply-pipe, for filling alternately the one and the other bucket. At the extremities of the buckets, small pockets are provided, that fill at the instant their respective buckets overflow, and being at the greatest distance from the rocking shaft, cause the filled bucket to overbalance the empty one, and discharge itself into the cistern below. The supply of water is regulated by means of a float and a cock. The rocking shaft gives motion to a counting apparatus by means of a ratchet and wheel.

Mr. Parkinson, of London, invented a bucket-meter, pertaining in its construction to the ordinary gas-meter, which is found to register the water passing through with great accuracy, and is actually used to a great extent in connection with receiving cisterns.

The disadvantage of these meters is that they destroy the on-

ward pressure of the water, and are of necessity incumbered by cisterns at elevations above the premises supplied.

The name "piston-meter" is intended to comprise all meters in which the fluid is measured by displacing a piston, a disc, or a diaphragm, and thereby filling a measured cavity.

The piston-meter in this respect resembles the bucket-meter, with the advantage of transmitting the onward pressure of the water, and of dispensing with the necessity of a cistern. On the other hand it labours under great and peculiar disadvantages, partly on account of the valves and pistons which are employed being quickly destroyed by the sand and other impurities contained in the water, or broken by its impact against them, and partly on account of their great bulk and expense in proportion to the water measured.

It will only be necessary to mention a few of the multitude of piston-meters that have been proposed, for the sake of illustration. Those of Lewis, and Taylor, both of Manchester, and of Messrs. Barr and Macnal, of Paisley, are examples of single cylinder-meters, with tumbler arrangements to reverse the valves suddenly, in order not to check sensibly the column of water moving through the pipes. Captain Ericsson, of America, and Mr. Chrimes, of Rotherham, simultaneously proposed a meter, consisting of two cylinders working on cranks at right angles to one another, in order to equalize the flow through the pipes, and to be able to apply slide valves, worked by excentrics, in place of the more complicated tumbler arrangements. Mr. Roberts, of Manchester, constructed, in 1851, a cylinder-meter, made to tumble or oscillate by the weight of the piston. Messrs. Bryan, Donkin, and Co., of London, invented, in 1850, a disc-meter; Mr. Parkenson, of Bury, and Messrs. Chadwick and Hanson, of Salford, have substituted India-rubber diaphragms for the piston, and the disc, respectively. Mr. Adamson, of Leeds, made a meter resembling the rotary engine, in which direction he has been followed by several others.

The last-named meter is the only one of this class that has been practically used for several years (at Leeds), but it was finally superseded, on account of excessive wear and tear, and frequent stoppages.

A meter "by area of flow" pre-supposes a constancy of pressure, and knowledge of the time of continuation of flow. It is practically resorted to for measuring, approximately, large volumes of water, by passing it over an overflow, and taking into account the depth of water column, its breadth, and the time of flowing.

The great inconvenience of this system is illustrated by the fact that many houses in Paris require upwards of ten cisterns for the supply of the different inmates. Besides which it is unjust, for it obliges every consumer to pay at a maximum rate.

Several years since (in 1845), the writer of the present paper invented a meter which measured by area of channel, and dispensed with the necessity of a cistern; registering the quantity of



water actually passed through. It consisted of a square pipe, containing a common flat valve, which the water had to raise in order to pass through. The spindle of this valve passed through a stuffing box, and carried a lever which by its motion raised or lowered a driving strap upon two reversed cones. The cone, with its apex pointing downwards, received a regular motion by means of clockwork, while the reverse cone communicated motion received through a strap to a counting apparatus. When no water passed through, the flat valve was closed, and the clockwork stopped by means of a detent. The instant however the valve was raised by the passage of water, the clockwork was released, and a very slow motion was imparted to the counting apparatus; and in proportion as the flow increased, the strap was raised and the motion of the counting apparatus increased.

A meter differing only in its details from the above, has recently been brought out by Mr. Kennedy, of Kilmarnock.

The frequent necessity for winding up the clock movement rendered this meter unfit for general application. To obviate this, the writer thought of abstracting the motive power for the clock from the water itself, by introducing a screw propeller into the pipe.

Being advanced thus far, it became apparent that the valve and clockwork might be entirely dispensed with, if the propeller could be made to rotate in the precise ratio of the moving column of water, and to impart that motion directly to the counter.

Thus the first step was made toward the production of a meter by impact, by which it is contended the conditions above enumerated of a perfect meter are most fully realized.

The writer considers it an essential condition of an impact meter, that the propelled vanes merely glide edgewise through the water, by partaking fully of its onward motion, without sensibly impeding or agitating the same.

These conditions are most fully complied with by a perfect screw suspended on two pivots, in the axis of the moving column of water. They are also fulfilled by a Barker's mill, or turbine of spiral blades, that yield to the motion of the water outward from a centre.

The correctness of the author's supposition was proved indirectly by the failure of an attempt made at about the period referred to, by Mr. Abraham, to register the water flowing through a pipe by means of a screw propeller of irregular form, although suspended with great care between points of agate.

The same unsatisfactory result was obtained some years later by Mr. Tebay, of London, who formed his propeller by making radial incisions into a disc of brass plate, mounted upon a spindle, and by twisting each segment in the same manner, like the vanes of a windmill. He endeavoured to counteract the inaccuracy of his propeller by introducing valves so contrived that the water should be able to pass only at a fixed velocity.

In order to obtain correct measurement by an impact meter, it is not sufficient that the propeller should yield equally in all its

parts to the motion of the water, but it must also possess the power to overcome a uniform resistance by friction in its bearings, &c., without diminishing its proportionate rate of rotation at low speeds.

The apprehension of these difficulties deterred the writer, for several years, from proceeding, until the pressing want for a meter, to carry out some other improvements, induced him to construct, in 1850, the meter exhibited to the meeting; which meter, in point of accuracy of measurement and compactness, fully satisfied a committee of inquiry of the Manchester Corporation Water Works, by whom its adoption was recommended. The successful results obtained by this meter, which the writer had not even an opportunity to adjust previous to its official trial, were thought strong proofs in favor of the principle involved. He was indebted for the first execution of his idea, and some valuable suggestions, to his brothers at Berlin.

In attempting, however, to put the meter into regular service, under a working pressure of upwards of 200 feet column of water, subject to violent concussions, and acted upon by mechanical as well as chemical impurities in the water, he, and the manufacturers, Messrs. Guest and Chrimes, of Rotherham, had to encounter many serious difficulties, which finally determined them to adopt, for smaller meters, the more simple arrangement of a spiral curve, or Barker's mill.

One arrangement now adopted consists of an apparatus having a double screw or balance-meter capable of measuring 100,000 gallons per hour, or above two million gallons per day.

This meter is provided with a cylindrical casing, lined throughout with a brass tube, drawn to a precise gauge, and connected by its flanges to a line of piping of 8 or 9 inches in diameter.

The measuring apparatus contained in this casing consists of two hollow drums, which carry, on their circumference, the one a set of right-handed and the other a set of left-handed screw-blades. Conical blocks, armed with radial projections or guide-blades, are fixed at each end of the apparatus, extending nearly to the two screw drums, which are caused to rotate by means of bevil wheels. Two double inverted cones are provided, one at each end of the casing, for the purpose of directing the water towards the centre thereof.

The main spindle, carrying the upper bevil wheel, passes, through the hollow arm of a central bracket, into a close chamber, and carries an endless screw, which drives the counting apparatus.

The water enters the meter through a grating, which is provided to arrest large solid bodies that might obstruct the working of the apparatus. The inverted cone at the inlet end of the meter, directs the current of water toward the centre, where it again spreads over the conical block, and, being directed parallel to the axis between the guide vanes, impinges obliquely upon the right-handed vanes of the hollow screw drum. The object of

(figuratively speaking) kneading the current of water between the conical surfaces is, to destroy partial currents within the same; and in spreading it from the axis, to increase its leverage on the rotating drum. The diameter of the body of the drum is made slightly smaller than the diameter of the conical block, in order to protect the former from endway pressure of the moving column of water. Some clearance is allowed between the helical vanes and the surrounding casing; but the passage of water outside the vanes is effectually prevented by slight contractions of the waterway at both ends. In order to prevent wear and friction on the bearings, the body of the revolving drum is made hollow to such an extent that the water displaced nearly balances the weight of metal. A screw drum of this description moves with a very gentle current of water, but it would, nevertheless, make a very imperfect meter if it were simply connected to the counter, inasmuch as the friction in the bearings and of the counter would retard it most at low speeds, and the friction of the vanes in gliding through the water (which increases in the ratio of the square of the velocity) would again greatly retard it at high speeds,—the maximum rate of measurement being obtained at a medium speed.

By the addition of the second or left-handed drum, these variations in speed are compensated. For the sake of illustration, let it be imagined, that both screw drums revolve independently of each other (of course in opposite directions), and that the second or left-handed one alone imparts its motion to the dial; let it also be supposed that the friction of both drums is the same;—the water, in meeting the oblique vanes of the first drum in a direction parallel to the axis, will be deflected from its straight course proportionally to the resistance to rotation of the drum, say an angle of  $1^\circ$ . Pursuing its fresh course, it will strike the left-handed screw blades of the registering drum, in an angle at  $1^\circ$  more obtuse than the previous; and, being deflected by the resistance offered through  $1^\circ$  in the opposite direction, the water will pass out in a direction parallel to the axis, and, consequently, a true rate of measurement will be obtained. By coupling both drums rigidly together by bevil gearing, a great practical advantage is obtained, namely, that of one drum assisting powerfully to overcome an obstruction offered to the other. Let it be imagined, for instance, that a pebble or piece of vegetable matter has wedged itself between the casing and tip of the vane of the first drum, so as to stop it entirely, and to force the column of water passing through into the helical course: the water would then impinge upon the left-handed vanes of the second drum rectangularly (supposing the inclination of the reverse vanes to be at an angle of  $45^\circ$  to the axis), and expend its entire momentum upon it; the effect of which would be added to the impact on the first drum through the bevil gearing, to overcome the obstruction. The motion is conveyed to the counter by the upper bevil wheel; but the lower wheel is added to strengthen the connection between the two drums, and to relieve all the spindles from pressure. Before

leaving the meter, the current of water is again contracted between conical surfaces, for the same purpose as before, namely, to equalize its flow.

In calculating the quantity of water that will effect one complete revolution of the screw-drums, it is necessary to compute the clear net area between them and the external casing,—supposing all the surfaces to be covered with a film of stationary water (by adhesion),  $\frac{1}{10}$ th part of an inch in thickness, and to multiply the same by the pitch of the screw. The correction for adhesion amounts to an inappreciable quantity for large meters, but constitutes a considerable per-centage in the calculation for small meters.

The difficulties that have been encountered in the manufacture of this meter apply principally to the spindles. Although relieved from all constant pressure, they have nevertheless to maintain the drums in their central position, and to resist a strain endways, caused by the mere friction of the water in passing along the vanes;—they have in consequence to be made of hard metal. A hard bronze was found to be the most suitable metal, and answers well for meters of large size; but it is difficult to produce the spindles for small meters of that metal.

The difficulty at first experienced of producing screw-drums of correct shape and uniform size, without incurring a large amount of workmanship, was successfully removed by casting them, and many other parts, in metallic moulds. The manufacturers also tried gutta-percha, which, being slightly lighter than water, was, with its spindle, exactly equal to the weight of water which it displaced; but it could not be made sufficiently correct and rigid in the vanes. After some time the manufacturers succeeded in casting drums for the larger meters of bronze, and in dry sand, with great accuracy.

The calcareous matter in water deposits only on the surfaces of brass that are not exposed to the current. It exercises therefore no effect on the measuring surface, but if allowed to penetrate into the chamber of the counting apparatus, it incrusts the small wheels and spindles, and causes them to break or wear rapidly. To alleviate this, a lower division of the box containing the counting apparatus, is filled, before it leaves the manufactory, with pure olive oil, which affords a complete and continuous protection to the wheels.

For meters having a supply pipe of less than two inches diameter, the spiral form of propeller, or Barker's mill arrangement, is adapted; except in cases where the water acts impulsively, as, for instance, in supplying steam-boilers by means of pumps;—where the double screw meter is the only one applicable.

In the second arrangement of the meter before alluded to, the water enters through a side pipe, and traversing a cylindrical grating, covered with wire gauze, it passes downward through a central funnel, into the propeller; and issuing from two apertures of its circumference, it passes into a chamber leading to the exit pipe.

At the bottom of the propeller a chamber is formed, filled with oil through small apertures at the bottom, and sealed close, leaving only an eye in the centre, through which an upright stud of bronze enters, which, with its steel point, abuts against a steel plate in the bottom of the propeller. The lower chamber of the counting apparatus box is formed of white metal, cast in one piece with the wire gauze grating, and it is filled completely with oil.

Theoretically speaking, this meter is less perfect than the compensating screw-meter, but it possesses the great advantage of containing only a single bearing that is at all liable to wear, and that bearing is effectually protected from the action of the water. The practical effects of this simplification of parts has been, that, of 150 meters of this description that are at work, not one has as yet been returned disabled or inaccurate.

Mr. Adamson, of Leeds, has lately projected a meter with two sets of spiral blades, upon the principle of a turbine; the inner set being stationary, and the outer set revolving. This meter also gives a very good result.

Another kind of meter lately brought out by Mr. Taylor, of Manchester, having a revolving horizontal drum or water-wheel, acts partly by jet and partly by impact; but on this account it appears to the writer imperfect in principle.

It has been argued before that no accurate measurement can be effected by the application of jets. To avoid them in the spiral meter, it is essential to make the area of the outlet larger than the area of the supply-pipe. Nevertheless the nature of a jet still manifests itself to some extent by increasing the rate of the meter at high velocities. This defect has however been effectually counteracted by the application of rotating flies or drag-boards fixed to the outer edge of the propeller, which offer a resistance increasing as the square of the velocity, and can be regulated to equal the effect obtained by the jet. They offer also great facility in adjusting the absolute measurement of the meter.

In order to insure the efficiency of each meter, it is necessary to test the same under variable pressures, and with considerable volumes of water. To this point the manufacturers, Messrs. Guest and Chrimes, have devoted great attention. The apparatus they employ consists of a large cistern, 40 feet high, and a second cistern below, capable of containing 1000 gallons, and accurately graduated throughout. A set of pipes which have been proved to transmit given quantities of water per minute, under the pressure from the upper cistern, is provided, and from 8 to 12 meters to be tested are coupled in a line, one behind another, to a pipe leading from the upper cistern to the outlet of the meters. The test pipes are then alternately connected; a uniform quantity of water, as shewn in the cistern, is passed through each pipe, and the number of gallons indicated on the different counters is noted in a book, opposite to the permanent number of the respective meters. An extract from this book shews how nearly correct a measurement is obtained.

PROVISIONAL PROTECTIONS GRANTED.

[*Cases in which a full Specification has been deposited.*]

1606. Nicholas Callan, of Maynooth College, for a means by which iron of every kind may be protected against the action of the weather and of various corroding substances; so that iron, thus protected, will answer for roofing, for cisterns, baths, gutters, window-frames, telegraphic wires, for marine and various other purposes; and by which brass and copper may be similarly protected.
1607. Auguste Edouard Loradou Bellford, of Castle-street, for certain improvements in breech-loading fire-arms,—being a communication.

*The above bear date July 21st.*

1653. William Beare Caulfield, of Cole Harbour, Blackwall, for the manufacture of brushes to be used in cleaning the small tubes of steam-boilers, and for other purposes.—[*Dated July 27th.*]
1671. Peter George Harris, of Buckingham-street, Adelphi, for improvements in locomotive engines,—being a communication.
1673. Edmund Burke, of Upper Thames-street, for certain improvements in instruments for withdrawing corks and in uncorking bottles.

*The above bear date July 29th.*

1756. Thomas Lawrence, of Birmingham, for an improvement or improvements in the manufacture of bayonet blades, and in machinery or apparatus to be employed for that purpose.—[*Dated August 11th.*]

[*Cases in which a Provisional Specification has been deposited.*]

1046. Joseph Shepherd, of Manchester, for improvements in compound steam-engines.—[*Dated May 10th.*]
1133. Berkeley William Fase, of Charles-street, Soho-square, for an improved construction of brooch for fastening dresses.—[*Dated May 22nd.*]
1177. James Lord, of Farnworth, for improvements in the manufacture of articles of ladies' under clothing.—[*Dated May 26th.*]
1189. William Northen, of Vauxhall-walk, for improvements in the manufacture of mangers and troughs for stables.—[*Dated May 29th.*]
1193. Richard Tomlinson, of Sale, Cheshire, for the application of a new material or fabric to the manufacture of plasters for medical or surgical purposes.—[*Dated May 30th.*]
1236. John Renton, of Bond-street, Vauxhall, and Henry Attwood, of Holland-street, Blackfriars, for an improvement in the

manufacture of starch, applicable in part to the solidifying of colors and other substances held in solution or suspension.—  
[*Dated June 3rd.*]

1250. Lemuel Brockelbank, of Willesden, Middlesex, for improvements in manufacturing lubricating matters.—[*Dated June 5th.*]

1281. John Braithwaite, of Gower-street, for an improved method of roofing or covering buildings, reservoirs, and other spaces requiring roofs or coverings.—[*Dated June 10th.*]

1328. Thomas Mara Fell, of King William-street, and William Cooke, of Curzon-street, for improvements in bottles and bottle stoppers, and in stopping and applying the same.—[*Dated June 19th.*]

1438. John Mc Gaffin, of Liverpool, for improvements in the manufacture of iron casks and cisterns.—[*Dated June 30th.*]

1443. Thomas Richards Harding, of Leeds, for improvements in the manufacture of the pins of hackles, combs, and cylinders used in hackling, combing, and preparing wool, flax, and other fibrous substances, and in the mode of applying them to manufacturing purposes.—[*Dated July 1st.*]

1478. John Venables and Arthur Mann, both of Burslem, for printing self and other colors in bas-relief or raised work on china, earthenware, glass, parian, stone-ware, bricks, blocks, tiles, quarries, hardware, japan, and papier-mâché ware.—  
[*Dated July 5th.*]

1479. Samuel Harvard and Joshua Womersley, both of Stoke Holy Cross, Norfolk, for heating crushed seed for making cake, for drying seeds, corn, and other grain, and for feeding mill-stones or other grinding apparatus.

1481. John Arrowsmith, of Bilston, for a new or improved method of consuming or suppressing smoke and obtaining motive power therefrom.

1483. Peter Armand Le Comte de Fontainemoreau, of South-street, for certain improvements in apparatus for breaking in horses,—being a communication.

1487. John Henry Johnson, of Lincoln's-inn-fields, for improvements in machinery or apparatus for effecting agricultural operations; parts of the said improvements being applicable for the obtainment of motive power for general purposes,—being a communication.

1489. James Edward Mc Connell, of Wolverton, for improvements in wheels, axle-boxes, and brakes for railway carriages.

1491. William Pole, of Storey's-gate, Westminster, for certain improvements in the construction of railways.

*The above bear date July 6th.*

1493. William Lacey, of Aston-juxta-Birmingham, for a new or improved method of making copper rollers, cylinders, and tubes.

1494. Andrew Morison, of Inchmichael, Perthshire, for an improved mode of protecting or preserving agricultural and horticultural produce from disease or blight.

1495. George Beard and William Beard, both of Cannon-street, for an improved needle depositor.
1496. Jesse Ross, of Keighley, for improvements in making compounds of chocolate, cocoa, and other ingredients, for breakfast and occasional beverages.
1497. Alfred Vincent Newton, of the Office for Patents, 66, Chancery-lane, for an improved construction of pump for raising and forcing fluids,—being a communication.
1498. James Lee Norton, of Holland-street, Blackfriars, for improvements in turnstile counting apparatus.
1499. Joseph Ellison, of Liverpool, for improvements applicable to reading, lounging, and other chairs.
1500. Henry Richard Cottam, of Argyle-square, King's Cross, for improvements in horse mangers.

*The above bear date July 7th.*

1501. Thomas Waller, of Ratcliff, for improvements in the construction of stoves and other fire-places.
1502. William Robinson and Robert Crighton, both of Manchester, for improvements in machinery or apparatus for rolling metals into suitable shapes or forms.
1503. Lorenzo Tindall, of Scarborough, for improvements in bruising or reducing grain and other substances.
1505. The Honorable James Sinclair, commonly called Lord Berriedale, of Hill-street, Middlesex, for improvements in the manufacture of paper and in the production of textile materials.
1506. Felix Lieven Bauwens, of Pimlico, for improvements in the manufacture of soap.
1507. Thomas Schofield Whitworth, of Salford, for improvements in machinery or apparatus for cutting or shaping wood; parts of which are particularly applicable in the construction of spinning machinery.
1508. Edward Lord, of Todmorden, for improvements in machinery for cleaning and carding cotton and other fibrous materials.

*The above bear date July 8th.*

1509. David Beck, of Carlton House, Southampton, for improvements in brewing and distilling.
1510. Stephen Martin Saxby, of South Lambeth, for an improvement or improvements in making fast, and letting go, the cords of window-blinds; which said improvement or improvements may also be applied to the fastening and letting go of ropes, cords, lines, wires, and chains, for various other purposes.
1511. Israel Swindells, of Manchester, for improvements in the treatment of wood and vegetable matters, for the production of vegetable fibre.
1512. George Arthur Biddell, of Ipswich, for improvements in machines for cutting vegetable and other substances.

*The above bear date July 10th.*



1514. Edwin Wolverson, of Aston-juxta-Birmingham, for a new or improved lock.
1516. Matthias Walker, of Horsham, for an improved construction of cooking-stove.
1517. Thomas Richards Harding, of Leeds, for an improved mode of doffing fibrous materials from hackle cylinders and gill or porcupine or preparing rollers.
1518. Charles Frederick Moore, of Portswood-park, Southampton, for improvements in the construction and use of an apparatus, closet, or receptacle, to be used instead of a water-closet or other necessary, and which may be either fixed or portable.
1519. Victor Gustave Abel Cuvier, of Seloncourt, France, for an improved apparatus having for object the combustion of fuel and the utilization of the gaseous products for heating, and other useful metallurgic purposes.

*The above bear date July 11th.*

1521. William Houghton and Robert Hoyle, both of Bury, for improvements in machinery for spinning and doubling cotton and other fibrous substances.
1522. Frederick Albert Gatty, of Accrington, for an improvement in the manufacture of printed receipt stamps.
1523. Matthew Townsend, of Leicester, for improvements in the manufacture of knitted fabrics.
1524. Oliver Maggs, of Bourton, Dorsetshire, for improvements in thrashing-machines.
1525. Luke Cooke, of Sowerby Bridge, Yorkshire, for improvements in machinery or apparatus for preparing cotton, wool, or other fibrous substances to be spun.
1526. John Knowelden, of Church-road, Battersea, for improvements in steam-boiler and other furnaces.
1527. Thomas Edwin Moore, of Saint Marylebone, for improvements in apparatus to be used for extinguishing fires.
1528. Robert Armstrong, of Hall-street, City-road, and James Bernard Dew, of Pentonville, for an improved apparatus for consuming smoke.
1529. Alphonse Julien Loiseau, of Paris, for certain improvements in manufacturing fringes and other platted fabrics.
1530. Josiah Thompson Marshall, of New York, for improvements in reefing and furling the sails of ships or other vessels.
1532. James Robertson, of Kentish-town, for improvements in the consumption or prevention of smoke.
1533. Charles Durand Gardissal, of Paris, for a stamp-safe.
1534. Auguste Edouard Loradoux Belford, of Castle-street, for improvements in preserving animal substances,—being a communication.

*The above bear date July 12th.*

1535. William Flitcroft, of Bolton, and Thomas Evans, of Manchester, for improvements in printing and finishing floor-cloths

- or any other fabrics or materials printed in oil-colors,—being a communication.
- 1536. Arthur James Lane, of Surbiton, for improvements in breech-loading fire-arms.
- 1537. Thomas Bennett Foulkes, of Chester, for improvements in the manufacture of self-adjusting gloves.
- 1538. John Greenwood, of Irwell Springs, near Bacup, and Robert Smith, of Bacup aforesaid, for certain improvements in sizing, stiffening, and finishing textile materials or fabrics.
- 1539. Lionel Lawson, of Paris, for improvements in printing.
- 1540. Edwin Travis, of Oldham, for certain improvements in machinery or apparatus for indicating and registering the height of water, and also the pressure of steam in steam-boilers or generators.
- 1541. John Hackett, of Derby, for a new method of fastening the ends of India-rubber, elastic cord, and India-rubber elastic web.
- 1542. Rudolph Bodmer, of Thavies Inn, for the application of glass, crystal, or other vitreous material, or of earthenware (céramique), to certain parts of machinery,—being a communication.
- 1543. John Baptist Chauvet, fils, of Aix, France, for a new system of anchor.

*The above bear date July 13th.*

- 1545. Alexander Southwood Stocker, of the Poultry, London, for improvements in axles.
- 1546. William Bishop, of Boston, Lincolnshire, for improvements in machinery or apparatus for ticketing or labelling spools, parcels of the same, or other similar parcels.
- 1547. Charles Sewell, of Longton Lodge, Sydenham, for an improvement in spring hinges for doors and gates.
- 1548. Martin Wiberg, of Lund, Sweden, for improvements in the construction, setting up, and distribution of types for printing.
- 1549. John Mc Gaffin, of Liverpool, for improvements in the mode of corrugating angular iron.
- 1550. John Mc Gaffin, of Liverpool, for improvements in the construction of iron bridges.
- 1551. James Derham, of Bradford, Yorkshire, for improved machinery for combing wool and other fibrous substances.
- 1552. Astley Paston Price, of Margate, for improvements in the distillation of wood and of other vegetable substances.
- 1553. Jean Baptiste Dechanet and Antoine Dominique Sisco, of Paris, for certain improvements in the construction of railway carriages.

*The above bear date July 14th.*

- 1554. Elijah Henry Brindley, of Longton, for certain improvements in printing or ornamenting china, earthenware, and glass.

1555. James Taylor, of Burnley, for an improved clothes-peg,—being a communication.
1556. Ralph Waller, of Manchester, for improvements in the manufacture of letters and figures, and of ornamental sign-boards and other tablets, and in affixing letters, figures, or ornaments to glass.
1557. François Victor Guyard, of Gravelines, France, for certain improvements in the electro-telegraphic communications for preventing mishances during the passage of trains on railways.
1558. Thomas Wright, of George-yard, Lombard-street, for improvements in the permanent way of railways.
1559. John Ashworth, of Turton, Lancashire, for certain improvements in apparatus to be employed in the construction of the permanent way of railways.
1560. Thomas Summerfield, of Birmingham, for the manufacture of chromatic glass and glass-faced bricks; which said bricks are applicable to face work or fronts of buildings, base-ments, pilasters, string courses, door and window heads, modillions, cornices in part or whole, or other purposes where a superior finish and durability are required; a part of which is also applicable to bricks made wholly of clay.
1561. William Hunt, of Tipton, Staffordshire, for improvements in utilizing certain compounds produced in the process of galvanizing iron, and in the application of the same and similar compounds to certain useful purposes.
1562. George Wade Kelsey, of Hope Farm, near Folkstone, for improvements in air-engines.
1563. Matthew French Wagstaffe, of Walcot-place West, Lambeth, and John William Perkins, of Poplar-terrace, Poplar, for improvements in obtaining metals from ores and oxides.
1564. Joseph Spires, of Cleveland-street, Fitzroy-square, for improvements applicable to boots and shoes.

*The above bear date July 15th.*

1565. John Bailey Denton, of Stevenage, for improved hoes and spuds.
1566. Thomas Mayos Woodyatt, of Kinver Mills, Staffordshire, for an improvement or improvements in consuming or suppressing the smoke of steam-engine boiler and other furnaces.
1567. George North, of Lewisham-road, for an improved apparatus to be attached to garments for protecting watches, purses, and other articles from being stolen from the person.
1568. William Warcup, of Bristol, for improvements in the construction of springs for carriages and similar purposes.
1569. John Lockhart, jun., of Paisley, for improvements in the manufacture of bobbins.
1570. John Fowler the younger, of Temple-gate, Bristol, for improvements in draining ploughs.

1571. John Livesey, of New Lenton, for improvements in lace machinery, and in fabrics manufactured by such machinery.

*The above bear date July 17th.*

1572. James Barlow, of Accrington, for improvements in the mode or method of extracting gluten from wheat or flour, and preparing the residuum for sizing purposes.

1573. Henry Hitchens, of King William-street, and William Batley, of Dean-street, for certain combinations of materials suitable for mouldings and medallions, and to be employed as a substitute for wood, gutta-percha, and other like materials.

1574. Mary Caroline Hill, of Dublin, for an improvement in bonnets and in bonnet-frames.

1576. Richard Hornsby, of Spittlegate Iron Works, Grantham, for an improvement in the straw-shaking apparatus of thrashing machines.

1577. Auguste Edouard Loradoux Belford, of Castle-street, for a new kind of piston,—being a communication.

1578. George Twigg and Arthur Lucas Silvester, of Birmingham, for improvements in apparatus or machinery for stamping or pressing metals.

1579. Peter Cato, of Liverpool, for an improved manger or trough for holding the provender of horses, cattle, and other animals.

1580. William Beckett Johnson, of Manchester, for improvements in steam-engines.

1581. Alexander Dalgety, of Florence-road, Deptford, for improvements in the reduction of friction.

1582. Peter Armand Le Comte de Fontainemoreau, of South-street, for improvements in zincography,—being a communication.

1583. Samuel Mitchell, of Dewsbury, for improvements in the manufacture of cards for carding wool, cotton, silk, and other fibrous materials.

*The above bear date July 18th.*

1584. John Collis Browne, of Cheltenham, for improvements in the manufacture of camp bedsteads.

1585. Jonas Whiteley, John Slater, and William Henry Crossley, all of Halifax, for improvements in machinery or apparatus for preparing and spinning wool and other fibrous substances.

1586. James Longley, of Hunslet-road, Leeds, for a machine for turning and finishing tubs, pails, casks, and other wooden vessels of an elliptic, oval, or other excentric form.

1587. William Ball, of Rothwell, Kettering, for improvements in drills.

1588. Matthew Michell, of Stoke Newington, for an improvement in furnaces, having for object the consumption of smoke.

1589. Francis Herbert Wenham, of Effra Vale, Brixton, for certain improvements in steam-engines.

*The above bear date July 19th.*

1590. John Sudbury, of Halsted, Essex, and Samuel Wright, of Clare, Sussex, for improvements in taps and valves, and in the method of working them, for the purpose of regulating the passage of fluids.
1591. Richard Roberts, of Manchester, for improvements in machinery for preparing to be spun cotton and other fibres.
1592. Jean Barthelemy Gillet, of Agde (Hérault), France, for improvements in capstans, winches, and windlasses.
1593. George Jackson, of Manchester, for certain improvements in the construction of tents.
1594. Joseph Barnes, of Church, Lancashire, for certain improvements in furnaces or fire-places.
1595. Francis Whitehead and William Whitehead, both of Crayford, for improvements in safety lamps.
1596. John Hackett, of Derby, for covering India-rubber thread, whether vulcanized or otherwise, with sewing silk, and with other articles.
1597. William Palliser, of Comragh, Waterford, for improvements in projectiles for fire-arms and ordnance generally.

*The above bear date July 20th.*

1598. Thomas Chambers, jun., of Colkirk, Fakenham, Norfolk, for improvements in machinery for distributing manure.
1600. Toussaint Delabarre and Leon Bonnet, both of Grenelle, near Paris, for the preservation of meat in its natural state, and without being cooked.
1601. Amand Benoit Joseph Jean and Alfred Alexandre Hugues, both of Paris, for certain improvements in reducing the friction of axles, bearings, or other rotatory rubbing surfaces, in machinery.
1602. Alfred Vincent Newton, of the Office for Patents, 66, Chancery-lane, for an improved construction of metallic spring,—being a communication.
1603. John Thomas Moss, of Arundel-street, Strand, for improvements applicable to apparatus for roasting meat and other edible substances.
1604. John Knight, of Birmingham, and James Stubbs, of Oldbury, Worcestershire, for an improvement or improvements in the manufacture of bricks, tiles, pipes, and such other articles as are or may be made of clay; which improvement or improvements may also be applied to the manufacture of artificial fuel, and to other mixing and tempering processes.
1605. Isaie Alexandrie, of Bruxelles, and Alfred Sommerville, of Birmingham, for an improvement or improvements in boots and shoes, and in socks or inner soles for boots and shoes.
1609. James Sedgwick, of Lewisham, for improvements in ship-building.
1610. Mary Ann Stevens, of West Derby-street, Liverpool, for improvements in bonnets.

1611. Charles Harratt, of Royal Exchange Buildings, London, for improvements in fastenings for ship-building.  
 1612. Henry Francis, of the Strand, for an improvement in feeding fuel on to the fire-bars of boiler and other furnaces.

*The above bear date July 21st.*

1613. John Lamb, of Newcastle-under-Lyne, for certain improvements in or applicable to machines for making paper,—being a communication.  
 1614. Thomas Firth, of Huddersfield, and John Wilson, of Mirfield, for improvements in finishing woollen, worsted, silk, and other woven fabrics, and in the apparatus employed therein.  
 1615. James Hadden Young, of College-street, Camden Town, for improvements in gathering grain and other crops, and securing the same.  
 1616. William Septimus Losh, of Wreay Syke, near Carlisle, for improvements in bleaching.  
 1617. John Bainbridge, of Ely-place, for improvements in fire-grates, stoves, furnaces, and other similar contrivances.  
 1618. William Johnson, of Lincoln's-inn-fields, for improvements in the treatment, cleansing, and dyeing of fibrous and textile materials,—being a communication.  
 1619. James Dilks, of Parliament-street, Nottingham, for the application of printed or painted linen, cotton, or other textile fabric, either plain or ornamental, for binding more effectually than heretofore packets or parcels of lace, hosiery, or other articles.

*The above bear date July 22nd.*

1620. Edward Francis Hutchins, of Whitechapel-road, for constructing the cylinders of engines worked by steam, air, or other fluid body, in a circular form on plan; by which means more power is obtained from a given quantity of the said fluid body, in cases where a circular motion is required, than by any other known form of cylinder.  
 1622. John Henry Johnson, of Lincoln's-inn-fields, for improvements in the preparation of silk,—being a communication.  
 1624. George Fergusson Wilson and George Payne, both of Belmont, Vauxhall, for improvements in distilling fatty and oily matters.  
 1625. Auguste Edouard Loradoux Bellford, of Castle-street, for certain improvements in kneading machines,—being a communication.  
 1626. Beaumont Cole, the younger, of Deards End, Knebworth, Hertfordshire, for improved agricultural machinery or apparatus for ploughing and grubbing.

*The above bear date July 24th.*

1627. Francis Preston, of Manchester, for certain improvements in machinery for preparing cotton and other fibrous materials.

1629. William Grundy, of Bury, for certain improvements in the manufacture of drugget,—being a communication.
1630. Ephraim Hallum, of Stockport, for improvements in machines for preparing, spinning, and doubling cotton and other fibrous substances.
1632. Peter Spence, of Pendleton, for improvements in obtaining sulphur from iron pyrites and other substances containing sulphur, and in apparatus for effecting the same.
1633. Thomas Bell, of Don Alkali Works, South Shields, and Henry Scholefield, of South Shields, for improvements in the manufacture of borax.
1634. William Stephens Garland and Josiah Glasson, both of Soho Foundry, Staffordshire, for a means of consuming smoke in furnaces.
1635. Julius C. Hurd, of Medway, Massachusetts, U. S., for an improved machine and process for picking, burring, and cleaning cotton, wool, and for tearing up and reducing old fabrics to be re-spun.
1636. John McGaffin, of Liverpool, for improvements in constructing and applying heads to metal casks and vessels.

*The above bear date July 25th.*

1637. John Lamacraft, of Westbourne Grove, for improvements in envelopes, or means for securing letters, notes, and similar documents.
1638. James A. Cutting, of Boston, United States, for an improved process of taking photographic pictures upon glass, and also of beautifying and preserving the same.
1639. William Church and Samuel Aspinwall Goddard, both of Birmingham, for an improvement or improvements in ordnance.
1640. Adolphus Oppenheimer, of Manchester, for certain improvements in the manufacture of mohair velvet or mohair plush, and worsted velvet or worsted plush.
1641. John Chillcott Purnelle, of Tachbrook-street, Pimlico, for improvements in obtaining and applying motive power.
1642. Auguste Edouard Loradoux Bellford, of Castle-street, for an improved mill for grinding paint and other moist substances, —being a communication.
1643. Louis Christian Koeffler, of Rochdale, for improvements in finishing or polishing yarns or threads.
1644. Edmund Alfred Pontifex, of Shoe-lane, London, and Charles Glassford, of Greenwich, for improvements in obtaining soft lead from hard lead, for the separation of the impurities in hard lead, and for the separation of antimony from these impurities.
1645. Thomas Huckvale, of Choice Hill, near Chipping Norton, for improvements in machinery for gathering crops.
1646. Peter Augustin Godefroy, of King's Mead Cottages, New North-road, for improvements in purifying coal naphtha, and turpentine.

1650. Auguste Edouard Loradoux Bellford, of Castle-street, for improvements in soldering metals,—being a communication.

*The above bear date July 26th.*

1651. George Mumby, of Hunter-street, Brunswick-square, for improvements in bearings, and in the prevention of friction.

1652. Richard Clarke Burleigh, of Northumberland-street, Charing Cross, for improvements in guns, and in the shot or other projectiles fired therefrom.

1654. François Desiré Molvé and Pierre Martin, of Paris, for certain improvements in heating water for feeding boilers of locomotives and marine steam engines.

1655. Samuel Varley, of Stamford, Lincolnshire, for improvements in the construction of reaping machinery.

1656. William Shorrocks, of Farnworth, for improvements in presser flyers, for preparing cotton and other fibrous substances for spinning.

1657. Samuel Frankham, of Greenland-place, Judd-street, for an improvement in the construction of furnaces.

1658. Barton H. Jenks, of Bridesburg, Pennsylvania, for improving the art of weaving; being an improvement in looms for weaving fancy fabrics.

1659. Henry Wickens, of Tokenhouse-yard, for improvements in the means of giving signals on railways, and for other purposes.

1660. Nathaniel Miller, of Guide Bridge, Lancashire, and Robert Graham, of the same place, for certain improvements in the construction of certain parts of the permanent way of railways, commonly called crossings.

1661. Alexander Law, of Glasgow, for improvements in cranes, or lifting and lowering apparatus.

*The above bear date July 27th.*

1662. George Lamb Scott and Samuel Bennett, of Manchester, for improvements in springs for pressing together rollers for mangling and other purposes.

1663. Adam Guild, of Salford, and John Pendlebury, the younger, of Manchester, for improvements in apparatus for scouring or bleaching.

1665. Richard Johnson, of Manchester, for improvements in coating and insulating wire.

1666. Francis Morton, of Liverpool, for certain improvements applicable to girders or rafters, to be used in the construction of roofs, bridges, buildings, and other erections.

1667. Amable Hippolyte Petit, of Paris, for an improved mode of joining pipes.

1668. Samuel Clift, of Manchester, for improvements in making paper, pasteboard, and papier-mâché.



1669. James Gilbertson, of Hertford, for an improvement in supplying air above the fuel in furnaces.

*The above bear date July 28th.*

1670. Robert John Keen, of Liverpool, for improvements in the mariner's compass.

1672. Edmund Burke, of Upper Thames-street, and Alexander Southwood Stocker, of the Poultry, for certain improvements in the manufacture of metallic tubes and such like articles.

1674. William Henry Smith, of Bloomsbury, for certain improvements in the permanent way of railways.

1675. Gustave Emile Bernard Collason, of Paris, for certain improvements in the means for arresting or checking the progress of trains on railways,—being a communication.

1676. John Yuil Borland, of Manchester, for improvements in machinery for preparing and spinning fibrous materials.

1677. John Fawcett, of Gateshead, for an apparatus for regulating and economizing the consumption of gas generally, but more particularly when employed for the purposes of illumination.

1678. George Henry Ingall, of Warnford-court, for improvements in elastic bands for holding books and papers.

1681. Henry Walduck, of Warwick-court, Gray's-inn, for improvements in propelling vessels.

1682. George Thatcher, of Welton Midsomer Norton, Somerset, for improvements in the manufacture of woven fabrics, yarn, cordage, ropes, paper, and pasteboard, by the application of a material not hitherto used for such purposes.

*The above bear date July 29th.*

1684. Henry Adams, of Hatcham, Deptford, for a revolving ventilator.

1685. Henry Green, of Liverpool, for improved apparatus applicable to the hanging of doors, gates, and windows, and for closing or holding open the same when required.

1686. Joseph Green and William Jackson, both of Leeds, for improvements in mortising machines.

1688. Thomas Ridgway Bridson, of Bolton-le-Moors, for improvements in preparing cotton for manufacturing purposes.

*The above bear date July 31st.*

1689. Edward Gillman, of Twickenham, for improvements in the manufacture of paper, papier-maché, and other similar articles, from certain vegetable substances.

1690. Jules Frédéric Bouneau, of Paris, for improvements in propelling ships.

1691. Thomas Evans, the younger, of Lewisham, for certain improvements in the rigging of ships, and all other vessels using or carrying sails, whether propelled by steam or otherwise, or on whatsoever sea, river, or other water navigated.

1692. Christopher Ridout Read, of Moorgate-street, for improvements in slide-valves of steam-engines,—being a communication.
1693. John Mc Gaffin, of Liverpool, for an improvement in the manufacture of sheet-metal pipes.
1694. William Edward Newton, of the Office for Patents, 66, Chancery-lane, for improvements in the construction of repeating fire-arms,—being a communication.
1695. Richard Archibald Brooman, of Fleet-street, for improvements in machinery for dressing flax, hemp, and other like fibrous substances,—being a communication.
1696. Thomas Edward Merritt, of Maidstone, for improvements in apparatus for taking photographic pictures in the open air.
1697. John Simon Holland, of Woolwich, for improvements in locks.

*The above bear date August 1st.*

1698. James Griffiths, of Wickham Market, Suffolk, for a new or improved lever-bit for horses.
1699. Samuel Lees, of Salford, for improvements in machinery or apparatus to be used in purifying gas for illumination.
1700. George Holworthy Palmer, of Adelaide-road, Hampstead, for improvements in guns, gun-carriage and appurtenances, and in the manipulation or working of guns,—being a communication.
1701. Cléo Chevron, of Paris, for improvements in looms for weaving.
1702. Joshua Brown, of Stockport, for improvements in the method of consuming smoke.
1703. Paul Garavaglia de Soresina, of Bedford-row, for improvements in treating flax and hemp.

*The above bear date August 2nd.*

1705. William Rye and William Crowther, both of Oldham, for improvements in steam-engines.
1707. William Gossage, of Widnes, for improvements in the manufacture of certain kinds of soap and other detergent compounds.

*The above bear date August 3rd.*

1709. Louis Player Miles, of Ravensbourne-park, Lewisham, for improvements in the construction of locks.
1711. Samuel Lawrence Taylor, of Cottonend, Bedford, for improvements in constructing and arranging the beaters and dressing machinery of thrashing-machines.
1713. Alfred Kortright, of James-street, Adelphi, for improvements in marine and surveying compasses.

*The above bear date August 4th.*

1715. Auguste Boissonneau, of Paris, for improvements in artificial eyes.

1717. Charles Frederick Stansbury, of Cornhill, for improvements in locomotive and steam-boiler furnaces,—being a communication.
1719. Charles Frederick Stansbury, of Cornhill, for improved air-tight vessels,—being a communication.
1721. James Gathercole, of Eltham, Kent, for improvements in bordering, or producing devices upon the edges of envelopes, letter-paper, or other articles of stationery.

*The above bear date August 5th.*

### **New Patents.**

*Sealed under Patent Law Amendment Act, 1853.*

- |                                   |                                     |
|-----------------------------------|-------------------------------------|
| 1853.                             | 364. William Asbury.                |
| 992. Wm. Tillie & John Henderson  | 367. Thomas Jennings.               |
| 1854.                             | 371. C. F. Varley.                  |
| 204. H. Tendall and W. St. Clair  | 373. J. Greenwood and R. Smith.     |
| Trotter.                          | 378. Thomas Fawcett, jun.           |
| 207. Wm. Partington.              | 379. T. T. Macneil.                 |
| 242. Wm. Malam.                   | 386. Robert Holt.                   |
| 246. C. B. A. Chenot.             | 394. Bashley Britten.               |
| 247. Henry Wickens.               | 396. Nicholas Riggensbach.          |
| 256. A. Daniel.                   | 404. Thomas Towers.                 |
| 266. F. H. Sykes.                 | 411. J. Gedge.                      |
| 275. P. J. Meeûs.                 | 412. Victor Pernollet.              |
| 280. Wm. Little.                  | 417. James Smith.                   |
| 283. Thomas Sullivan.             | 419. A. Dixon.                      |
| 286. R. J. Mary'on.               | 420. A. Dixon.                      |
| 287. A. L. N. Comte Vander Meere. | 426. E. Taylor.                     |
| 292. Peter Trumble.               | 427. D. Assanti.                    |
| 294. James Murdoch.               | 432. Thos. Settle and Peter Cooper. |
| 297. Henry Olding.                | 433. Adolphus Oppenheimer.          |
| 307. G. W. Knocker.               | 436. Charles Walker.                |
| 308. John Perry.                  | 437. T. D. Pruday.                  |
| 313. F. Vouillon.                 | 446. C. Cowper.                     |
| 314. J. Samuel & A. W. Makinson.  | 447. C. Cowper.                     |
| 316. E. Boileau.                  | 454. T. Forsyth.                    |
| 318. P. J. Meeûs.                 | 455. A. E. L. Bellford.             |
| 322. William Dray.                | 459. C. W. Siemens.                 |
| 329. Joseph Johnson.              | 463. C. F. Bekaert.                 |
| 334. A. J. B. L. Marcescheau.     | 468. W. E. Staite.                  |
| 337. J. Jennings, jun.            | 479. F. S. Thomas.                  |
| 340. J. F. Dupont de Bussac.      | 481. A. E. L. Bellford.             |
| 341. George Ayres.                | 490. T. J. Johnson.                 |
| 343. Thomas Edwards.              | 498. T. H. Ewhank.                  |
| 345. D. Campbell and J. Barlow.   | 500. S. Roussel.                    |
| 346. E. Clegg and E. Leach.       | 504. T. Truscott and T. P. Baker.   |
| 358. S. Perkes.                   | 505. J. S. Holland.                 |
| 361. P. O'Connor.                 | 516. T. and R. Yates.               |
| 362. J. Hossell.                  | 518. L. Tindall.                    |
| 363. J. Potter.                   | 521. W. E. Newton.                  |

532. J. K. Stuart.  
 535. J. Galloway.  
 540. P. A. de St. Simon Sicard.  
 547. Thomas Dunn.  
 555. W. S. Losh.  
 560. John Blair.  
 573. William Peace.  
 576. P. A. Le Comte de Fontaine-  
       moreau.  
 600. Benjamin Latchford.  
 606. George Hopper.  
 612. Johnson Hands.  
 618. T. S. Holt and C. H. Holt.  
 622. Alfred Trueman.  
 623. William Weatherley and Wil-  
       liam Jordan.  
 632. James Cavanah.  
 633. John Lilley.  
 638. T. J. Herapath.  
 651. Edouard de Mars.  
 684. Frederic Seiler.  
 686. Moses Poole.  
 688. James Newman.  
 690. Richard Montgomery.  
 695. John Jeyes.  
 710. G. Collier.  
 724. F. W. Harrison and H. G. W.  
       Wagstaff.  
 748. A. E. L. Bellford.  
 762. Wm. Gossage.  
 846. James Childs.  
 861. Samuel Colt.  
 878. A. E. L. Bellford.  
 886. D. Tannahill.  
 912. George Jones.  
 931. James Warren.  
 960. Joseph Barling.  
 969. Christopher Kingsford.  
 976. James Hamilton.  
 982. Alfred Trueman.  
 984. W. E. Newton.  
 1015. J. G. Jennings.  
 1017. J. G. Jennings.  
 1052. Henry Doulton.  
 1062. Moses Poole.  
 1063. C. W. F. Aubusson.  
 1064. Moses Poole.  
 1066. A. E. L. Bellford.  
 1076. T. G. Shaw.  
 1082. R. Scott and T. Rowland.  
 1088. G. E. Dering.  
 1090. T. W. Miller.  
 1128. W. and A. Crighton.  
 1129. R. Crosland, Wm. Holiday,  
       and John Heaton.  
 1138. A. P. Rochette.  
 1158. J. Lillie.  
 1160. Thomas Ball.  
 1168. J. W. Jeakes.  
 1174. Samuel Sweetser.  
 1180. Joseph Hipkiss.  
 1196. Henry Doulton.  
 1197. Michael Scott.  
 1201. E. Loysel.  
 1217. J. T. Chance.  
 1219. Joseph Robinson.  
 1220. Owen Rowland.  
 1226. M. Poole.  
 1227. Egmont Websky.  
 1228. Isaac Taylor.  
 1231. P. A. Le Comte de Fontaine-  
       moreau.  
 1239. A. F. Goodnow.  
 1241. A. G. Barham.  
 1244. W. Crum and P. Stewart.  
 1249. Andrew Spottiswoode.  
 1253. W. J. Baillie.  
 1254. W. T. Parkes.  
 1257. N. L. ough.  
 1259. C. A. Perpigna.  
 1274. Thomas Bramwell.  
 1276. J. L. Hancock.  
 1277. J. Currie and R. Young.  
 1296. J. Hargrave.  
 1298. F. Martini.  
 1306. R. Hornby.  
 1309. Charles Hargrove.  
 1311. F. Martini.  
 1314. W. G. Pidduck.  
 1316. Thomas Parramore.  
 1317. David Lowe.  
 1318. G. J. Hinde.  
 1338. David Bogue.  
 1347. N. Clayton & J. Shuttleworth.  
 1348. W. T. Monsani.  
 1408. C. Beale and J. Latchmore.  
 1410. William Yates.

\*\*\* For the full titles of these Patents, the reader is referred to the  
 corresponding numbers in the List of Grants of Provisional Protections.

CELESTIAL PHENOMENA FOR SEPTEMBER, 1854.

D. H. M.		D. H. M.	
1	Clock after the ☉ 0m. 5s.	13	Saturn, R. A., 4h. 58m. dec. 20. 58. N.
—	☽ rises 3h. 41m. A.	—	Uranus, R. A., 2h. 56m. dec. 16. 25. N.
—	☽ passes mer. 7h. 14m.	—	Mercury passes mer. 0h. 1m.
—	☽ sets 10h. 44m.	—	Venus passes mer. 22h. 32m.
11 23	♃'s first sat. will em.	—	Mars passes mer. 3h. 4m.
2 13 25	♃ in conj. with the ☽ diff. of dec. 3. 32. N.	—	Jupiter passes mer. 7h. 47m.
4	Occul. 35, Capricorni, im. 11h. 11m., em. 12h. 18m.	—	Saturn passes mer. 17h. 27m.
4 4	☽ in Perigee.	—	Uranus passes mer. 15h. 25m.
10 8	♃'s second sat. will em.	14 6 30	☽ in ☐ or last quarter
5	Clock after the ☉ 1m. 22s.	15	Clock after the ☉ 4m. 49s.
—	☽ rises 6h. 42m. A.	—	☽ rises 10h. 37m. A.
—	☽ passes mer. 11h. 19m.	—	☽ passes mer. 6h. 38m. M.
—	☽ sets 2h. 37m. M.	—	☽ sets 3h. 30m. A.
2 35	♄ greatest hel. lat. N.	16 4	☽ in Apogee
8 21	♃'s fourth sat. will im.	17 9 42	♃'s first sat. will em.
6	Pallas stationary.	19 8 54	♃'s third sat. will em.
9 18	Ecliptic oppo. or ☉ full moon.	19 21 26	♃ in conj. with the ☽ diff. of dec. 4. 6. S.
8 1 12	♄ in ☐ with the ☉	20	Clock after the ☉ 6m. 34s.
10	Occul. σ Aretis, im. 16h. 35m. em. 17h. 37m.	—	☽ rises 1h. 15m. M.
—	Clock after the ☉ 3m. 4s.	—	☽ passes mer. 9h. 54m. M.
—	☽ rises 8h. 3m. A.	—	☽ sets 5h. 39m. A.
—	☽ passes mer. 2h. 36m. M.	21 22	☽ in Perihelion.
—	☽ sets 9h. 40m.	22 8 0	Ecliptic conj. or ● new moon.
7 47	♃'s first sat. will em.	10 19	♄ in conj. with the ☽ diff. of dec. 3. 17. S.
22 58	♄ in conj. with the ☽ diff. of dec. 0. 20. N.	21 13	☉ enters Libra, Autumn com.
11 23 2	♄ in sup. conj. with the ☉	25	Clock after the ☉ 7m. 57s.
13 8 28	♄ in conj. with the ☽ diff. of dec. 3. 38. S.	—	☽ rises 8h. 6m. M.
13 43	♃ stationary.	—	☽ passes mer. 1h. 35m. A.
—	Mercury, R. A., 11h. 30m. dec. 4. 53. N.	—	☽ sets 6h. 51m.
—	Venus, R. A., 10h. 0m. dec. 13. 17. N.	15 44	♄ in conj. with the ☽ diff. of dec. 1. 6. S.
—	Mars, R. A., 14h. 33m. dec. 15. 43. S.	26 6 7	♃'s first sat. will em.
—	Vesta, R. A., 13h. 25m. dec. 3. 44. S.	27	Ceres stationary.
—	Juno, R. A., 13h. 3m. dec. 0. 53. S.	22 13	♄ stationary.
—	Pallas, R. A., 18h. 52m. dec. 11. 46. N.	28 14 8	♄ in the descending node.
—	Ceres, R. A., 20h. 38m. dec. 31. 4. S.	29 0 38	☽ in ☐ or first quarter.
—	Jupiter, R. A., 19h. 16m. dec. 22. 45. S.	7 16	♃'s second sat. will em.
		20 15	♃ in conj. with the ☽ diff. of dec. 3. 44. N.
		30 . . .	Occul. ω Sagittarii, im. 6h. 16m. em. 7h. 31m.
		—	Occul. A. Sagittarii, im. 7h. 54m. em. 9h. 7m.

J. LEWTHWAITE, Rotherhithe.

THE  
LONDON JOURNAL,  
AND  
REPERTORY  
OF  
Arts, Sciences, and Manufactures.

---

CONJOINED SERIES.

---

No. CCLXXIV.

---

RECENT PATENTS.

To JAMES NASMYTH, of *Patricroft, in the county of Lancaster, engineer, for improvements in the pistons and piston-rods of steam-hammers and pile-drivers, and in the parts in immediate connection therewith.*—[Sealed 29th October, 1853.]

THIS invention consists, firstly, in constructing the piston-rod glands of steam-hammers and pile-drivers in two or more pieces, for the purpose of allowing the knob at the lower end of such piston-rod, or the projection to which the piston is secured, to pass through the hole in the cylinder bottom; secondly, in improved modes of connecting pistons to the piston-rods of steam-hammers and pile-drivers; thirdly, in making the piston, piston-rod, and knob at the lower end thereof, in one piece; and, lastly, in an improved packing-ring for the pistons of steam-hammers and pile-drivers.

In Plate VII., fig. 1, represents an elevation of a steam-hammer, with the improvements applied thereto. *a*, is the framing; *b*, the hammer-head or block; *c*, the cylinder; and *d*, the cylinder bottom. These parts are constructed in the usual manner. *e*, is the piston, which may be packed according to any of the methods now in use, or with the improved packing-ring *f*, which will be explained hereafter. *g*, is the piston-rod, to which the piston is attached in the following manner:—The upper part of the piston-rod at *g*<sup>1</sup>, is made considerably larger than the body of the rod, and the space between *g*<sup>1</sup>, and *g*<sup>2</sup>, is turned conical. The upper end of the piston-rod, previous to rivetting the piston on it, is cylindrical, as shewn by dotted lines. The piston having been accurately bored out, is placed upon the conical part between *g*<sup>1</sup>,

and  $g^2$ , and the upper end of the rod is then hammered until it fills up the space between  $g$ , and  $g^3$ . By this means the piston is so securely fastened to the piston-rod that no injurious effect is produced upon them by the violent concussive action to which these parts of steam-hammers are subjected when at work; whereas, when the piston is connected to the piston-rod by any of the usual methods, it frequently gets loose. At the lower extremity of the piston-rod is forged the knob  $g^4$ , which bears upon the plate  $h$ , and serves to connect the rod to the hammer-head, as in steam-hammers now in use. The packing-ring  $i$ , is tightened on the knob  $g^4$ , by the wedge-keys  $j$ ; but, as both extremities of the piston-rod are forged solid with the rod, and are more in diameter than the part on which the ring  $i$ , fits, it is evident that this ring must be put together in two halves, as shewn in the perspective view, fig. 2. For the same reason the stuffing-box gland-ring  $k$ , and gland  $l$ , must also be put together in two parts, as shewn in the perspective views, figs. 3, and 4. The gland  $l$ , is furnished with a tenon or dowell; so that when the halves are clasped together around the piston-rod, they act simultaneously on being screwed up by the ordinary tightening screws. Fig. 5, is a detached view of a piston and piston-rod, shewing another mode of fastening them together. Fig. 6, represents the piston and piston-rod forged together, as has been done before in steam-hammers.

Figs. 7, and 8, are two sections of the improved packing-ring  $f$ , for the pistons of steam-hammers and pile-drivers. The packing-ring is triangular in section, and may be cut in two, so as to be able to get it into the recess of the solid piston. The sharp angle of the triangle is placed downwards, so that the upward motion of the piston has a tendency to bring the packing-ring against the interior of the cylinder, or into the proper position for forming a steam-tight joint, as shewn in fig. 7; whereas, when the piston descends, the friction of the ring against the interior of the cylinder draws the ring into the position shewn in fig. 8,—thereby relieving the joint, and allowing the piston to descend freely.

The patentee claims, First,—constructing the piston-rod stuffing-box glands of steam-hammers, and pile-drivers, in two or more pieces, in the manner and for the purposes hereinbefore described. Secondly,—the improvements in connecting pistons to their piston-rods, as shewn in figs. 1, and 5. Thirdly,—making the piston, piston-rod, and knob marked  $g^4$ , in one piece, as shewn in fig. 6. And, Lastly,—the improved packing-ring for the pistons of steam-hammers and pile-drivers, as shewn and described.

To JOHN HIPPLISLEY, of Stoneaston, in the county of Somerset, Esq., for improvements in steam-engines, suitable for agricultural purposes, and to locomotion on common roads.  
—[Sealed 19th May, 1853.]

THIS invention consists, first, in the application to locomotive engines, to be employed otherwise than on railways, of a fly-wheel or wheels, with intermediate slow motion gearing, for the purpose of applying an accumulation of power to the driving-wheels. And, second, in guiding such engines by the application of the power of the engine to one or other of the driving-wheels, and disconnecting it wholly or partially from the opposite driving-wheel. And, third, in the employment, with the method of guiding by the alternate action of the driving-wheels, of a wheel or wheels which shall follow the direction of the driving-wheels without separate guidance.

In Plate VIII., fig. 1, is a side view of an engine constructed according to this invention; and fig. 2, a plan of part of the same. *a*, is a stout framing for supporting the engine. *b*, is a boiler. *c*, a steam cylinder of ordinary construction connected to a fly-wheel *d*. The fly-wheel shaft carries a pulley *e*, on each end. *f, f*, are the driving-wheels. On each driving-wheel is fixed a cog-wheel *g*, which gears into an intermediate toothed wheel *h*, and drives another toothed wheel *i*, which is fixed to and mounted on the same axis as a large pulley *k*, which receives motion through an endless band *a\**, passed over the pulley *e*. The endless band is of such a length as not to cause the pulley *k*, to revolve unless tightened by the lever *l*, and friction wheel *m*. The arrangements of gear being the same on both sides of the locomotive engine, either or both of the driving-wheels can be connected with or disconnected from the power of the engine, by means of the tightening lever and friction wheel. Each tightening lever carries a friction-break *n*, which acts on the boss of the toothed wheel *i*, by pulling back the lever; when the rotation of the driving-wheels through the toothed wheels *g, h*, and *i*, can be checked or altogether stopped. It will be seen that the turning or guiding of the locomotive can thus be effected by the direct action of the engine; for whereas, if the engine acts equally on both driving-wheels, the locomotive will proceed in a straight line; so if it acts on one driving-wheel only, while the other is stayed or altogether stopped, the locomotive will turn aside. It also follows, from the arrangements hereinbefore described, that, by the due observance of the proportions of the cog and toothed wheels and pulleys, any accumulation of power, at the expense



of speed, may be applied to the driving-wheels. The driving-wheels are so placed as to support the greater part of the locomotive; but the after part of the locomotive is borne on a pair of wheels turning on a pivot, in a similar manner to the ordinary fore wheels of a road waggon. These wheels follow the driving-wheels, without requiring any separate guidance, when the locomotive is advancing with the driving-wheels in front. But in order to provide for guiding the carriage, in the event of its being required to advance in the contrary direction, a toothed segment *o*, is connected to the axle of the wheels, and guides them in any required direction by turning a pinion *p*, which gears into the teeth of the segment *o*.

The patentee claims, First, the means hereinbefore described of accumulating power in the driving-wheels. Secondly,—the guiding of locomotive engines by the power of the engine applied to one or other of the driving-wheels, as hereinbefore described. And, Thirdly,—the employment of a wheel or wheels which follow the direction of the driving-wheels, without requiring any separate guiding, in combination with the guiding of the carriage by the alternate action of the driving-wheels, as hereinbefore described.

---

*To WILLIAM BECKETT JOHNSON, of Manchester, manager for Messrs. Ormerod and Son, engineers and ironfounders, for improvements in steam-engines, and in apparatus for indicating the pressure of steam.—[Sealed 5th November, 1853.]*

THE first part of these improvements, shewn in side elevation at fig. 1, Plate VII., relates to engines in which the working cylinder is attached to a vertical framing, and consists in so constructing such framing as to admit of the cylinder *a*, being attached to its outside flange or face *b*, and also in carrying the strengthening portion *b*<sup>1</sup>, which extends to the base in the longitudinal direction of the crank-shaft *c*. Motion is given to the crank *d*, by means of the usual piston and connecting-rod. In this arrangement the cylinder is shewn attached to the upper part of the frame; but the cylinder may be attached to the lower part, and the crank-shaft end revolve in a bearing formed in the upper part of the frame.

The second improvement refers to portable engines, and is shewn in transverse section at fig. 2, in which the steam-cylinder *a*, is attached, in a vertical position, to a boiler *b*, having furnaces or tubes placed horizontally within it. The

governor-shaft *c*, passes through a tube *d*, fixed in the boiler, and is connected with the crank-shaft *e*, by means of a pair of wheels *f, f*. The shaft *c*, is shewn to give motion to an ordinary governor, but it may, after the same manner, actuate a governor or regulator of a different description.

The third improvement is shewn, in side elevation, at fig. 3, and consists in working a crank *a*, by means of a pin *b*, placed upon or fixed to the excentric rod *c*, for the purpose of giving motion, by suitable connections with the shaft *d*, to a governor or force-pump. *e*, is the main crank-shaft; and *f*, the excentric, for actuating the rod *c*; the opposite end of the rod *c*, (which is shewn broken off) being connected with suitable apparatus for giving motion to the slide-valves or other moving parts of the engine. In the crank *a*, is formed a slot *g*, lengthways with the crank, so as to allow the pin *b*, to move in the elliptical or other line of motion it will describe.

The fourth improvement relates to a method of indicating the pressure of steam, and is shewn in vertical section at fig. 4. One peculiarity consists in causing a piston *a*, within a cylinder *b*, after it has overcome a certain amount of retaining power, as that of a spring *c*, to operate by means of a chain *d*, or other convenient connection, so as to open the valve *e*, and thus establish a communication between the steam and a whistle *f*, immediately the valve *e*, is opened by the piston just described. Steam is admitted into the cylinder *b*, through the aperture *g*. Another point of novelty under this part of the invention consists in causing the rod *h*, of the piston *a*, arranged as before described, to act upon the shorter arm *i*, of a bell-crank lever, so as to turn it upon the centre *k*, and thereby move the longer arm *l*, in order to point out, upon a scale *m*, the pressure of the steam.

The patentee claims, Firstly—in direct-action vertical engines—attaching the cylinder to an outside flange of the main framing,—such framing having its strengthening part continued horizontally in the direction of the main crank-shaft. Secondly,—in portable engines—passing the governor spindle or shaft through the boiler. Thirdly,—giving motion to a crank by means of a pin fixed to the excentric rod, and working a governor or force-pump from such crank. Fourthly,—in steam-pressure indicators, causing a piston working within a cylinder to act upon a valve, so as to form a communication with any suitable signal whistle. Fifthly,—connecting the short end of a bell-crank lever with the piston of a steam-pressure indicator,—the longer end of the lever being used to indicate, by a suitable scale, the pressure of the steam.

To HARRY BENTLEY, of *Salford, in the county of Lancaster, roller and spindle-maker and millwright, for improvements in steam-boilers, and in the method of setting or fixing the same.*—[Sealed 22nd October, 1853.]

THIS invention of improvements in steam-boilers consists in forming, in the centre of each flue, a vertical tube, through which the water passes; which flues are so connected at the back part or extremity of the boiler, that the heat or flames from them will meet in the combustion-chamber, and then pass through the brick flues to the chimney in the ordinary manner. Additional heating surface is thus gained by the vertical tubes; and, by the brick flues, the smoke is partially consumed, and a considerable saving of fuel effected.

In Plate VII., fig. 1, is a sectional plan of the improved boiler, provided with two flues, and fig. 2, a transverse section thereof. Fig. 3, is a transverse section of a three-flued boiler, with the improvements applied thereto; and fig. 4, is a sectional plan. *a*, represents the outer casing of the boiler; *c*, the fire-bars; *d*, the flues; *e*, the vertical tubes containing water; and *f*, the stays to strengthen different parts thereof. It will be easily understood, that the flames or heat from the fire, traversing the flues, communicate heat to the vertical tubes, and heat or evaporate the water contained therein; and the heat or flames from the flues (however numerous they may be) meeting and concentrating in a chamber at the back or extremity of the boiler, a combustion of the gases is caused; and then passing through the brick flues, a further combustion is effected; thus consuming, or partially consuming, the smoke, and causing a very great saving of fuel.

The patentee claims the construction of the steam-boiler with vertical tubes, as herein described and illustrated.

---

To ROBERT ROUGHTON, of *Woolwich, in the county of Kent, engineer in the Royal Navy, for an improvement in steam-boilers; which is applicable to other vessels for containing compressed air, vapour, or gas.*—[Sealed 7th November, 1853.]

THIS invention consists in fixing upon, or in connection with, a steam-boiler or other vessel for containing compressed air, vapour, or gas, a circularly-formed dome or chamber, of any suitable material; the dimensions of which dome are such that it will burst and relieve the boiler or other vessel when

any undue pressure of the steam, vapour, or gas, is produced within it, either by accident or otherwise.

The figure in Plate VII., represents one method of carrying this invention into effect. *a*, is a section of the upper part of a steam-boiler. *b*, is a brass cylinder, having two flanges *c*, *d*; the lower one of which, *c*, is firmly screwed down to the boiler *a*, and the upper part of which, *d*, is screwed to the lower flange *e*, of another cylinder *f*, which is formed of zinc of such thickness that it will burst when the internal pressure exceeds a definite amount. The former of these cylinders, *b*, is two inches in diameter, and the latter, *f*, four inches. *g*, is a cover or bonnet, screwed down upon the upper flange *h*, of the cylinder *f*, in such manner that, when the latter bursts, it may be readily removed, and the said cover or bonnet *g*, be immediately screwed down upon the flange *a*, of the cylinder *b*, in order to make the boiler effective again until a new zinc cylinder can be conveniently applied.

The dome is to be fixed to the boiler in such position that the steam shall be permitted to escape only in the most convenient direction; a case or cover, with an aperture on one side of it, being, when necessary, placed over it for this purpose. In locomotives the aperture for this case or cover may be placed towards the funnel; and in steamers it may lead into the air-casing that surrounds the funnel. It would also be advisable that the whistle in constant use in locomotives, or a pipe connected to the steam-gauge or water-glass in steamers, should communicate with the apparatus described, in order to guard against the danger of designing persons choking the passage from the boiler to the zinc cylinder from within the boiler.

These safety-domes may be made spherical, spheroidal, cylindrical, or of any other circular form; but the cylindrical form, previously described, will probably be found the most convenient: they may also be formed of any suitable substance, the strength of which has been ascertained.

The area of the orifice, covered by a dome of the foregoing description, must not be less than will afford sufficient escape for the steam, as may be determined by a rule to be described hereafter; but it will generally be convenient to make the area much larger than the minimum size indicated by the said rule.

The dimensions of the zinc, or of any other corresponding cylinder, necessary to sustain a given pressure, may be very readily determined. Let the following be taken as an example:—Required the dimensions of a safety-dome for a

locomotive boiler, which can convert 200 cubic feet of water per hour into steam of a pressure of 100 lbs. per square inch. Let the material be zinc, whose ultimate strength is one ton, or 2240 lbs. per square inch of section; and let the dome be of a cylindrical form, and one-eighth of an inch in thickness. Then the pressure that will burst this dome, supposing it to be one inch deep, will be  $2240 \text{ lbs.} \times \frac{1}{8} \times 2 = 560 \text{ lbs.}$ ; and if the dome is required to burst when the internal pressure of the steam is 140 lbs. per square inch, and not at any less pressure (lest a small and uninjurious increase of pressure above the 100 lbs. should burst the dome, and thereby give unnecessary trouble), then  $\frac{560}{140} = 4$  inches, the required diameter of the cylindrical dome. This dome might be proved, by actual experiment, to be capable of sustaining 120 lbs. pressure per square inch, to ensure that it would not burst with much less than the desired pressure.

The following is the rule hereinbefore referred to for determining the area of the orifice that will suffice for the escape of the steam:—

Let  $a$  = area of orifice in square inches.

„  $w$  = the number of cubic feet of water evaporated per hour.

„  $f$  = the logarithm of the sum of the steam and atmospheric pressures, *minus* the logarithm of the atmospheric pressure.

„  $c$  = 98, a number that has been determined by experiment.

Then  $a = \frac{w}{fc}$  is the formula required.

In the example previously investigated,  $w = 200$ , and  $f = \log. (100 + 15) - \log. 15 = \cdot 89$ . Therefore  $\frac{w}{fc} = \frac{200}{98 \times \cdot 89} = 2\cdot 29$  square inches. Therefore two inches will fully suffice for the diameter of the escape orifice.

The patentee claims the adaptation to steam-boilers and vessels, for containing compressed air, vapour, or gas, of a dome or chamber, of any suitable circular form and material that will guarantee a finite strength, and of such dimensions that it will burst with a less internal pressure than the vessel itself, and thus relieve the said vessel whenever an undue pressure occurs, either from the derangement of the safety-valve or from any other cause.

---

To JOHN SEAWARD, of the Canal Iron Works, Poplar, in the county of Middlesex, engineer, for improvements in marine engines.—[Sealed 9th February, 1853.]

It has been heretofore the practice in building marine steam-engines to place the air-pump and condenser together in close conjunction; and, as it is frequently the case that the air-pump is required to be situated at some distance from the cylinders, the consequence is that, the condenser being placed close to the air-pump, the spent steam has to be conveyed from the cylinders to the condenser by means of a passage pipe of considerable length and diameter; a disposition of parts which in general is not only highly inconvenient, but also prejudicial to the rapid condensation of the spent steam. Now, this invention has for its object to remove these inconveniences, which is effected by disconnecting or separating the condenser entirely from the air-pump, which latter is placed in any convenient situation where a ready connection with some moving part of the engine can be obtained to work the bucket; while the condenser is placed in close contiguity to the cylinders, so that the spent steam may have the shortest possible distance to travel, to be acted upon by the injection water within the condenser. A pipe of convenient size is employed to convey from the bottom of the condenser to the foot-valve of the air-pump the water arising from the condensation of the steam, together with the injection water, and the uncondensable air and gases, which will be drawn up by the bucket and discharged through the hot well in the usual way. And, although this invention is more particularly adapted for steam-engines employed in driving screw and such like propellers, it is also applicable to other descriptions of marine engines.

In Plate VIII., fig. 1, is a cross section of a pair of engines, such as are frequently employed in screw propelling; fig. 2, is a longitudinal section taken between the two cylinders; and fig. 3, is a plan view.  $g^1, g^{11}$ , are the two steam cylinders placed side by side in a horizontal position;  $h$ , is the condenser, which, it will be observed, is placed partly between and partly upon the two cylinders, and has two inlet passages at  $i^1$ , and  $i^{11}$ , to admit the spent steam from the slide-chests  $k^1, k^{11}$ , of the steam cylinders.  $j^1, j^{11}$ , are the slide valves; and  $l^1, l^{11}$ , the two steam-pipes.  $m$ , is the air-pump, with its bucket  $m^*$ , which is worked by a short crank placed on the end of the main shaft;  $n$ , is the foot-valve;  $n^*$ , the head valve in the hot well;  $o$ , and  $p$ , the overflow or discharge-pipe; and  $r$ , is the pipe from the bottom of the condenser to the foot-valve

*n*, of the air-pump. The water from the condenser will be drawn up by the bucket *m*\*, and discharged through the hot well *o*, in the usual way. The air-pump *m*, is one of the ordinary form employed with screw-propeller engines; but the invention may be used with any other suitable form of air-pump.

Fig. 4, is a longitudinal section, and fig. 5, a plan of a horizontal double-acting air-pump, which may be employed with advantage. *s*, is the working barrel of the pump, with its bucket *t*; *v*<sup>1</sup>, *v*<sup>11</sup>, are two foot-valves; and *w*<sup>1</sup>, *w*<sup>11</sup>, the two head or delivery-valves, which discharge into the hot well *x*; *y*, is the overflow pipe of the hot well; and *z*, the pipe which conveys the water and uncondensed gases from the bottom of the condensers to the foot-valves *v*<sup>1</sup>, *v*<sup>11</sup>, of the air-pump. The condenser *h*, may be of any convenient form, and placed in any suitable position; but should always be in as close proximity to the cylinders as possible.

The patentee claims the separation or disconnection of the air-pump from the condenser, and the placing of the latter in close contiguity to the cylinder or cylinders, while the former is situated in any convenient position for working the bucket by a suitable motion from the engines, and connected with the condenser by an intermediate or connecting pipe in manner and for the purpose hereinbefore described.

---

*To JOHN STEVEN, of Edinburgh, railway-carriage builder, for an improved axle-box for railway carriages and waggons.—[Sealed 22nd August, 1853.]*

THIS invention relates, in the first place, to the construction of axle-boxes, suitable for railway carriages, waggons, and other vehicles, each in one single piece or mass,—the body of the axle-box being cast or formed in one piece with its under cover, instead of being in two separate pieces, as in the arrangement usually adopted in such works. The axle-boxes so made are of superior compactness and substantiality; and, when cast, they are at once ready for use, without requiring any fitting of the under cap or other details.

Secondly, to the formation of axle-boxes with recesses or cavities on the upper sides or tops thereof, for the reception of the bearing-springs,—the springs being secured, at their central portions within the recesses, by means of strong buckles or clasps, instead of uniting them to the boxes by means of the ordinary ties or clips. The weight of the car-

riage or waggon is sufficient to keep the springs in their places in the box recesses; and hence the usual fastening details are quite unnecessary.

Thirdly, to a peculiar construction of the brass bearings and grease-chambers of axle-boxes; by means of which arrangement the brass is kept in immediate contact with the grease or lubricating matter. Such brasses are formed so as to extend upwards to the part containing the grease,—cylindrical holes being provided for the passage of the grease to the rubbing surfaces.

In Plate VIII., fig. 1, is a longitudinal vertical section of the box, with its brass bearing and bearing-spring,—the axle-journal being represented in elevation within it; and fig. 2, is an inside elevation of the axle-box without its spring, corresponding to fig. 1. *a*, is the axle-box, which is represented as cast in a single piece, with its covered portion *b*,—a recess being formed thereon for the reception of the central portion of the bearing-spring *d*. The spring is embraced, at its centre, by a buckle or clasp-piece *e*,—this piece being accurately fitted to the recess in the top of the box, so as to bear firmly therein when pressed by the load above. The upper part *f*, of the axle-box contains the lubricating matter, which is covered up by the hinged door or lid *g*. On each side are the usual vertical grooves, fitting to the horn-plates of the carriage or waggon, as guides for the vertical play of the box under the spring action. The brass bearing *i*, has a central grease passage *j*, through which the lubricating matter passes to the journal surface. The brass is carried up, at this part, by recessing it into the bottom of the division forming the grease-chamber; so that the brass itself is brought into actual contact with the lubricating matter above; thus considerably facilitating the passage of the grease to the working surfaces. When the length of the journal is considerable, more than six inches, for example, two such grease passages are formed in the brass. The shoulder *k*, and collar *l*, of the journal are confined, as to lateral movement, by the box itself; and a cutter *m*, is passed through the box directly beneath the journal,—the ends of such cutter being flush with the guard-seats, so as to prevent all objectionable play. The patentee remarks, that his improved axles may be made with loose or separate under caps or under covers, if preferred.

He claims, First,—the general arrangement and construction of axle-boxes for railway carriages and waggons, as hereinbefore described. Second,—the system or mode of forming or constructing axle-boxes in one solid piece. Third,—the



system or mode of arranging and constructing axle-boxes with their bearing-springs set or placed directly upon them. Fourth,—the system or mode of constructing axle-boxes with top recesses for holding the bearing-springs. Fifth,—the application and use of buckles or clasps for securing the bearing-springs to the axle-box tops. Sixth,—the upward extension of the bearings of axle-boxes for the conduction of the lubricating matter, as hereinbefore described.

---

*To ADMIRAL THE EARL OF DUNDONALD, of Belgrave-road, for improvements in apparatus for laying pipes in the earth, and in the juncture of such pipes.*—[Sealed 1st June, 1853.]

THIS invention for improvements in apparatus for laying pipes in the earth consists in a carriage having a coulter or cutter for vertically parting the earth, and a horizontal tool attached thereto, similar to that of a drain-plough, whereby an aperture or channel is formed. From the upper and foremost part of the carriage, a duct or opening descends obliquely to the tool (or in any convenient direction), through which duct, drain-pipes or other pipes may be introduced, and continuously deposited in the channel or opening formed by the progressive motion of the apparatus. To facilitate which operation, the pipes are first laid in a line on the surface beneath which it is proposed they shall be deposited: and in order to retain them in a connected range, a rope is passed through them, which is preferred to be elastic, or to have, in one or more parts, an elastic connection, in order that sudden jerks or obstacles shall not occasion injury to fragile pipes.

In Plate VII., fig. 1, shews a section of the apparatus, whereof *a*, is a beam of wood or other material, intended to restrain the movement of the machine in a line parallel to the surface; *b*, is the coulter or cutter; *c*, the tool; and *e*, the duct, through which the range of pipes is continuously to descend and be deposited in the channel or aperture.

The apparatus may resemble the ordinary form of a plough, though the beam seems preferable, by reason of its greater solidity and strength. For the same reason, apparatus differing in dimensions are more suitable than adjustments such as are applied to ordinary ploughs.

Figs. 2, represent these improvements applicable to the juncture of pipes by a concentric knob *k*, (formed on the straight end usual to such pipes), whereby the juncture may

move freely within the cup or circular segment *l*, lubricated by a thin solution of clay, if such pipes are preferred.

The progressive motion of the beam and the action of the coulter may also be facilitated by the said solution, or even by water supplied from a tank on wheels; especially if the surface of the soil is removed in the line of progress by an antecedent plough.

The patentee claims the means herein set forth of continuously depositing pipes in the earth as the apparatus advances.

---

To HENRY WILLIS, of Manchester-street, in the county of Middlesex, organ-builder, for improvements in the construction of organs and free-reed instruments.—[Sealed 14th November, 1853.]

THIS invention relates, firstly, to an improvement on what is known to organ-builders as the pneumatic lever; the object being to improve its action by preventing the lever, after it has overcome the resistance of the pressure of air upon the valves of the organ, from being thrown with force against the check at present provided to receive its impulse. To this end the wind is admitted to the bellows of the pneumatic-lever through a passage governed by a throttle-valve, carried by a rod pendent from the vibrating part of the bellows; and this valve is so adjusted, that when sufficient wind to overcome the resistance of the valves of the organ-pipes has passed into the bellows, the throttle-valve will rise, and close the air-passage. By this means the bellows is supplied with the exact amount of air required to force open the valves of the organ-pipes; and, by cutting off the supply immediately this end is attained, to produce, as a consequence, a noiseless check.

In Plate VIII., fig. 1, represents, in longitudinal sectional elevation, a pneumatic lever fitted with this improvement. *a*, is the wind-chest, from which the air escapes on the depression of the valve *b*, to a chamber *c*, in communication with the bellows *d*. Through the lever or moveable head *d\**, of this bellows, passes a rod or wire *e*, which carries at its lower end a disc-valve *f*, which governs the passage for the air from the chamber *c*, to the bellows. This rod or wire *e*, is tapped to receive at its lower end two leather nuts *g, g*, which embrace the valve *f*, and hold it in any required position on the rod. The top of the rod is bent over to receive the extremity of a strong spring *h*, carried by the lever *d\**, and intended to press down the valve as the bellows falls. The valve is lifted

by the lever  $d^*$ , as it rises, bearing against the under-side of a button  $i$ , on the upper part of the rod  $e$ . Supposing, now, that it is desired to throw the pneumatic lever into action, the player will depress the valve  $b$ , and let in air from the wind-chest to the chamber  $c$ : the air will thence pass to the bellows, and, as the lever  $d^*$ , rises, it will carry with it the throttle-valve  $f$ , which, as it nears its seat, will gradually contract the air-passage and diminish the supply of air. When, therefore, the valve touches the seat, it will do so silently; and the supply of air to the bellows being thus gradually cut off, the lever  $d^*$ , will, after having overcome the resistance of the organ-valves, move silently, and comparatively slowly, to the end of its vibration.

This invention refers, secondly, to an improvement on what is known as the "tremulant," which, by giving off air from the wind-trunk by pulsations, causes all the pipes connected therewith to give out, when speaking, a tremulant sound. The object attained by this part of the invention is to vary the action of the tremulant, by enabling the performer to increase or diminish the intensity of its pulsations, according to the expression which the music requires. For this purpose, instead of the vent for the wind from the wind-trunk to the tremulant bellows being commanded by an inner valve, as in the ordinary construction of tremulant, the vent is left open, and the wind is allowed to press continuously upon the bellows. As a counteraction to this force, springs are provided, which press upon the vibrating part or moveable bed of the bellows, and with an increasing intensity as they are compressed by the expansion of the bellows. The limit of the bellows action is determined by a stop which presses upon the air-escape valve of the bellows, which valve is always held in contact with the stop by the pressure of air on its inner surface. This stop is connected with a pedal placed conveniently for the performer in front of the instrument; and, by means of the pedal, the stop is rendered adjustable.

Figs. 2, and 3, represent one mode of carrying out this part of the invention,—fig. 2, being a longitudinal section of the improved tremulant, and fig. 3, a cross section of the same.  $a$ , is the wind-chest;  $b$ , the bellows; and  $b^*$ , the valve of the bellows.  $c$ , is a frame attached to the wind-chest, and intended to carry the moveable stop  $d$ , for bearing against the valve  $b^*$ , and regulating the action of the tremulant. The stop  $d$ , in this instance, consists of a quick screw; but a cam, or other analogous contrivance, might be employed, to effect the like object. Affixed to the head of the screw is an

arm *e*, which, when the tremulant is required to act, is caused to turn the screw a portion of a revolution, and thereby raise or lower it in its bearing. This motion is transmitted by the performer to the arm *e*, through the agency of a pedal, and an ordinary arrangement of squares and trackers, as will be well understood by organ-builders. *f, f*, are springs interposed between the head of the frame *c*, and the bellows, and intended, as the bellows rise, to offer a gradually increasing resistance to their upward movement, and thereby to counteract the upward pressure of the air, and cause the moveable head of the bellows to vibrate rapidly under the action of the two contending forces. When the tremulant is not required to act, the screw-stop will press on the valve of the bellows, and prevent the bellows from moving. In order to set the tremulant in action, it is only necessary for the performer to raise the stop to a slight degree,—the bellows-valve will then rise, and with it the bellows; but when the bellows has risen sufficiently high to compress the springs which bear upon it, and render that pressure superior to the pressure of the wind, the bellows will be forced down, and air will pass out at the valve. The expansion of the springs will now render the pressure of air in the wind-chest superior to that of the springs, and thus, alternately, the two antagonistic forces will have the mastery, and permit of the escape of the air in pulsations. It will now be understood that this tremulant effect may be heightened or diminished at pleasure, by the performer raising or lowering the screw-stop. The metal vibrator which usually forms part of the tremulant, may, in this case, be dispensed with; or, if used, must be attached to the vibrating part of the bellows.

Instead of removing the valve which cuts off the supply of air from the bellows of the tremulant, it is sometimes found desirable to retain it in organs where the pressure of air in the wind-chest is light, and large quantities of air are used.

The above-described improvement is applicable to seraphines and free-reed instruments generally, whenever the capabilities of the instrument may warrant the introduction of pneumatic levers and tremulants.

The patentee claims, First,—the application to pneumatic levers of a throttle-valve for governing the supply of air to the bellows. And, Secondly,—applying to the valve of the tremulant a moveable stop capable of being actuated by the performer, for the purpose of increasing and diminishing the intensity of the pulsation of the tremulant while the organ is in action.

To JAMES POLE KINGSTON, of *Lewisham-road, in the county of Kent*, for *improvements in combining metals for the bearings and packings of machinery*.—[Sealed 28th January, 1853.]

THIS invention consists in combining tin, copper, and mercury, and using the same as bearings, or linings of bearings, and for packings of machinery. In carrying out this invention, the patentee melts (say) about 9 lbs. of copper, and adds thereto 24 lbs. of tin. This combination he allows to cool, and again melts it, and then adds 108 lbs. of tin; and when the tin is melted, he adds 9 lbs. of mercury, and then allows the whole to cool. The patentee remarks, that he does not confine himself to the precise quantities of the metals above given, but believes them to produce the best compound for the purposes of the invention. The compound metal, thus produced, is to be made into bearings, if for light machinery, by forming it, when remelted, into moulds of the proper forms; and when making packings of machinery, the melted metal is run into the spaces to be packed, as has heretofore been done with other soft metal,—taking care that the surfaces to which the packing is not desired to adhere, are covered with smoke or other proper material, as is well understood. When lining bearings, the surfaces of the boxes or bearings (where the lining is to adhere) are first to be tinned, and the melted metal is then run; cores and moulds being used when necessary, as has heretofore been practised.

The patentee claims the combining mercury with tin and copper in the manufacture of bearings and packings for machinery.

---

To OWEN WILLIAMS, of *Stratford, in the county of Essex*, for *improvements in water-closets*.—[Sealed 2nd February, 1853.]

THIS invention consists in combining fire or heat with a water-closet in such manner that the soil may be burned or dried up, in place of going away with any water used in the closet, as heretofore.

In Plate VII., fig. 1, shews a vertical section of apparatus arranged or combined according to this invention; and fig. 2, shews a transverse vertical section of the same. *a, a*, is a pipe descending from a water-closet, which is only required to be an open-bottomed basin. *b*, is a valve, which is arranged and worked in such manner as to be caused to make a half revo-

lution on its axis after the closet has been used ;  $c^*$ , is another valve, which is ordinarily kept shut when the closet is not being used, but is to be opened by suitable mechanism, as is well understood, either by the weight of the person sitting on the seat of the closet, or otherwise ;  $c$ , is an arm, and  $d$ , a connecting-rod, by which motion is communicated to the axis of the valve  $c^*$ , from the seat or otherwise. From the axis of the valve  $c^*$ , motion is communicated to the axis of the valve  $b$ , by means of the endless chain  $e$ , and chain wheels  $f, f$  ; so that about a quarter of a revolution of the axis of the valve  $c^*$ , will give to the axis of the valve  $b$ , about half a revolution. By this arrangement, the surface of the valve  $b$ , which is upward when the closet is being used, will be downwards when the closet is out of use.  $g$ , is a flue or pipe, leading to a chimney, or otherwise into the open air ; and in order to ensure currents of air up such flue or pipe, a jet of gas is constantly burning at  $h$  ; but if there be a good draught in that direction without the gas jet, it may be dispensed with.  $i$ , is a gas-burner, receiving air for combustion through the apertures  $i^*, i^*$ , which is the source of fire or heat preferred for carrying out this invention,—although other means of obtaining the requisite fire or heat may be resorted to. This gas-burner is supplied with gas by the pipe  $j$ , on which is a cock  $k$ , the plug of which is on the axis of the valve  $c^*$  : hence, when the closet is being used and the valve  $c^*$ , up, the gas-light will be reduced as much as may be, without actually putting it out ; or a small supplementary burner may be constantly lighted near the burner  $i$ , and then the gas may be shut off from the burner  $i$ , when the closet is used, by the act of moving the valve  $c^*$ .  $l$ , is a vessel or boiler, having a chamber  $m$ , with a valve  $n$ , by which any water used to wash out the basin, and also the urine, will flow into the boiler ; and the steam raised by the heat of the burner acting on the boiler will flow off by the pipe  $o$ , into the flue.  $p$ , is a pan, supported near the gas-burner, by which any soil falling into such pan will be dried up or burned, according to the extent of heat employed ; and the heat will also evaporate the fluids in the boiler.  $q$ , and  $r$ , are doors and passages to admit of cleaning out the boiler and pan occasionally ; but the quantity of solid matter in the boiler and the quantity of ash in the pan will be very small indeed. In using this apparatus, the gas-burners or other means of heat will be kept constantly burning, as above explained ; and when the closet is used, the valve  $c^*$ , will be opened, which will bring up the surface of the valve  $b$ , which is ordinarily downwards ; and the soil,

urine, or water, will fall on to that surface of the valve *b*, and, by reason of its inclined position, the fluids will flow into the boiler. When the valve *c\**, is closed, the valve *b*, will revolve half round, and any soil and matters will descend into the pan, or adhere for a time: the great heat of the gas-burner will quickly deprive the soil of moisture, and the same will be quickly dried up and burned.

The patentee claims the arranging the parts of a closet, so that the soil and matters may be dried up or burned by heat suitably applied for that purpose.

---

To CHARLES COATES, of *Sunnyside, near Rawtenstall, in the county of Lancaster, mechanic, for improvements in coupling pipes and other articles, and in apparatus connected therewith.*—[Sealed 1st October, 1853.]

THIS invention consists in placing rings of lead or other suitable metal of an oval, circular, or angular section, between the flanges of pipes or other articles, and in bolting such flanges together so as to compress the metal ring between them; thereby forming an air, steam, or water-tight joint: also in the apparatus for manufacturing such rings of lead or other suitable metal.

In Plate VII., figs. 1, 2, 3, and 4, are transverse sections of different forms of rings, which are preferred to be made of lead, but which may be made of other soft metal. Fig. 5, is a section, through the joint, of two pipes. In this view a ring *a*, similar to that shewn in fig. 1, is supposed to have been placed between the flanges *b*, of the pipes *c*, which are bolted together in the usual manner. The tightening up of the bolts *d*, compresses the ring *a*,—thereby forcing the metal of which the ring is composed into the inequalities in the surface of the flanges of the pipes. It is preferred to have these flanges turned, and to fill up the space between the outer circumference of the joint-ring and the circumference of the flanges with a mixture of paper pulp and size; but in some cases the flanges may be left unturned, and other materials may be used to fill up the space between them. Fig. 6, represents a modification of the invention. In this view a socket-joint is effected by the joint-ring *e*. When the bolts *f*, are tightened up, the nozzle *g*, which has a shoulder on it, forces the ring *e*, against the socket *h*; thereby compressing the joint-ring *e*, and making a secure joint. In this case also the space between the nozzle and socket may be filled up with paper pulp and size. Fig. 7,

represents a section through the mould in which the joint-rings are cast. Each half mould is furnished with five or other suitable number of grooves, the shape of which, when the half moulds are put together, forms oval circles, into which the molten lead or other suitable metal is poured. By this means several rings are cast at the same time, as the metal flows from one groove to the other through the channel *i*. The plates forming the mould are held together by the centre pin *k*, and nut *l*, and they are steadied by the pins *m*. The centre pin is rivetted into one of the plates to facilitate the separating of the plates when the rings have been cast. If it should be required to cast a great many rings at the same time, a series of plates can be secured on one centre pin, and each plate, except the two outermost, must be furnished with grooves on each side.

The patentee claims the improved metal joint-rings, as shewn and described, and the improved apparatus in which such rings are cast.

---

*To CHARLES CALIXTE ANDRÉ GRENIER, merchant, of Castle-street, Holborn, for improvements in the preparation of paints for buildings and other uses.*—[Sealed 25th November, 1853.]

THIS invention consists in preparing paint with gum-lac combined with alkalis and alkaline salts, or any other suitable solvent or menstruum. The different gum resins and other succedanea of gum-lac, such as colophony, sandrach, or mastic, may also be used in a similar or analogous way; that is to say—either with the solvent which the patentee claims for the gum-lac, or with other solvents which permit of being mixed with different colors that are or may be used in painting. Thus by dissolving sub-carbonate of soda, or any carbonate or alkali in water, and by gradually adding lac-resin or gum-lac whilst the whole is on the fire, and being constantly stirred, a solution is obtained which is fit to be mixed with colors and to be used for painting, the same as common color. Also water having been made alkaline by any suitable means, and being mixed with gum-lac, gum-resin, or most other resins or gum-resins, will afford the same advantageous results when used in painting. When the paint, thus obtained, has to be applied on greasy surfaces, or surfaces that have been coated with oil mastic, it will be found useful to add to the color mixed with the above solution, about one-fifth of its volume of linseed oil or other siccativ oil: this addition will not be found to retard



much the drying of the color, whilst it renders it more durable and more waterproof. It is to be understood that the resin-lac may be used in either of the three states in which it is sold or retailed to the trade; viz., in sticks, drops, and flakes or scales.

The same remark holds good with regard to the other resins or gum-resins above mentioned; that is to say—according to the color or shade desired to be produced, they may either be used as they are found in commerce, or else in a purified state, as the colors may require.

The patentee claims using, for painting buildings or other surfaces, a solution of resin-lac, especially that called gum-lac, and other resins dissolved in a variable quantity of water; or by means of a solution of carbonate of soda or other alkali, for the purpose of mixing and fixing the colors.

---

*To EMMANUEL BARTHÉLEMY and TONY PETITJEAN, of Upper John-street, Fitzroy-square, and JEAN PIERRE BOURQUIN, of Newman-street, Oxford-street, for improved means of ornamenting glass.*—[Sealed 25th November, 1853.]

THIS invention has for its object the economical production upon colored glass (through the agency of hydrofluoric acid) of ornamental designs, which will possess the appearance of having been painted by the brush of an artist. The glass to be operated upon may be either of a uniform tint throughout, or may consist of a sheet of white or light-colored glass, covered with a layer of enamel or glass of a darker or different color.

In carrying out this invention the patentees first prepare a pattern or design upon paper, in any given number of tints or shades of the same color, and then provide a corresponding number of stopping-out plates or stencil plates, for covering the glass while the ground for resisting the action of the acid is being laid on; whereby those portions of the glass which are required to be exposed to the acid, are protected from receiving the coating or ground.

These plates are so constructed, that they will severally correspond in form to the touches of shadow made in one of the tints, or to the lights of the pattern required to be reproduced upon the glass; and thus, without employing skilled labor, the glass may be coated with a ground or resist, after each successive biting, at those parts which have been sufficiently reduced by the action of the acid; and the desired touches of light and shade may be thereby obtained.

The manner of constructing these stopping-out or stencil-plates is as follows:—Having prepared a pattern or design after the fashion of patterns for calico printing—that is, with the shadows, demi-tints, and lights combined as they are in designs adapted to the process of printing in colors,—the outline of each shadow, tint, or light, is transferred to the surface of thin sheets of lead or other suitable material; and forms corresponding to the outline of the various tints, and of the lights of the pattern so transferred, are cut therefrom.

The superfluous fragments of each sheet of lead are then removed, without disturbing the other portions of the sheet, and thus counterpart figures of the several tints, and of the lights required to be reproduced in the design, are obtained. To give consistency to these counterpart figures, they are connected to a bed of fine metallic wires, or threads of other suitable material, stretched on a frame and lying in parallel lines at about half or a quarter of an inch apart, more or less, according to the pattern. Or, in lieu of parallel lines of wires, a net-work of fine wire or other material is placed upon the divided portions of the sheet of lead, which, whether isolated or not, are connected to the wires or threads by means of adhesive straps or bands of gummed paper, cloth, or other suitable material. One or more of the sides of the frame it is preferred to make moveable, for the purpose of keeping the wires or net-work in tension, by means of nuts and screws that act upon the moveable side of the frame. It will be understood that each degree of shadow, tint, or light, in the design to be produced on the glass, requires a separate plate; and the number of plates therefore required will depend upon the degree of elaboration of the pattern.

Thin sheets of lead are employed in preference to other substances; because lead being inelastic can easily be made to fit exactly the even or uneven surface of a piece of glass.

The adhesive composition, spread on cloth or paper, and used to connect to the bed of wires or network the fragments of sheet-lead forming portions of the pattern or design, is made as follows:—Equal parts, by weight, or thereabouts, of gutta-percha and spirits of turpentine are mixed together, set on fire, and made to burn until the mixture forms a perfect liquid, of equal consistence throughout, that may be spread, while hot, on cloth or paper. The fabric coated with this material is cut into straps or bands, of any convenient length or dimensions. These are again severed to suit the parts to be connected, and they are placed as bands upon the wires and forms of sheet-lead, and heated by a hot iron passed over

them to melt the adhesive substance, and cause it to attach itself to the wires and the sheet-lead, and bind the two together.

The composition used as a protecting ground or resist to the hydrofluoric acid is made as follows:—From two to five parts of resin are fused by heat, and one part of bees'-wax, according to the temperature of the place in which the work is done: below freezing point, about two parts of resin to one of wax is most convenient for the purpose. At the high temperature of 100° Fahr., or more, about five parts of resin to one of wax would be required. For intermediate degrees of temperature in the surrounding atmosphere, intermediate proportions are required,—the wax remaining always as one to two or more parts of resin. When the resin and the wax are fused together in a mass, the mixture is reduced to a state of fine powder. This powder is dusted over the surface of the glass,—the improved stencil-plate having first been applied thereto; and the powder will cover the portions of the glass left uncovered by the stencil-plate. When this dusting operation is effected, the stencil-plate is removed, and the glass is subjected to a moderate degree of heat, to fuse the powder into a smooth ground that will protect the covered surface from hydrofluoric acid. The degree of heat required to fuse the dusted ground depends upon the proportion of resin in the mixture, but a moderate heat suffices in all cases,—generally about 150° Fahr. The glass is then subjected to the action of the acid, and when sufficiently bitten to produce the tint next in gradation to the full color of the glass, the acid is thrown off. The stencil-plate, corresponding to the second gradation of the tint required, is then applied to the glass, and a second ground laid. Hydrofluoric acid is then applied as before, and a second gradation of tint is produced; and in like manner the other tints are obtained; the lights, when such are to be given to the design, being obtained last by the biting of the acid down to the clear glass. It will be understood that by superimposing one color on another, by the fusing of two pieces of colored glass together, and also by tinting the glass on opposite sides with different colors, a variety of effects may be produced in connection with the use of this invention.

The patentees claim producing ornamental designs or patterns upon colored glass by the use of stencil-plates, as above described.

---

To CHARLES DE BERGUE, of Dowgate-hill, in the city of London, engineer, for an improvement or improvements in machinery or apparatus for removing patterns from moulds for castings.—[Sealed 14th November, 1853.]

THESE improvements consist of a table, machine, or apparatus so constructed as to draw the pattern or patterns, or separate the pattern or patterns from the mould, by means of rods, bars, or slings, or other equivalent, applied at each of two or more separate points or parts; such rods, bars, or slings, being each guided so as to work or move in a direction perpendicular to the surface of the sand or other material used in the mould, and so as to effect the draw or separation of all parts of the pattern or patterns steadily and gradually, and also simultaneously, and to an uniformly equal extent out of or away from the surface or surfaces of the mould with which the face or faces of the pattern or patterns are in contact.

In Plate VII., fig. 1, is an elevation of an improved moulding table, together with the apparatus for lifting the patterns; fig. 2, is a horizontal section, at  $z, z$ , of the table only; fig. 3, is a plan of the top, shewing a moulding-box, a wheel-pattern, and the apparatus for raising the latter; and fig. 4, is a section through the moulding-box at  $y, y$ , and through the table at  $x, x$ . The table (besides its framing) mainly consists of four lifting rods or pillars (for carrying the apparatus to which the pattern is to be attached), and of a combination of wheels and pinions for giving a perfectly parallel, simultaneous, and uniformly equal vertical motion to the rods or pillars. The framing of the table is composed principally of the four frames or plates  $a, a$ , and  $b, b$ , (which are bolted firmly together) a wooden cover on the top, lined with sheet iron, to prevent untimely wear, and a wooden bottom.

The frames  $a, a$ , contain recesses to receive the lifting-rods  $c, c$ , which recesses are bored perfectly vertical and parallel to each other at  $a^*, a^*$ ; and caps  $a^2, a^2$ , are screwed to the frames at these places, to form perfectly steady slides for the said rods.  $d$ , is a small fly-wheel, with winch-handle upon it, for turning the shaft  $e$ ; and  $f$ , is a ratchet-wheel, fitted with a pawle, for preventing the return or recoil of the motion given to it.  $g$ , is a pinion on the shaft  $e$ , which takes into the spur-wheel  $h^*$ , and thus turns the shaft  $h$ , and the pinion  $h^2$ , which is also fast upon it. This second pinion takes into the spur-wheel  $k^*$ , and thus turns the shaft  $k$ , and also the two pinions  $k^2, k^2$ , which are also fast upon it. These last pinions take into the pair of spur-wheels  $j, j$ , on the same shaft  $i$ ; and

these wheels gear with the pair of wheels  $j^*, j^*$ , on the same shaft  $i^*$ . Each of the four wheels  $j, j$ , and  $j^*, j^*$ , is furnished with a link or connecting rod  $l$ ; and the four links  $l$ , thus give the same amount of vertical motion uniformly and simultaneously to four lifting-rods  $c, c$ , respectively.

The apparatus to which the pattern or patterns are to be attached may be of various constructions. Two different ways are shewn in the drawings. In both, however, the lifting rods terminate in a flat part  $c^*, c^*$ , to which the partial rim or parallel bars  $m, m$ , are screwed or rivetted. In figs. 1, 3, and 4, three-legged bearers  $n, n$ , are shewn, resting on the said bars at 1, 2, 3. The bearers contain a number of slots, as shewn at  $o, o$ , (fig. 4,) for the purpose of fixing to or upon them a sufficient number of universal brackets  $q, q$ , by means of screws and bolts.  $p, p$ , are screwed pins, with flat slotted heads for fixing them to the brackets  $q, q$ , by adjustable screws; which pins are used for screwing into the pattern when it is required to be raised.  $s$ , represents the pattern of a wheel, and  $t$ , the box in which it is required to be moulded. The apparatus, partially shewn in figs. 5 and 6, consists of two or more cross bars  $w, w$ , which rest on the rim or parallel horizontal bars  $m, m$ . These act upon a plate  $v$ , of wood, or of any suitable material to which the pattern is permanently fixed, in such a manner that the former extends over the moulding-box far enough to be reached by the cross-bars  $w, w$ . The plate  $v$ , has holes to receive the pins  $4, 4$ , of the moulding-box, in order to secure the position of the pattern. The manner of using the table and apparatus is as follows:— For the better accommodation of the moulders, the top of the table may project, as shewn at 5, in figs. 1 and 5. If the apparatus, shewn at figs. 1, 2, 3, and 4, be used, the pattern is laid upon this projecting part, and the moulding-box is put on the top of it, and rammed up in the common way. This being done, it is turned over into the centre part of the table; the pattern then becoming the uppermost. Next, the three-legged bearers  $n$ , are put upon the parallel bars  $m, m$ , in convenient number and distances; and the slotted pins  $p, p, p$ , being screwed into the pattern, and being properly adjusted and fixed to the bearers by means of the universal brackets  $q, q, q$ , it is drawn out steadily and vertically, by turning the shaft  $e$ , by means of the handle  $d$ , as described before,—the ratchet and pawle preventing its return. The pattern and three-legged bearers are then to be removed; and the box having been taken away, the four lifting-rods and the horizontal parallel bars supported by them, may be lowered again,

by simply raising the pawle. When the apparatus shewn at figs. 5 and 6, is applied, the pattern attached to the plate *v*, being uppermost, the cross-bars *w, w*, are laid on the parallel bars *m, m*, and underneath the projecting ends of the plate *v*, so as to raise this by turning the handle *d*, in the manner above described. In the beginning of the lifting, a hammer may be used for both plans, to start the sand.

The patentee remarks, that the number of lifting-rods may be varied; and four of them, or any other suitable number, may be simultaneously raised, and the same effect produced by other mechanical means than those above described and represented,—such as levers or cams, or racks and pinions, or screws,—but the means specified are preferred; the working parts being less liable to be injured by sand and dirt. He also remarks, that guided slings may be substituted in place of the lifting-rods described; suitable mechanical arrangements being made for moving them simultaneously, and to an uniform extent. Instead of the pattern or patterns being lifted out of, or removed away from the mould, the table-machine or apparatus may be modified so as to hold the pattern or patterns steady; and the bed or surface of the table, with the moulding-box upon it, may be made to drop, or be moved away from the pattern or patterns, or a motion may be given to both of them in the act of separating from each other. Provided always that suitable arrangements be made for the required guiding of its working parts.

---

*To GEORGE FERGUSON WILSON, of Belmont, Vauxhall, for improvements in the manufacture of cloths, and in the preparation of wool.*—[Sealed 1st April, 1853.]

THE patentee states, that he prepares the oily matters that result from the destructive distillation of rosin by distillation, or repeated distillation, with the air excluded; or he previously subjects the rosin oily matters to the action of powerful agents; such as sulphuric acid; or exposes them to heat, to drive off their more volatile part: he then applies them, either alone or mixed with oleic acid or neutral oils, in the preparation of wool, and in the manufacture of woollen and other cloths, in place of the oils now in use for like purposes.

Having thus stated the nature of his invention, he proceeds to describe the manner in which the same is to be performed.

In the manufacture of woollen and other cloth, and also in the preparation of wool, oils are used. Now this invention

consists in applying rosin oil in substitution, or in part substitution, of the oils heretofore employed for such purposes. It is preferred to use distilled rosin oil, prepared as described in the specification of a patent granted to Mr. Gwynne, in conjunction with the present patentee, 16th November, 1843;\* and such rosin oil may be employed alone or mixed with other oils, either in the acid or neutral state. It is preferred, however, to combine distilled rosin oil with oleic acid, and to mix them in equal quantities. The rosin oil, or the combined oils, are to be used in like manner to that of other oils heretofore employed.

This invention consists, as above explained, in the application of rosin oil to such purposes, by which the processes, where oil is used when treating wool and woollen cloths, are cheapened and improved.

---

*To GEORGE FERGUSON WILSON, of Belmont, Vauxhall, for improvements in treating wool and fabrics composed of wool.—[Sealed 10th October, 1853.]*

It is well known, in processes of treating wool in the manufacture of fabrics composed of or containing wool, that oils are used, and various oils have before been employed in these processes. Now this invention consists in applying, in such processes, a combination of castor oil with oleic acid, or with the oleine of palm oil; such combined oils being employed in like manner to that of olive and other oils, when used in such processes.

In carrying out his invention, the patentee combines the oil at the rate of ten per cent. of castor oil to ninety per cent. of oleic acid, or of the oleine of palm oil; and in order to blend these matters well and intimately together, he prefers to boil them up by means of free steam for about half-an-hour. This compound oil, when cold and allowed to settle, is used in the manner in which olive and other oils have heretofore been employed in treating wool, and which is well understood. The patentee remarks, that he does not confine himself to the precise proportions stated.

He claims the combining castor oil with oleic acid, or with oleine of palm oil, and using them in the preparation and treatment of wool and fabrics composed of wool.

---

\* For specification of this patent see Vol. xxviii, p. 99.

To WILLIAM KING WESTLY, of *Leeds, flax machinist, for an improved comb or gill for heckling, drawing, roving, and otherwise preparing to be spun, hemp, flax, tow, silk, wool, and other fibrous substances.*—[Sealed 18th March, 1853.]

THIS invention relates to the arrangement and construction of an improved gill-combing apparatus, for the treatment of fibrous substances, in which apparatus both sides of the fallers are furnished with combs, each individual comb on each faller acting alternately upon the material to be treated. The fallers are traversed forward by spiral traversers or screws, in the ordinary manner; but as they each arrive at the end of their forward traverse they are successively disengaged from their conducting spirals by the descent of a tooth projecting from the interior of a revolving ring or annular toothed wheel; one such ring being fitted at each end of the line of fallers, just inside the spirals. As the various fallers are in this way successively thrown out of connection with their traversers, they are severally carried back for a new action, by the onward progress of the tooth hereinbefore mentioned, along a semi-circular guide beneath the spirals; when they are again engaged with the fibrous stream and with the spirals. In order to prevent the fallers from being carried entirely round with the revolving rings, a small fixed incline is made to project slightly inside each ring; so that, as the fallers are brought against the incline, they are each pushed off the actuating tooth, and left free to be carried in a direct line upon their guide-rails by the spiral traversers. The number of internal teeth in the revolving rings or wheels must obviously be regulated to suit the pitch and speed of the spirals; so that each faller, as it arrives at the end of its traverse, may be duly removed by its allotted tooth. It is thus obvious that the course of the fallers is that of a direct straight line and a semicircle combined; and that the comb which is in action during one traverse along the spirals, goes out of action during the next traverse, and so on throughout the action.

In Plate VIII., fig. 1, is a longitudinal vertical section of the improved drawing-frame; and fig. 2, is a corresponding plan of the same. Fig. 3, is a side elevation of one of the fallers or comb-bars detached; and fig. 4, is an end view of the faller alone. In figs. 1, and 2, the drawing and pressing-rollers are shewn at *a, b*,—*c, c*, are the detaining rollers. The spiral traversers or screws *d*, which actuate the gill-combs *e*, work in end bearings in the side standards of the framing;



being actuated by the two pairs of bevil-wheels  $f, f$ , from the cross-shaft  $g$ . This cross-shaft  $g$ , is driven by the train of spur-gearing  $h$ , from the front drawing-roller spindle  $i$ , the opposite end of which spindle carries the fast and loose driving-pulleys  $j$ , whence the whole of the movements are derived. The duplex arrangement of the comb-bars or fallers  $e$ , is clearly delineated in figs. 1, and 3. One line of comb-teeth  $k$ , being on each side of each bar, and each bar being reversed on every traverse, it follows that the combs act alternately in carrying forward the treated material. The revolving rings  $l$ , are, in this instance, modifications of "mangle-wheels," as commonly used in textile machinery; each wheel having internal projections or teeth  $m$ , upon it, for acting, at stated periods, upon the fallers. They are supported and retained in position by the rollers or antifriction pulleys  $n, n^1$ , and  $o$ . These details are precisely the same on each side of the machine. In order to give motion to the ring or mangle-wheels, the spur pinion  $p$ , in each case, is keyed fast upon its transverse shaft  $q$ , which shaft is actuated, at the required rate, by means of the wheels  $r$ , from the spur train. The spur pinion on  $q$ , has, on each side of it, an antifriction pulley  $n$ , loose on the shaft,—the two pulleys, in each arrangement, being set to embrace the pinion closely, although loose on the shafts. These pulleys rotate with the shafts, but at a slightly different velocity, as the diameters of the pulleys are slightly different from the pitch-line diameter of their pinion. Within each of the rings or mangle-wheels is fitted a semi-circular guide-plate  $s$ ; and the horizontal upper edges  $t$ , of these plates, serve as supports for the gills during their forward traverse, when in real work. At  $u$ , are fixed inclined stops for entering the gills into the threads of the screws, as the gills commence their forward traverse. In order to exhibit the screws clearly, several of the gills are removed in fig. 1. The action of the machine is this:—The gills are carried along the upper edges  $t$ , of the guide-plates, in the direction of the arrows, by the spiral traversers or screws  $d$ ; but, as each successive gill arrives at the termination of its traverse along the upper edges of the guide-plates, it is carried down out of the screw-threads by the descent of one (on each side) of the projections or teeth  $m$ , in the revolving rings. The gill is then directed into and carried along between the lower curved or semi-circular edges of the guide-plates, as at  $v$ , and the interior surfaces of the mangle-wheels. When the gill arrives at the beginning of the screws again—that is, at the back of the machine—it is disconnected from the projections  $m$ , by

coming in contact with the fixed inclined stops *u*, which now force the gill off the acting edges of the teeth, and place it in a position to be carried along by the screws, as before described. The spiral traversers may either be single or multi-threaded screws.

The patentee claims, first,—the general arrangement of machinery or apparatus, as hereinbefore described, for drawing and heckling fibrous materials. Second,—the application and use of the revolving rings, in conjunction with the semi-circular guide-plates, in the manner and for the purpose hereinbefore described. Third,—the system or mode of constructing duplex gills or fallers, or gills with two combs, one on each edge or surface, as hereinbefore described. Fourth,—the system or mode of combing or heckling fibrous materials, wherein duplex combs or gills are alternately traversed forward in action, and returned out of action along a curved guide in the direct line or continuation of the forward guide, whereby the gill is reversed at each movement.

---

*To CHARLES GOODYEAR, of Avenue-road, St. John's Wood, for improvements in spreading or applying India-rubber, or compositions of India-rubber, on fabrics.*—[Sealed 15th July, 1853.]

It is well known that heretofore when spreading india-rubber on to fabrics, it was done by using a solution of india-rubber which was very fluid; but the more general mode practised of late years has been to mix only a certain quantity of solvent with the india-rubber, so as to permit of the spreading being accomplished with facility, by moving the fabric under a straight-edge or gauge. It has also been proposed, first to roll out a sheet of india-rubber, and to cause it to apply itself to the surface of a fabric by pressure between rollers. Each of these methods, when applied to thick and coarse fabrics, causes the weight of india-rubber necessary to fill up the inequality of such fabrics to be very considerable, and renders the application of india-rubber to coarse fabrics too costly for the uses to which such fabrics are applied. Now the object of this invention is so to apply a coating or surface of india-rubber to a coarse fabric (such as canvas) that the interstices and irregular surfaces shall not be filled up, but have a thin film or sheet of india-rubber, or india-rubber compound, adhering only to the more elevated points of the surface; by which a comparatively small quantity of india-rubber will be

required to obtain a complete water-proof surface to a coarse fabric. The improvements in the process of manufacture consist in so acting on the surface of the fabric to be coated with india-rubber, that, in the first place, only the more prominent or elevated points of the surface shall have india-rubber applied thereto, and then, by applying a sheet of very thin india-rubber, or a compound thereof, by pressure, the same will adhere at those parts of the surface where the india-rubber has been previously applied. For this purpose two heated rollers are employed; the surface of the upper one moving somewhat faster than the other. The under roller is coated with felt, or vulcanized india-rubber, to offer an elastic bed or surface to the fabric which is being partially coated. The coarse fabric to be coated is conducted between these rollers, and is moved away by any convenient means. As fast as the rollers, by their rotation, pass the fabric between them, a quantity of kneaded india-rubber from the kneading-machine is placed on the surface of the fabric, and in the angle between the rollers; and by reason of the faster surface speed of the upper roller, the india-rubber will be caused to apply itself only at the more elevated parts of the surface of the fabric, and those parts will be slightly coated with india-rubber; whilst the indented or more hollow parts of the surface of the fabric will be uncoated and not filled up. The fabric, thus treated, is then to have a complete covering surface of india-rubber, or india-rubber compound applied thereto. For this purpose a very thin sheet of india-rubber, or india-rubber compound, is rolled out between two warmed rollers; but it is preferred to employ a very thin sheet of india-rubber fabric, made, as has heretofore been practised, by cementing a fleece of cotton into a fabric; and in order to cause the thin sheet of india-rubber, or india-rubber compound, or fabric, to adhere to the coarse prepared fabric, they are pressed together between heated rollers (which have an equal surface speed), by which the points of the surface of the coarse fabric which are coated with india-rubber, will be caused to adhere to the sheet india-rubber, or sheet of its compounds, and thus produce a regular and water-proof surface; the quantity of india-rubber being small compared with what would ordinarily be used, where the irregular and undulating surfaces of coarse fabrics are filled up with india-rubber or india-rubber compounds.

The patentee claims the mode herein described of manufacturing water-proof fabrics, where coarse surfaces are to be coated with india-rubber or india-rubber compounds.

---

To THOMAS RICHARDSON, of Newcastle-upon-Tyne, chemist, for improvements in the manufacture of certain compounds containing phosphoric acid.—[Sealed 16th May, 1853.]

THIS invention consists in mixing muriate of soda or potash with an earthy or metallic phosphate, and about their equivalent quantity of sulphuric acid, and, by preference, in a reverberatory furnace, such as is used in decomposing common salt; or, in place of muriate of soda or potash, sulphate may be used with less sulphuric acid; or bisulphate may be employed. Or, when phosphate of soda or potash is desired, this is obtained by decomposing muriate, or sulphate, or nitrate of the alkali by phosphoric acid,—employing iron, or brick, or earthenware vessels or furnaces; and the muriatic, sulphuric, or nitric acids evolved, are collected. Phosphates may also be dissolved by waste muriatic acid of chemical works, and precipitated by lime or magnesia.

The means pursued by the patentee are thus described:—To manufacture a compound of phosphoric acid and sulphuric acid with lime and soda or potash, for manure and other purposes, take apatite, coprolites, bone-ashes, or any other substance containing phosphoric acid, as free from organic matter as possible, and reduce the same to powder. Ascertain, by analysis, the quantity of phosphoric acid in the powder, and mix 76 parts of muriate of potash, or 60 parts of muriate of soda, with every 72 parts of phosphoric acid. This mixture is thrown into an ordinary reverberatory furnace; but it is preferred to use the pan-furnace employed in alkali works for decomposing common salt by sulphuric acid. As much sulphuric acid is then run upon this mixture as will decompose the muriate of potash or soda, and combine with the whole of the basic constituents present in the phosphate, so as to set the phosphoric acid at liberty. This operation is continued until all acid fumes are evolved; and the mass is dried, at a moderate heat, on one of the side furnaces,—in which state it is ready for use as a manure. Or the sulphates of the alkalies are substituted, and a smaller quantity of sulphuric acid, corresponding to that present in the alkaline sulphate, is employed. Or bisulphate of the alkalies is used, and only so much sulphuric acid as may be necessary to decompose any carbonate, or other body present, which would consume a portion of this acid.

To manufacture a phosphate of soda or potash, a solution of phosphoric acid is prepared by any of the usual methods, and run upon muriate or sulphate of soda or potash in a

reverberatory furnace, in such proportions that there shall be rather more than one equivalent of phosphoric acid for one equivalent of any of the above salts. The process is conducted in the same way and with the same precautions as are employed in making sulphate of soda. When the operation is conducted in what is termed a close furnace, the muriatic or sulphuric acid may be collected by any of the methods now in use for that purpose. When treating nitrate of soda or potash, the apparatus at present in use in making nitric acid is employed,—substituting an equivalent of phosphoric acid for the sulphuric acid necessary for decomposing these nitrates: or phosphoric is substituted for sulphuric acid in the manufacture of the latter acid, in decomposing the nitrates of the alkalies in the ordinary iron pots. Phosphate of soda or potash is also made by employing phosphoric acid in place of sulphuric acid, in those cases where the muriates of the alkalies are used for the manufacture of muriatic acid in iron retorts or cylinders.

To obtain a purified phosphate of lime or magnesia, take any phosphate containing too much organic matter or other impurities for use in the preparation of the preceding compounds, and treat it with as little muriatic acid as possible, for the purpose of dissolving out the phosphate. The liquor, separated from the insoluble organic or inorganic matters, is now treated with as much lime or magnesia as is found necessary (by a few preliminary trials) to precipitate the phosphate, which is collected, washed with water, and may now be employed in any of the above processes.

The phosphate of soda or potash produced by any of the above processes, is the monophosphate of these alkalies. If the salt is mixed with any impurities it must be dissolved in water, and allowed to stand until they subside. After concentrating the liquor, the salt crystallizes in the usual way, which may be employed as a manure, or in the manufacture of glass and porcelain, in lieu of the ordinary phosphate of soda, with two atoms of fixed base.

The patentee claims, First,—the manufacturing a compound of phosphoric and sulphuric acids with lime and soda or potash, by the mode herein described. Second,—the decomposing alkaline salts by phosphoric acid, in a reverberatory furnace, or in apparatus suitably arranged for retaining the acid liberated from the salts during such decomposition. Third,—the obtaining a purified phosphate of lime or magnesia from an impure phosphate, by the process herein described.

To EDMUND LEYLAND, of *Saint Helen's, in the county of Lancaster, builder, for improvements in apparatus for the manufacture of sulphuric acid.*—[Sealed 10th September, 1853.]

THIS invention consists in the construction and application of chambers or vessels of brick, instead of similar erections of lead, in the manufacture of sulphuric acid or the vitriol of commerce. The bricks employed for this purpose are moulded of any convenient shape or dimensions, and they are composed of such materials as will effectually resist the action of the acids and gases which are incidental to the manufacture of sulphuric acid. The materials preferred are similar to those employed in the manufacture of glazed stoneware pipes. It is also found advantageous so to burn such bricks, and so to form them, either as hollow, or perforated, or cellular masses, that they shall be thoroughly vitrified; and, provided the shape is not materially injured, the vitrifying process cannot be carried too far, as thorough vitrification is essentially necessary. If glass bricks, of good form, and possessing the necessary resisting powers, could be economically obtained, they would be preferred; but any bricks, of whatever mineral substances they may be composed, whether vitrified or not, are suitable and applicable to the improved sulphuric acid apparatus, in proportion to their power of resistance hereinbefore referred to, and their fitness as building materials.

In building up such vitrified materials into sulphuric acid chambers, the necessary junctions are effected by the aid of any suitable and convenient materials or cement, possessing the same resisting property as the bricks themselves. It is preferred to construct the chambers of a conical shape, nearly resembling the form of circular pottery ovens; that is to say, with a circular plan, and with a curve, slightly within a catenary curve in mid-sectional elevation,—making the height equal to about one and a half times the greatest diameter. Such erections are fairly equilibrated, and require little or no staying or binding; but where it is necessary to stay such chambers, iron stays or binders, with a leaden covering over them, are used. A leaden bottom is applied to such chambers,—the lead being carried under the walls, and rising up outside, so that the walls will virtually stand in a large leaden cup: any liquid therefore coming down the inside wall surfaces, or down the body of the walls, may be all caught by this bottom cup. Outside the chamber, and round the bottom thereof, is placed a projection, somewhat higher

than the turned-up edge of the leaden bottom, with gutters formed under such projection to convey the rain, falling upon the building, clear away from the leaden cup.

To prevent the weight of the walls from squeezing out the leaden bottom on which they rest, very wide footings are set upon the lead, so as to distribute the weight over a superior surface. The leaden bottom may be dispensed with, if very good bricks and cement are used. The gases and vapours are admitted and withdrawn at suitable places, as must be obvious to the practical man; and the chambers are connected with each other, and with any other apparatus, by pipes or ducts of brick, stoneware, or lead. Provision is made, at the bottom of these chambers, for the withdrawal of the sulphuric acid; and lutes or other openings, or whatever other adjuncts may be necessary, must be made of lead or stoneware.

Bricks, of various kinds, have heretofore been used in and about many minor parts and adjuncts of sulphuric acid chambers; and it has also been proposed to employ chambers of bricks or of iron to collect and condense any volatile metallic oxides or other compounds, or dust from the burning gases before their admission into the sulphuric acid chambers. The patentee remarks, that he does not claim the use of bricks, or similar materials, for such minor purposes.

He claims, First,—the general system of arrangement and construction of apparatus, for the manufacture of sulphuric acid, as hereinbefore described. Second,—the application and use of brick chambers for the formation and condensation or the actual manufacture of sulphuric acid.

*To WILLIAM LOUIS SHEBINGHAM, of Southsea, in the county of Hants, Captain in Her Majesty's Royal Navy, for illuminating buoys and beacons in harbours, roadsteads, and rivers.— [Sealed 6th January 1853.]*

This invention consists in illuminating buoys and beacons by means of the combustion of gas, volatile spirits, or any other suitable hydrocarbon, in a lamp or lantern attached to the buoy, and daily ignited by the aid of an electric current. The required illumination may also be effected by means of the electric light. The method by which it is proposed to illuminate beacons or buoys with the aid of gas, is, by conveying to the lamp contained in a lantern attached to a beacon or buoy, a stream of common gas, under water along the ground, in a

tube made of jointed metal, or of some flexible impermeable material, such as gutta-percha or India-rubber. In a similar manner insulated electric conducting wires are laid down, by means of which currents of electricity are transmitted to the lanthorn or lamp, either from a galvanic battery or any other machine for producing electric currents. One or more of such wires may be made to pass through the tube for conveying the gas; but it is generally better to lay down the wires outside the gas tube, so as to prevent the gas from corroding or destroying the wires or the insulating material by which they may be covered. The extremities of these wires within the lanthorns affixed to the beacon or buoy, are made of platinum or some other metal not easily oxydized; and the insulated wires are conveyed through the lanthorn to the burner; the platinum points or lips being placed in such positions that a stream of electricity may pass from one point to the other through the gas when it is flowing out of the burner, and thus ignite the gas. Two conducting wires are necessary for producing the current of electricity; but if one of the wires be made continuous between that battery and the burner, the ground or water may be substituted for a portion of the other wire, so as to complete the circuit in the well-known manner. The apparatus being thus constructed, and the gas turned on by opening a cock in the supply-pipe on shore, a stream of electricity will cause the gas escaping from the burner to ignite, and the combustion will continue as long as the supply of gas is kept up; and when the light ceases to be wanted, it may be extinguished by shutting a cock in the pipe by which the gas is supplied. The mode by which light beacons and buoys are illuminated by the combustion of naphtha or other hydrocarbon is as follows:—If the material to be used be mineral naphtha, volatile spirit, or other similar hydrocarbon, a suitable lamp is placed in the lanthorn upon the beacon or buoy, to which, insulated electric wires are conducted in like manner as above mentioned; their extremities being made of platinum wire, as before. The lamp is made with a reservoir sufficiently large to contain a sufficient quantity of the material for many weeks' consumption, and it is also made with a reservoir for a vegetable naphtha to supply a saucer or cup attached to the lamp in which the naphtha is to be ignited for the purpose of lighting the lamp. This saucer or cup is filled at each time of lighting the lamp, and the supply is regulated by a suitable valve put into motion by an electro-magnet which is made magnetic, and thus gives motion to a keeper by means of a current of electricity transmitted through



the conducting wires from the shore,—the supply being regulated so as to produce the heat necessary for lighting the burner. Another electro-magnet is also fitted within the lanthorn, so as to act in the same way upon an extinguisher; by which, when a current of electricity, passing along the proper conducting wires from the battery on the shore, brings the magnet and the extinguisher connected with it into action, the light will be extinguished; after which, when the magnet ceases to act, the extinguisher will return to its place, clear of the burner. The naphtha in the saucer is to be ignited by the action of a current of electricity passing through it, in like manner as above described with respect to the gas. Three electric circuits are requisite for this mode of lighting; and, for this purpose, the necessary number of insulated electric conducting wires is laid down in manner above mentioned. For the purpose of carrying out this mode of lighting it is preferred to use the patent naphtha lamp, known as Messrs. R. Holliday and Company's lamp; but any other suitable lamp may be employed.

The lamp can be supplied with a sufficient quantity of atmospheric air by means of a syphon tube, from the lower part of the interior of the lamp, passing through the top and curving over the external part of the lamp. Trap-valves may be employed, which shut by the pressure of the water. The ventilation may be effected by a similar syphon tube from the top of the lamp, or by any other suitable means.

---

*To* ROBERT JAMIESON SIBBALD, of *Paddington, Edge-hill, West Derby, in the county of Lancaster, surgeon, for an improved mode of communicating from vessels to the shore, or from one vessel to another.*—[Scaled 21st Nov., 1853.]

THIS invention consists in using, as a float or buoy, an inflated bag or balloon, made of any water or air-proof materials, to which is attached a cord, which cord is wound round the float, or upon a reel attached thereto, or placed upon or within the float, so that the coil of cord is carried by the float in such a way that when the apparatus is cast into the sea, and one end of the coil is held on board the vessel, it will unwind, or "pay out," as the float is blown to leeward by the wind. By this arrangement the float has not to drag the rope after it in its progress, but merely to uncoil it.

It is preferred to give the floats a spherical or oval shape, and to construct them of India-rubber, gutta-percha, or other

flexible air-proof substance,—keeping them distended in one direction by means of ribs or rings; so that, when not inflated, they will lie flat, and be portable. And that they may be readily inflated, a hollow staff or standard is used, which is passed through a valve placed at one end of the bag and into a socket fixed on the inner side of the reverse end; so that, when the apparatus is required to be inflated, all that is requisite is to force out the bag by means of the staff until it is fully distended, and then to close the valve. Pockets, or small depôts, are constructed in or upon the floats, into which letters or other small articles can be placed and conveyed therein.

The figure in Plate VIII., represents an oval-shaped hollow float *a*; *b*, is a long cord wound round the float; *c*, a wooden socket at the pole of the float, into which the hollow staff or standard is fixed; *d*, a valve through which the hollow staff is introduced into the interior of the float; and *e*, a small pocket formed on the outside of the float, for the reception of letters or other small articles. The internal frame-work of the float is shewn by the dotted lines, which indicate the position of six circular hoops or ribs. *f*, is the hollow pole or staff, extended through the centre of the float from *c*, to *d*. By the use of apparatus constructed as hereinbefore described, it will be seen that a rope and letters, or other small articles, can be readily sent from a vessel to a lee shore, or from a vessel to windward to one to leeward, without danger or inconvenience, by merely casting the apparatus overboard, and keeping hold of the end of the cord attached thereto. It is found by experience that, with a very light wind, a spherically-shaped float of only two feet diameter, will readily carry out a stout cord 2000 feet long. Should the cord attached to one float not be found of sufficient length, a second float is attached near the end thereof, in such a way that the second float can revolve upon its axis, to allow the rope attached to it to uncoil itself as it is drifted to leeward; one end of the cord being held on board, in the same way as the cord of the first float hereinbefore described.

The patentee claims the apparatus hereinbefore described (or any mere modification thereof), and the use of the same, as a mode of communicating from vessels to the shore, or from one vessel to another substantially and in the manner hereinbefore described.

---

To WILLIAM PIDDING, of the Strand, Gent., for improvements in the treatment of oleaginous, fatty, or gelatinous substances, for purifying, decolorizing, compounding, or clarifying the same.—[Sealed 12th February, 1853.]

“MY invention” (says the patentee) “consists in improvements in the making of soaps, and the treatment of oils and fatty bodies, with a view to the bleaching, clarifying, and refining thereof. My improved mode of making soap consists in first distilling the oils or fats so as to convert them into the ‘fat acids,’ as they are termed, and then subjecting them to the action of a carbonated alkali, and subsequently adding a sufficient quantity of caustic alkali to fit them for use. My improvements in the bleaching, clarifying, and refining of oils or fatty bodies, consist in allowing them to percolate through filters containing pure alumina (that is, hydrate of alumina), or hydrates commixed with any substance which renders the alumina or mixture somewhat adhesive, and less dense than it would be if used alone. To effect this object, gums finely pulverized, but not soluble in fatty bodies, copal and sandarach (usually called gums), in a similar state, or gutta-percha rendered in a fluid state by heat. Fatty bodies which are solid at the ordinary temperatures, must, of course, be kept liquid by heat during the operation. I also manufacture by this my invention what are termed ‘fancy soaps.’ I form ‘mosaic’ soap by putting angular slips or pieces of any size, or length, or form, together, so as to produce variegated patterns, regular or irregular, and of various colors, and shapes of colors. The conglomerates are then heated sufficiently only to produce adhesion of the surfaces in contact, and form a solid compound block of soap. In forming patterns of irregular kind, I obtain by placing variously colored and shaped pieces of soap together, and, by means of heat, I force the mass into portions, packets, or cakes, for cutting into any definite size or shape. I coat the above cakes with a transparent varnish, or gelatine, or collodium, to give them a slightly glazed surface; improving their appearance and preserving the perfumes, when such are therein incorporated. I boil or melt fat acids with carbonated alkali instead of employing the ordinary methods of making soap,—using a small quantity of caustic alkali, to fit it for use. My mode of forming such fat acids is to boil the fat and oily bodies in contact with metallic oxides and water,—using about four pounds of any cheap metallic oxide to 1 cwt. of the fat or oil. I keep up the boiling until a perfect combination is effected;—the fat acids are con-

sequently formed. The completeness of the combination of the ingredients may be easily ascertained by feeling the compound, as it leaves it dry and brittle, instead of being greasy. I then pour in as much diluted and cheap acid (as sulphuric) as will completely decompose the metallic soap,—the boiling being kept up until the whole fat or oil is separated. The oxides may be again separated from the acids, to be available for the repetition of the operations above mentioned, by any cheap earthy alkaline substances. The fats or oils may be boiled with lime in the usual way for the manufacture of candles, and converted with the fat acids in combination with lime; these may be separated in the ordinary manner—viz., by sulphuric or other cheap acid. When separation takes place between the fat acids and the substances employed in the operation, I stop the boiling—allowing the materials to stand until the fat acids, so formed, float, when they are to be pumped, or drawn off, and submitted to the action of the carbonated alkali; and then the soap is to be finished or fitted for use by means of caustic alkali.”

---

*To WILLIAM NAIRNE, of South Inch Mill, Perth, flax-spinner, for improvements in dressing yarns for looms.—*  
[Sealed 24th January, 1853.]

THESE improvements in machinery for dressing yarns for looms consist in an apparatus which supplies the yarn with dressing without the necessity of diluting the dressing with water, which impairs its adhesive and fibre-laying properties, soaks the yarn in flour and water, making it difficult to dry, and stiff and brittle when it is dry, while its fibres are not so well laid as when coated with dressing undiluted.

The machinery by which this is performed consists of a box, in which a roller revolves slowly: to this roller is applied a straight-edge or doctor (as a similar instrument used in cylinder printing is called), so placed in the box that it can be set nearer or farther from the roller; and partly upon the distance of this straight-edge from the roller, as well as upon the speed of the roller, the quantity of dressing put upon a given length of warp depends. In the box containing the roller is a false or moveable side, which gathers the dressing in towards the roller; so that most of the dressing in the box may be used up before it is necessary to add more; for it must be kept in mind, that, with this improvement, the dressing may be used so thick that, unless it were gathered in

about the roller, it would not flow towards it. The brush or brushes, which spread the dressing on the yarn and brush down the fibres, gently touch the above-mentioned roller; and, by wiping the dressing off its upper surface, convey the quantity required to the yarn.

In Plate VIII., fig. 1, is an end view, and fig. 2, a section of the improved apparatus for dressing yarn. *a*, is the yarn or warp to be dressed; *b*, is the brush; *c*, is a roller, working amongst the starch (in the starch-box *d*,) for giving starch to the brush; *e*, is the doctor, for regulating the quantity of starch given out to the brush; *f*, is a piece of sheet-iron, for preventing the dust from the brush falling amongst the starch; *g*, is a false or moveable side, for pressing the starch up to the roller; *i*, is the screw, for regulating the false side *g*; and *h*, is a screw, for regulating the doctor.

The patentee claims the application, by machinery, of undiluted dressing to yarns dressed by machinery for power-looms.

---

*To HENRY LEE CORLETT, of Summer-hill, Dublin, Gent., for improvements in railway waggons.*—[Sealed 29th March, 1853.]

THIS invention relates to a mode of constructing railway waggons so that the commodities which they carry—such as grain, turnips, potatoes, coal, coke, sand, lime, gravel, and ballast,—may be conveniently discharged by the action of their own gravity on an inclined plane. These waggons are more particularly applicable to the ballasting of railways,—the ballast being distributed by the opening of shoots in any required direction, with very little hand labor in the operation. The patentee remarks that coal waggons for railways have been before made with discharging hoppers in the bottom, and also waggons adapted for carrying either goods or coal, but not according to his arrangement; which permits of the contents of the waggon being discharged in the centre, between the rails, or to the outside of the rails, at either side, at pleasure; and the operation of discharging the ballast by any of the various shoots may go on while the train is in motion.

In Plate VIII., fig. 1, is a side elevation of a ballast waggon of the improved construction, the low-sided body of which is borne on the ordinary wheels and springs. The upper ends of the waggon body are fixtures; the sides *a*, are hinged to let down, so that the ballast may be thrown out at

the sides by hand or spade. Below the frame of the waggon is attached a hopper *b*, of timber, or wrought or cast-iron, forming inclined planes, closed by an iron or timber flap *c*, which, when opened, or partially opened, will serve to discharge the contents, either while the waggon is stationary or moving. Fig. 2, is a longitudinal section of the waggon, with the hopper, and a pair of wooden flaps *d, d*, lying horizontally over the opening of the hopper, in the position required for forming a flat bottom to receive the ballast when the hopper is not required to be used. Fig. 3, shews a transverse section of the waggon, as it is intended to discharge at the sides; *e, e*, are ridges, formed by planks laid lengthways along the waggon hopper; *f, f*, are hinges, attaching the flaps on lids *g, g*, which are shewn as folded towards the middle, so that the ballast, or other contents, may fill in towards the sides of the waggon, and be discharged by the flaps *c, c*, which are shewn open. The flaps *g, g*, may, when required, be folded towards the sides of the waggon; the ballast may fill in towards the centre, and be discharged by the flaps *h, h*, which are shewn closed in the figure.

Fig. 4, is a side elevation of a similar waggon, varying in the mode of its discharge by the hoppers, with flaps *i*. Fig. 5, is a longitudinal section, shewing the upper flaps *d, d*, (to form the flat bottom when let down), the hopper *b*, and the flap *i*. Fig. 6, is a transverse section. To the sloping-bottom sides *j, j*, are hinged the flaps *i, i*, which are acted on by notched rods *k, k*, in such manner that the flaps *i, i*, may hang vertically, or be closed at the same angle as the sloping-bottom sides *j, j*, to retain the ballast. Below the sloping-bottom sides *j, j*, are two sloping-bottom sides to the hopper *l, l*, which may be closed at the centre by two flaps *m, m*; but in fig. 6, they are shewn open for discharging the ballast or other contents between the rails. When the flaps *m, m*, are closed, one flap *i*, is held by the notched rod at the angle of the sloping-bottom side *j*,—forming a continuous incline for the ballast. The opposite flap is drawn up by the notched rod, so as to leave a space for the ballast to shoot out to one side, or which may be reversed to the other side; and by altering the angles of the flaps *i, i*, the ballast will shoot out to a greater distance than in the mode of flaps shewn at fig. 3. And the angles may be varied in the construction of the waggons, to suit the distances required.

The patentee remarks, that he lays no claim to constructing railway waggons with a hopper below, and upper flaps to form a flat floor; but he claims the arrangement of such flaps

in connection with hopper waggons, which are constructed for the purpose of distributing the load of ballast, or other commodities, either inside or outside the rails, at pleasure, in the various directions hereinbefore described, and illustrated by the figures; and also the construction and application of such hopper waggons without the upper flaps forming a flat floor, as hereinbefore described.

---

*To GEORGE HUTCHISON, of Glasgow, merchant, for improvements in treating oils and other fatty matters.—*  
[Sealed 10th February, 1853.]

THIS invention consists in a method of making oily ethers immediately, or directly, from neutral oils or fats (instead of preparing them from oily acids, as directed in treatises on scientific chemistry), and of obtaining the ethers in a state of greater purity and less dark in color than by the process of manufacture described in the specification of a patent granted to the present patentee, 18th Sept., 1852. In carrying this invention into effect, the patentee begins by separating from the oils or fats used, such impurities as they usually hold in solution, namely, fibrine, gelatine, and such other substances as they derive from the cellular tissues in which the oils were contained. This he accomplishes by means of chloride of lime, dilute sulphuric acid, or a weak solution of an alkali, either carbonated or in the caustic state, in the proportion of about two to three per cent. of the weight of the fat under treatment. He employs the chloride of lime chiefly in boiling with fat intended for stearic acid, and adds it before the lime for saponification, which has the effect of rendering the resulting acids very free from the accidental impurities of the tallow. In using weak solution of alkali, or dilute sulphuric acid (both solvents of fibrine and gelatine), he boils the fat intended to be used in the manufacture of oleic ether, for two or three hours, with one or other of them, and afterwardsedulcorates with water, and removes any remaining acid or alkali by mutual saturation.

Having in any of these ways rendered the fat or oil sufficiently free of foreign matters, it is fit to be converted into oleate of ethyle, methyle, or of other like base. The patentee remarks, that the previous decomposition of the neutral fat or oil is not a necessary step in the process; and that the oleate can be made directly from the neutral oil, by employing the oil in the manner directed (in the specification of the patent above cited) to be followed in preparing oily ethers

from commercial oleic acid. For the sulphuric acid employed in the process therein described, to decompose the alcohol when a neutral oil is used instead of the oleic acid, unites also with the glycerine or natural organic base of the fat; and the constituents of oleic ether, thus presented to each other in the nascent state, combine even more readily than when the hydrated oleic acid is used. The following is accordingly the routine of process pursued by the patentee:—he digests, by boiling in a suitable vessel or still, and over a fire of moderate intensity, a mixture composed of one part by measure of sulphuric acid, eight parts of alcohol, and four parts of oil or fat, until the union of the base of the alcohol with the oily acid is complete. At the end of each operation or “bout” he replenishes the residuary liquor with about an eighth part of the original charge of alcohol, and about a fourth or fifth part of the original quantity of sulphuric acid. This is done for the purpose of maintaining the etherifying power of the mixture, which is gradually reduced by the appropriation of the constituent and mixed water of the alcohol. The liquor, after being thus refreshed, is again digested with a new quantity of oil or fat equal to the first charge, and the boiling is again proceeded with, and continued until the union is complete, as before. The process is thus to be continually repeated, by adding fresh alcohol and sulphuric acid at each charge, and digesting anew till the alcoholic liquor in the digester has become so much weakened by the continual accumulation of water as to be unfit for further etherification. This is found usually to happen after five or six charges have been worked off.

The patentee claims the purifying of neutral fats or oils, to be used in the manufacture of oily ethers, from the natural impurities they derive from the cellular tissues in which they were contained, by treating them with chloride of lime, dilute sulphuric acid, alkaline solution, or like suitable re-agent; and the use of a neutral oil or fat, with an alcohol and a suitable acid, in the manufacture of oily ethers.

---

*To JOHN CHISHOLM, of Holloway, practical chemist, for improvements in the distillation of organic substances, and in obtaining products therefrom.—[Sealed 9th Dec., 1853.]*

THIS invention consists in distilling animal and vegetable bodies, mixed with salt of lime, potassa, or soda, to obtain cyanogen compounds. For this purpose the patentee employs close



vessels such as retorts now used in the manufacture of coal-gas, or a furnace so constructed that a stream of atmospheric air, highly heated and deprived of its oxygen, is made to pass through one or more chambers charged with organic bodies, such as fish or animal offal so mixed; or organic bodies mixed with any of the requisite alkaline substances aforesaid, are placed in a retort, and steam, at so high a temperature that it will decompose and carbonize the organic bodies, is passed through it. Example,—Take 100 lbs. of blood, and mix with it 5 lbs. of potassa (commercial potash), evaporate to dryness in an iron vessel: the dry mass is then to be placed in a retort, and submitted to destructive distillation. In connexion with the retort, an apparatus is to be attached, similar to that now in use for the manufacture of gas from coal. The gases escaping from the retort will be made to pass through one or more vessels, called purifiers. These vessels must be charged with any of the well-known chemicals in use for arresting ammonia,—such as chloride of calcium, or sulphate of lime, or solutions of sulphuric or hydrochloric acid, or bones, finely ground, that have been mixed with half their weight of sulphuric acid. During the distillation, nitrogen and hydrogen will be given off—forming ammonia; and in its passage through the purifying vessel, such ammonia will be arrested and fixed. The gas, after being deprived of its ammonia, will possess considerable heating and illuminating power, and may be conducted to and burned in the furnaces, or received in a gas-holder for the purpose of light. One fire will do for five retorts, and each charge will take about four hours in working off. The carbonaceous mass must be removed from the retort into a vessel, and excluded from the air until cold. The retorts, while hot, are again charged with another batch of blood and potash: indeed, it will be obvious, that when once the retort oven is heated, it would be a waste of fuel to allow it to get cold: the operation, therefore, should be a continuous one,—charging about every four hours, night and day. The mass that has been removed from the retorts, is to be placed, when cold, in an iron pan, and mixed with water, and brought near the boiling point,—stirring the mass well, so as to dissolve out of it all the soluble salts. It is then to be placed upon a filter; the carbon being well washed with the water, so as to obtain all the salt from it. The solution is now to be treated in the usual way so as to obtain crystallized ferrocyanide of potassium. The insoluble carbon may be dried and granulated, and sold to the sugar-refiners as a decolorator; or it may at once be mixed with half its weight of sulphuric acid, and used in the purifier for ar-

*Kohnstamm's, for Manufacturing Imitation Leather. 281.*

resting the ammonia, when it will become a valuable manure. Instead of making use of an open furnace for heating the retorts, steam, at a very high pressure, may be used, and passed directly through the mass in the retort. In the specification of a patent, granted to the present patentee, for "improvements in the production of artificial manures," dated 4th of June, 1853, a furnace is therein described, which, under certain circumstances, may be more economically used than retorts, viz., whenever the mass of materials is too bulky for a retort, or when fuel is very expensive, or when the materials to be operated upon are poor in nitrogen. Animal substances of every description are used,—such as hoofs, horn, hair, fish, and all animal offal. Such animal substances are also frequently mixed with peat or sea-weed, or both;—the proportion of the vegetable may vary: half the weight of the peat or sea-weed to the animal matter is, however, preferred. Moreover, the saline ingredients of the mixture are varied, according to the object sought to be obtained: thus, when cyanogen compounds are desired, potash is used, as described; but when ammonia is wanted, lime is employed instead of potash—such lime being either the common or chalk lime, or that obtained from the silica strata of the lower chalk, or, lastly, that from the magnesian lime-stone formation, or an admixture of these; or soda is used in place of potash for cyanogen and lime, and soda instead of lime and potash.

The patentee claims the distillation of organic substances by the methods described, mixed with the saline or earthy substances indicated, so as to obtain simultaneously, and by one operation, compounds of ammonia and cyanogen, or of ammonia only.

---

*To HEIMAN KOHNSTAMM, of Union-court, Old Broad-street, City, for certain improvements in the manufacture of imitation leather.*—[Sealed 21st December, 1853.]

THIS invention relates to a certain method of obtaining an improved kind of imitation leather. This method is as follows:—

First,—boil some linseed oil, in which mix a quantity of lamp-black sufficient to form a thick paste; taking care to stir the mixture in such manner that the lamp-black may be thoroughly incorporated with the linseed oil. This being accomplished, spread on a linen, woollen, half-woollen, or woolly cloth, which is to form the body of the imitation leather, a coat of this paste. This spreading is effected with what is commonly known by the name of a "coating or daub ma-

chine." The coat is then left to dry, in a room suitably heated. When dry, the coat is rubbed smooth with pumice-stone; after which, a second coat of paste is laid on in a similar manner; then a third coat, with less lamp-black. The same process of drying, and rubbing with pumice-stone, as previously described, is then gone through; after which, a fourth coat is laid on,—care being taken to put still less lamp-black in the mixture used: the drying and rubbing is then again repeated. These operations having been gone through, a coat of varnish is spread on, which must be dried and rubbed, the same as the coats given before; after which, another coat of varnish is laid on, dried, and well rubbed: the material is then in a fit state to be enamelled. When it be desired to give another color than black to the imitation-leather, instead of the fourth coat of the mixture of linseed oil and lamp-black being laid on, a coat or two of the desired color is given.

The patentee claims the treatment of linen, woollen, half-woollen, and woolly fabrics, as herein described, for the production of a material in imitation of leather.

---

*To FREDERICK CRACE CALVERT, of Manchester, Professor of Chemistry, for improvements in the treatment of naphthas and other volatile hydro-carbons, and in the application of the same to various useful purposes,—being a communication.—[Sealed 27th December, 1853.]*

THE patentee finds that pure benzine, and some of the volatile hydro-carbons obtained by the dry distillation of bituminous coals and shales, which also contain benzine, possess, to a high degree, the property of dissolving fatty or oily matters; and he proposes to apply this property of benzine to various useful purposes, hereinafter described. In order to render the various products that contain benzine suitable for their several applications, he submits them to the following treatment, the object of which is to destroy or remove some of the carburetted hydrogens which are mixed with them; and which, not being sufficiently volatile, interfere with the application of benzine.

He takes coal and shale naphtha (preferring for this purpose the limpid coal naphtha of commerce) and puts it in a suitable earthenware or leaden vessel, and adds to it sulphuric acid, in small quantities, until no more coloration is produced: consequently the quantity of acid employed will vary with the relative degrees of purity of the coal or shale naphtha.

The naphtha so treated he then washes with pure water, or with a solution of an alkali, and submits it to distillation in an ordinary still. These operations are to be repeated until it is sufficiently pure for the various purposes to which it may be applied. For certain purposes, on a large scale, as hereinafter applied, it is only necessary to take a commercial coal naphtha and distil it at a temperature which does not exceed 212° Fahr.

The first application that is made of the purified coal naphtha or nearly pure benzine is for the removal of spots and stains caused by fatty or oily matters, tar, paint, wax, or resin from cotton, woollen, silk, and other fabrics; and, owing to its great volatility, no mark or permanent odour remains on the fabrics operated upon.

The second application of the purified coal naphtha, or nearly pure benzine is for the removal of fatty or oily matters from hair, furs, feathers, and wools, and to the cleaning of gloves and other articles made of leather, hair, fur, and wool.

The third application of the purified coal naphtha or nearly pure benzine is for removing the fatty matters which exist naturally in wool.

The fourth application of the purified coal naphtha or nearly pure benzine is for the removal from wool, of tar, paint, oil, grease, and similar substances which are used by farmers for marking, salving, and smearing their sheep.

The fifth application of the purified coal naphtha or nearly pure benzine is for cleansing or removing the oily or fatty matters which are contained in cotton waste that has been used for cleansing or wiping machinery or other articles to which oil or grease has been applied.

To effect the several applications above named, purified coal naphtha or nearly pure benzine is simply applied to articles of small size by rubbing them with it; but, for other things of a larger size the several articles and fabrics to be operated upon are placed in a suitable vessel, and the purified coal naphtha or nearly pure benzine is allowed to flow into the vessel; and, after leaving them in contact for several hours, the fluid is run off, and the articles and fabrics are passed through squeezers, and the yarn is submitted to pressure, so as to remove a great portion of the purified coal naphtha or nearly pure benzine containing the paint, tar, grease, oily or fatty matters in solution, and which is separated from the liquids by distillation in a suitable vessel. The greasy, oily, or fatty matters, so obtained, may be applied in lubricating machinery and locomotive engines, and for other similar purposes.

The sixth application of this purified coal naphtha or nearly pure benzine is for making furniture paste.

To effect this object, one part of wax and one of resin is dissolved to two parts of purified coal naphtha or nearly pure benzine, by the aid of heat, until the whole is dissolved;—it is then allowed to cool, and the paste is fit for use.

The patentee claims, Firstly,—the application of purified coal naphtha or nearly pure benzine for the removal of spots or stains of fats, oils, waxes, paints, tars, or resins from cotton, woollen, silk, and other fabrics. Secondly,—the application of purified coal naphtha or nearly pure benzine for the removal of fatty, oily, waxy, tarry, resinous, or bituminous matters from hair, furs, feathers, and wools, and the cleaning of gloves and other articles made of leather; and also for the removal of fatty matters which exist in wool in a natural or manufactured state, as well as for the removal of wax, resin, paint, tar, and fatty matters that may have been applied to it. Thirdly,—the application of purified coal naphtha or nearly pure benzine for cleaning or removing the oily, greasy, or fatty matters that are contained in spent cotton waste. And, Fourthly,—the application of purified coal naphtha or nearly pure benzine for the making of furniture paste, as above described.

---

*To THOMAS SYKES, of Castleford, Yorkshire, Gent., for improvements in the treatment of soapy and greasy waters,—being a communication.*—[Sealed 21st March, 1853.]

THE object of this invention is the treating of soapy or greasy waters, in order to extract the grease therefrom, in a form available for various commercial purposes. The waters operated upon chiefly are such as have been used in the washing and cleansing of wool, spun wool, and woollen cloths; and the invention consists in the use and application of chlorine thereto to effect the above object.

In carrying out this invention the soapy or greasy waters are received into proper tanks, cisterns, or other vessels; and to these waters liquid chloride of lime (commonly called bleaching liquid) is added, in such quantity as to separate the water from the thick or muddy part, commonly called magma.

The quantity of liquid chloride of lime necessary for the purpose will vary according to the quality of the soapy or greasy waters; but the proper quantity to be applied to effect the separation of the water and magma will be easily and

readily ascertained by workmen having experience in the extraction of grease from soapy waters, by the processes now ordinarily in use for that purpose. On the liquid chloride of lime being applied, the soapy or greasy waters require to be well agitated, and then left to rest for a few hours, when the clear water will be found to have separated from the thick or muddy portion containing the grease. The clear water is then run off, and the thick or muddy part transferred to a suitable tub or other vessel, into which steam is to be introduced, and a small quantity of sulphuric or muriatic acid added, when the whole is caused to boil for a few minutes; after which it is filtered, and the sediment put into bags and pressed in proper presses heated by steam or hot air.

The patentee claims the treating of soapy or greasy waters by chlorine, in such manner as to separate the magma and greasy matter therefrom, as above described.

---

### Scientific Notices.

---

#### INSTITUTION OF MECHANICAL ENGINEERS BIRMINGHAM.

(Continued from p. 220.)

The following paper, by Mr. JOSEPH BEATTIE, of London, was next read:—

*On an improved locomotive engine.*

The economy of fuel in working locomotive engines is a subject of great importance to railway companies, and has attracted considerable attention for many years; but, at no period since the introduction of railways, has this subject been of such moment as at the present, by reason of the great demand for coal and the consequent increase of price.

The writer having been connected with one of the metropolitan railways for many years—and coal being so very expensive in the south—was led to the consideration of economy in fuel and the production of steam at the lowest possible cost;—the accomplishment of which appeared to be in burning coal in a fire-box, connected with the coke fire-box of the locomotive engine. This idea was strengthened by his observation of the working of coke ovens in the manufacturing of coke, where a great amount of flame and combustible gases was seen to pass off into the flues and chimney without producing any useful effect. When, it is remembered, that  $1\frac{1}{2}$  tons of good coking coal is required to produce one ton of coke, some estimate may be formed of the quantity of combustible gases that is thrown off.



The action of the coal and coke fire-boxes is as follows :—

The coal fire-box is attached to the back of the fire-box of the ordinary locomotive engine, and is placed partly below the foot-plate. The water space of this box is in connexion with that of the coke fire-box by two branch pipes at bottom, and two at top. The flame and combustible gases thrown off the coal-fire, pass into the coke fire-box through tubes, inserted into the intervening water space; and, to promote the combustion of the gases, by giving more time for better admixture, a curved fire tile-bridge, forming a sort of combustion chamber, is placed within the coke fire-box, fronting the tubes leading from the coal fire-box,—thereby checking the velocity of the flame in its passage over the surface of the coke-fire. The coal fire-box and the coke fire-box are each provided with separate ash-boxes, and close fitting dampers,—whereby the draught to each can be regulated with the greatest nicety, and independently of each other. The damper of the coke fire-box is generally kept nearly closed, and is only opened about  $1\frac{1}{2}$  inch with trains of 20 to 24 carriages; but the damper of the coal fire-box is generally kept full open, to admit the full draught of the blast; by which means, the coal-fire being excited to the utmost, the gases and flame pass into the coke-fire, and with them the air in a heated state;—the high temperature of the coke-fire is maintained, and more perfect combustion is the result. The combustion of the smoke is completely effected—the smoke being scarcely perceptible. An important practical advantage is gained from the circumstance of the ordinary coke fire-door being kept almost constantly closed (the door having been opened but three times, to put on coke, during the whole trip of 78 $\frac{1}{2}$  miles),—thus preventing the frequent rush of cold air cooling the fire-box and tubes, and thereby lessening the liability to leakage. In the present case, all the air entering at the coal fire-door, becomes highly heated before coming in contact with the main fire-box and tubes.

The next subject which attracted the author's attention, was the fact that all the water required for the supply of the engine, when working, was sent cold into the boiler. To obviate this evil, attempts had been made to warm the water in the tender by steam from the boiler before the engine started to work; but this was obtained at the expense of the fuel, and was only available so far as the first quantity of water in the tender would supply the engine. The next supply of water taken into the tender must necessarily be used cold, because the engine being on the journey could not afford to part with steam to heat the water, as in the first instance before starting;—and great loss of time in travelling was the consequence of this cold-water system of working.

To remedy this evil, various plans have been contrived and tested,—one of which is that attached to the Britannia engine. It consists of an oblong rectangular chamber placed in the smoke-box, and cast in one piece with the exhaust pipe, and communi-



cating to the upper part of the ordinary blast pipe;—this chamber is filled with a series of small tubes, fixed in tube plates at each end, and communicating with inlet and outlet chambers in connection with the engine, pump, and boiler. A branch pipe from this rectangular chamber communicates with an outer condensing apparatus fixed in front of the chimney, consisting of three upright pipes which stand on a cast-iron foundation, and are connected at top by a hollow cap. Two of these pipes are provided with jets or injections supplied by the cold-water pump, which draws its supply direct from the tender. There is an overflow pipe for conveying the water, after it is heated, to the hot-water pipe, and an overflow pipe leading into the tender, to convey any surplus water which may not be taken by the hot-water pump. The third upright pipe is provided with a disc or throttle valve, by which the exhaust steam from the lower chamber can be admitted into the condenser. An air-pipe is also inserted in the centre of the orifice of the blast-pipe, with a funnel-shaped mouth at the lower end, to catch the air and assist the blast.

The action of the apparatus is as follows:—When the engine is working, the exhaust steam from the exhaust steam-pipe, before it reaches the orifice of the blast-pipe, fills the lower chamber, forming a steam bath around the small tubes (through which the water passes into the boiler), and flows upwards into the outer condenser, where it is condensed by the jets from the cold-water pump; and such water, together with that obtained from the condensed steam, falling to the bottom of the condenser, is carried off, by the overflow pipe before named, to the hot-water pump, which propels it through the small tubes in the lower chamber. As the water passes slowly through these pipes on its way to the boiler, it absorbs heat from the constant supply of steam rushing to the condenser to be condensed, and enters the boiler at a very high temperature, and causing little or no check to the generation of steam in the boiler,—thereby maintaining the full power and energy of the engine. The average pressure in the experiment throughout the whole down trip, was 105 lbs., and 100 lbs. in the up trip;—the total fluctuation in pressure during the trip being very limited.

The advantages of the improvements just described are particularly apparent whilst ascending long gradients, as a high rate of expansion can be employed, the steam being cut off at 5 inches out of 21-in. stroke, or at less than 1-4th of the stroke during the whole time,—an important source of economy.

There are six engines adapted for burning coal and coke upon the above described principle, working on the London and South-ampton line (the Britannia being one of them), whose united running amounts to 100,360 miles, and the average consumption of fuel, coal and coke together, has been 15.6 per mile,—the Britannia having run 13,600 miles, with an average consumption of fuel of 17 lbs. per mile. In conclusion, it may be remarked,

that in no one instance have any of these engines failed in any part of the apparatus connected with these improvements. The same remark also applies to the 14 other engines (although in daily use) which are furnished with the heating and condensing apparatus. Should any mishap occur, the engine-driver can cut off the communication from the heating apparatus in an instant, and supply the boiler and work the engine in the ordinary way, and without stopping the train.

The following paper, by the Secretary, was next read:—

*On Berdan's crushing and amalgamating machine.*

The remarkable progress made in gold discovery during the last few years gives an interest to mechanical appliances for securing the precious metal by the complete reduction of its ores. This machine for pulverizing, washing, and amalgamating gold ores has recently attracted much attention from its mechanical merits, and its success in working.

The inventor had his attention called, a few years ago, to the serious loss of the precious metal, which was entailed upon the Californian gold-seeker by the imperfection of the appliances he could bring to bear upon his work. Determined if possible to remedy the evil, Mr. Berdan, in 1851, sent to California two practical engineers for the purpose of examining all the machinery there in use, and ascertaining from the mining people themselves what were the difficulties to be overcome, and what were the best means then at their disposal. All agreed that their best machines lost from 30 to 50 per cent. The only process on which they could rely, was applicable only on a very small scale: that was known as the "miner's assay," because it was the mode adopted at the diggings for testing the richness of the ore before beginning to work it. In this process mercury is put in a mortar; the ore to be tested is thrown in and covered with hot water; and the pulverizing is completely effected by the weight and combined rolling and grinding or rubbing action of the spherical end of the pestle; while the mercury is kept at the point of crushing, and is heated by the bottom of the mortar, which is kept hot by the boiling water contained in it. From this simple but perfectly effectual process are learned the following principles, on which a perfect gold-reducing machine should operate.

1.—It should grind the ore to an impalpable powder; in order to perform which, it should have a combined rolling and rubbing action. Without perfect pulverizing, the metal would not be effectually exposed to the action of the mercury.

2.—It should amalgamate at the instant of crushing; otherwise the small particles of gold may escape, by floating off on the waste water, or by becoming coated with the mud or refuse, and thus protected from the action of the mercury.

3.—The amalgamation should take place at the point of crush-

ing, or below the surface of the mercury; and in order to do this, the mercury must be kept constantly at the crushing point. This is of great importance, as the surface of mercury is covered at all times with a film of oxide, which must interfere materially with the perfection and rapidity of its action in amalgamating. But, in addition to this, it is always covered with the mud and refuse from the grinding operation; which covering much increases the difficulty of bringing the finely-floured gold into perfect contact with the mercury. At the bottom of the mercury, where it is perfectly pure, both of these difficulties disappear.

4.—It should heighten the affinity between the mercury and the gold by the addition of heat. The increase of affinity produced by heat may be illustrated by dipping a sovereign in a spoonful of cold mercury and observing how much it will take up; then heating the mercury over a lamp, and noticing the greatly-increased quantity that will cling to the coin.

5.—It should lose no mercury in the process. The loss of a material so expensive has been a serious evil in amalgamating machines. It has hitherto been broken up in the process of grinding, and passed off in a finely-divided state with the refuse.

These five principles are found in the miner's assay; and to combine them in a machine on a large scale was the object Mr. Berdan had in view, and which he has attained by his apparatus, with the additional advantage of avoiding the expense attending the heating of water in large quantities.

The construction of the apparatus is simple.\* The machine in its present form is a great improvement on the first one made by Mr. Berdan. The first machine which was exhibited at work in America, in December, 1852, had but one ball, which weighed only 1700 lbs., and was attached by a universal joint to the central shaft. Several of these machines were put to work; but, although they were more efficient than machines before used, especially when employed upon refuse or "tailings" which had already been partially pulverized, they were considered as too small, and far from perfect. A few of them were set up in California and North Carolina, and obtained from "tailings," supposed to be practically exhausted, 19 per cent. of the original riches of the ore. Only eight of these small machines still remain in use; all the others having been exchanged for the large and improved machines now at work in England. The first improvement made on the small machines was increasing the ball to three times its original weight. It was still, however, left attached to the centre shaft. A great increase of efficiency was the immediate result of this modification. The small ball which had been rejected, was, on one occasion, and merely as a matter of curiosity, placed in the basin behind the large one, when it was found to steady the motion and greatly increase

\* As we have recently published the Specification of Mr. Berdan's patent (see Vol. XLIV., p. 245), it will be unnecessary to repeat the description of his machinery as given in this paper.

the rapidity of the reduction. Finally, it was determined to disconnect the large ball from the shaft, and run both balls loose. This was tried, and the result was perfectly satisfactory, and left the large machine in its present condition.

This machine is not simply a crusher, but it does all the work necessary to secure the desired product in combination with mercury. It crushes, washes, and amalgamates, at one and the same operation. The simplicity and durability of its parts, small amount of friction in its gearing, and the moderate power required to work it, render it an important addition to mining machinery.

It is found that a machine consisting of four basins in one frame, will pulverize, wash, and amalgamate about 20 tons of ore, of average hardness, in ten hours, with from 15 to 20-horse power. Any number of basins can be used in one frame, and driven by one main shaft.

The peculiarity of this invention does not consist in using balls and basins, but in the inclining of the shaft on which the basin revolves, which keeps the mercury always at the crushing point, and causes the balls to work by gravity;—in the production of a combined rolling and grinding action by the contact of the balls;—and in the addition of heat to the mercury, by means of the furnace below the basin, increasing the chemical affinity of the mercury and the gold. By the inclination of the basin, the mercury and balls are kept always at the lowest point of the basin, and thus the amalgamation is insured at the instant and at the point of crushing, and below the surface of the mercury. The heating of the mercury is also facilitated by this arrangement; for it is obvious that if the bottom of the basin were horizontal, and fire were applied below, the heat would pass through the iron and the mercury to the water above, leaving both metals comparatively cold; but, by the inclination of the basin, the bottom is exposed for more than half of each revolution to the direct action of the fire, without having water above to carry off the heat. Thus, when it passes at a high temperature under the mercury, it effectually communicates heat to that metal, and places it in the best condition for seizing upon the gold as fast as it is liberated.

This crushing machine has attached to it an auxiliary machine called a “separator,” which entirely prevents loss of mercury, and is as simple in its construction as the principal machine. The mode of operation of the machine is as follows:—A quantity of mercury, several inches deep, is placed in the bottom of a tub having rotating wings which are so adjusted that they will just clear the surface of the mercury when the machine is in motion. The hollow shaft (on which the wings are loosely mounted, and which carries at its lower end hollow horizontal arms) is rotated in one direction, and the wings in an opposite direction. The pulverized ore or refuse from an amalgamating machine, in suspension in water, is fed in through the hollow shaft, and passes into the arms at its bottom, whence it is driven by centri-

fugal force through narrow slot-shaped openings at the end and back part of the arms, and passes forcibly out in a thin sheet underneath the mass of mercury in the bottom of the tub.

This mercury, by affinity, retains all the floured mercury which may have been broken up in the process of amalgamating, and seizes upon all particles of gold which may have escaped the previous operation; while the pulverized matter, suspended in water, rises to the top of the mercury, and being kept in suspension by the operation of the wings, is driven to the top of the tub, and passed off through an exit spout. This machine need not be confined to the separation and saving of floured mercury, but it may also be employed as an independent amalgamator.

In reference to the average expense of the process, the most unfavorable estimate that has been made on this point is that of Professor Ansted, who states the case as follows:—

## PLANT.

Cost of a nest of 4 basins . . . . .	£2400	
Conveyance to mine, foundations and fittings, house, &c. . . . .	300	
	—	2700
Cost of a 25-horse-power engine—complete . . . . .	1250	
Engine and boiler house . . . . .	150	
	—	1400
Sundry incidental charges . . . . .		100
		—
Total cost of plant . . . . .		£4200

## ANNUAL CHARGES.

Deterioration and replacement of machine, 60 per cent. . . . .	£1440
Ditto ditto of engine and fittings, 10 per cent. . . . .	150
Interest on cost of plant, at 5 per cent. . . . .	210
	—
Total annual charges . . . . .	£1800

## DAILY CHARGES.

Proportion of annual charges on each working day . . . . .	£6	0	0
Wages and salaries per day, working day and night . . . . .	2	10	0
Coal, 2½ tons at 15s. . . . .	1	17	6
Oil, waste, tallow, tools, and sundries . . . . .	2	8	
Loss of mercury, and proportion of laboratory expenses . . . . .	4	6	
Crushing 16 tons, at 4d. per ton . . . . .	5	4	
		—	
Average daily charges . . . . .	£11	0	0

The four basins crushing and amalgamating not less than 16 tons, on an average, per working day—the mean cost would thus be 13*s.* 9*d.* per ton.

Mr. Readwin, after twelve experiments, estimated the cost at 2*s.* 6*d.* per ton. The cost would probably vary from 5*s.* to 10*s.* per ton, according to the hardness of the ore operated upon.

About 600 trials of ores, gozzans, and mundics, mostly British, have been made with these machines since the 24th of October last, when they were first worked in London. In most of these trials gold was obtained, in quantities varying from a mere trace up to several ounces per ton. The gozzans have been remarkable for the regularity of the yield. The results of such a large number of trials, most of them public, would seem to settle the long agitated question of the existence of gold in England in remunerative quantities; three dwts. to the ton will fully pay the cost of reduction, while most of the ores yield from 15 to 30 dwts. per ton.

---

May 3rd.

The following paper, by Mr. EDWARD J. PAYNE, of Birmingham, was read:—

*On a new railway train signal.*

Numerous have been the attempts and great the skill brought to bear on the subject of providing an efficient means for communicating signals between the guards and drivers of railway trains, and still the many and serious accidents constantly arising give warning equally of the vital importance of the subject and the deficiency of the present contrivances.

The principle of construction that appears the most primitive and simple, is, perhaps, a metal rod running the entire length of the train, from the guard's van, at the tail, to the engine; and coupled between the carriages by link-rods or chains;—but the curves of the line and the "buffing" of the train render this impracticable. To avoid these evils, a rope connected with a bell on the engine has been tried; but here as great a difficulty arises from the amount of slack in the rope, on account of the constantly varying distances between the carriages in a train of ordinary length causing the rope to yield some feet before the tension would become fixed,—nor would the guard then feel assured that the signal had been given.

Another mode consisted in applying a flexible tubing the whole length of the train, and terminating in a whistle on the engine, which was sounded and the signal given, by the guard blowing into the mouthpiece at the opposite extremity of the tube. This might answer well enough for a few feet, or even yards, but air being an extremely compressible fluid, no man's lungs could produce a whistle by blowing into any great length of tubing. Electrical agency has been called into requisition,—but here several

obstacles have also to be encountered: the extreme delicacy of the apparatus, its liability to derangement, and consequent interruption of the current, together with the loss of time attendant on the interpretation of the signal, at a crisis when every moment is precious—has rendered the application of this method precarious and uncertain.

But supposing that any or all of these methods were found to answer in the duties assigned to them, there still remains one point (of no second-rate importance) which, by their aid could never be attained. It is this:—that the driver's attention may be called,—but he knows not for what purpose. It may be to stop—something may be wrong in the train, a tyre thrown off, or an axle broken; or what is just as likely, it may mean “go on,” “full speed,” or “express coming up behind.”

The signal brought before the meeting, is the invention of Mr. Alfred Bird, of Birmingham. It works on the principle of hydraulic pressure,—the liquid employed being an anti-freezing mixture, consisting of alcohol and water. It consists of two cases, the smaller one of which is placed on the engine or tender—the larger one, in the guard's van;—each being furnished with a signal-board containing the same code of signals. In the interior of the larger instrument there is a drum, mounted on a hollow spindle, firmly screwed into the back of the case. This drum is for the purpose of receiving a coil of gutta-percha tubing,  $\frac{3}{8}$ -ths of an inch diameter in the bore, but very thick in proportion; and it may be of any necessary length for connecting the two instruments. These instruments consist of similar parts,—a working pump barrel, connecting tubes, and a lever handle. It is essential that both the barrels, the connecting tubes, and the flexible tubing, throughout its entire length, should be completely charged with the liquid, and uninterrupted communication obtained; whilst, at the same time, the drum is required to revolve on the spindle. This is effected by employing a supply-cock of peculiar construction, in connection with the hollow spindle. A short length of metal tubing connects the cock and the flexible tubing together, and prevents any fracture in the latter, which might arise from too sudden coiling round the drum.

A rack attached to the piston-rod of each force-pump, works simultaneously therewith. On the rack is a set of catches corresponding with the number of the signals: these catches (on the passage of the rack downwards) act on a hammer, causing it to strike a gong. An index or pointer on the lever hand, points to the signal intended to be communicated. There are two reservoirs of liquid, one of which is connected with the barrel of the guard's signal by a supply-pipe, which is provided with a stop-cock, for the purpose of regulating the admission of liquid. The smaller instrument, intended for the driver, has the parts nearly all of them duplicates of those described: the rack being differently placed, to admit of the signal-board being screwed to the front of it,

without impeding the operation of the hammer and large gong, and the handle passing through the side of the case.

The instrument exhibited to the meeting contained a length of 450 feet of tubing coiled on the drum, and is worked in the following manner:—If the guard requires to signal the driver to “stop,” he raises the hand-lever until the index points to that word. The liquid is forced along the tubing, and, depressing the piston in the opposite instrument, forces down with it the rack and signal-board. The gong is struck, and the word “stop” appears in a slot in the front of the box. The driver then shuts off the steam, and raises his lever until the word “yes” appears in the slot; thus returning the signal to the guard. Should he fail to do so, the guard again signals him “return signal.” To take another case:—The driver sees a train in advance of him; he shuts off steam and signals the guard “on break.” The guard, even if he be asleep, must hear the gong: he puts on the break and returns the signal “yes.”

The severance of a train, by the breaking of a coupling, is no uncommon accident; and it is intended to make this apparatus self-indicating, immediately a separation has taken place. The driver, altogether unconscious, probably runs on with the fore part of the train,—the remaining carriages following for a time by their own momentum. Should this accident occur, the sudden uncoiling of the remainder of the tubing gives timely notice thereof; for in connection with the drum is another bell and catch, which is violently sounded by the rapid revolution of the drum, and apprises the guard of the accident; and he, although the driver may be one hundred yards ahead, can immediately signal him to stop.

It now only remains to describe the contrivance for connecting and disuniting any number of lengths of the flexible tubing, which may be requisite in adding to or taking from the number of carriages in a train. In this coupling there are a pair of common gas-cocks with union screw; but it is evident that there will be a space between the stop and the mouth of each cock, which, when connected, would be filled by some of the liquid that would escape immediately the coupling was separated. To obviate this, that space is rammed tight with a porous metallic stuffing, consisting of wire gauze, rolled up closely and forced in. This affords a medium, through which the liquid may be forced; but it is prevented by capillary attraction from escaping without pressure; consequently not one drop will be lost while the coupling is open: and to insure that the coupling be not disconnected until the stop-cocks have been turned off, a plate of metal is secured to them, having slots cut through it, passing over the thumb-pieces only when they are at right angles with the tube, when the communication is shut off; affording a species of lock, and guarding against inadvertence of the person having charge of the signals.



It is proposed to place the tubing either on the roofs or under the steps of the carriages; and probably, in some cases, it would be preferable to run it along that side of a train on which the doors are locked.

---

In answer to a question from the Chairman, Mr. Bird said, a complete trial of the apparatus had been made with two trains of about 14 carriages, from Birmingham to Wolverhampton and back (a total distance of 50 miles); and the result of the trial was entirely satisfactory. The different signals were communicated instantly, and without any difficulty, from the guard to the driver, and back again, at any speed and under all circumstances, and no imperfection or error was found in the transmission of the signals. The simplicity and convenience of application of the apparatus was shewn by the tube not being connected until after the train had started, when it was drawn off the drum in the guard's van, carried over the tops of the carriages, and connected to the signal-box on the tender whilst the train was travelling; and the apparatus was found at once capable of transmitting signals.

Mr. Maher said he had witnessed the trial of the apparatus, and had travelled with the train throughout the trip; and he was much struck with the promptness and certainty with which the signals were given between the guard and driver in all cases: the apparatus proved quite successful.

Mr. Woodhouse remarked, that a great length of train would cause a difficulty in the employment of the tube. The number of couplings required in the whole length to prevent delay in adding or detaching carriages in different parts of the train, as might be requisite, would add to the risk of a coupling being left open; and this would cut off the communication of signals, and cause part of the liquid to be pressed out of the tube,—requiring fresh adjustment of the apparatus before it could be used to send signals again.

Mr. Bird shewed the construction of a coupling in the tube, and the short time required to uncouple the tube and connect it again. He said, that although the possibility of a coupling being left unfastened could not be prevented, except by careful inspection, the additional time and trouble required for the purpose was very inconsiderable; and he thought the clip shutting down over the coupling would be found a sufficient guard against either of the cocks being left open, as it could not be lifted off to get at the coupling screw without first shutting both the cocks.

In answer to the Chairman's inquiry as to what was the relative size of the pump and the tube,—Mr. Bird said, that the tube was  $\frac{3}{4}$  in. bore, and the pump barrel 1 in. (about seven times the area); but he proposed trying the next apparatus with a pump of the same diameter as the tube, which he expected would be preferable in working.

The Chairman thought it more probable that the greater area of the pump over the tube was requisite for the efficient communication of the motion through the whole length of the tube, by producing a sufficiently sudden impulse, or concussion, and the requisite degree of compression on the air mixed with the liquid in the tube. There would, unavoidably, be always a portion of air in the tube, as was found to be the case in water-mains; but this would not prevent a concussion being transmitted through the tube. It was found when too great a quantity of air was left in water-mains, that the concussion of each stroke of the pumping engine was transmitted to a very long distance, even as far as five miles,—causing the bursting of the mains.

---



---

#### PROVISIONAL PROTECTIONS GRANTED.

*[Cases in which a full Specification has been deposited.]*

1823. Henry Bauckham, of New-walk, St. John, Southwark, and Howard Glover, of the same place, for certain improvements in the construction of an apparatus or instrument for securing or fastening corks or stoppers into bottles and other vessels, used to contain effervescing or other liquors, or wet or dry ingredients, and for other similar purposes.—*[Dated August 19th.]*
1850. Theodore Schwann, of Neuss, Prussia, for improvements in machinery or apparatus worked or actuated by helicals or spirals.—*[Dated August 23rd.]*
1894. Pierre Amable de Saint Simon Sicard, of Paris, for improvements in apparatus for raising and destroying submerged vessels, rocks, and other bodies; and also in apparatus to facilitate the examination of submerged bodies.—*[Dated August 29th.]*
1904. John Heather, of Bedford-court, Covent-garden, for an invention consisting of sugar-nippers combined with sugar-tongs, to be used for the purpose of cutting or breaking lumps of loaf and crystallized sugar, and distributing the same at the tea and breakfast table,—to be called “Blackwell’s combined sugar-nippers and tongs.”—*[Dated August 31st.]*

*[Cases in which a Provisional Specification has been deposited.]*

1097. Jean Marie Rabier, of Paris, for certain improvements in keels of ships and vessels.—*[Dated May 17th.]*
1147. Louis Émile Dufour, of Paris, for improvements in breech-loading fire arms.—*[Dated May 23rd.]*
1279. Julian Bernard, of Club Chambers, Regent-street, for improvements in stitching and sewing machines, and in machines for securing and ornamenting parts of garments and other materials.—*[Dated June 9th.]*

1349. Robert Reeves, of Bratton Westbury, Wilts, for improvements in drills for drilling liquid manure.—[*Dated June 20th.*]
1405. Henri Manteguès, of Rouen, for improvements in the manufacture of boots, shoes, goloshes, or in shoe-making generally.—[*Dated June 26th.*]
1477. Thomas Grubb, of Dublin, for improvements in microscopes.—[*Dated July 5th.*]
1485. William Neuzam Nicholson, of Newark, for improvements in haymaking-machines; part of which improvements is applicable to carriages generally.
1490. Nicholas Michael Caralli, of Glasgow, for improvements in the manufacture or production of ornamental fabrics.

*The above bear date July 6th.*

1504. John Henry Johnson, of Lincoln's-inn-fields, for improvements in the manufacture of carbonates of soda,—being a communication.—[*Dated July 8th.*]
1531. William Armand Gilbee, of South-street, for improvements in the application to weaving of certain textile plants not hitherto employed, either alone or in combination with silk, cotton, and other fibrous substances,—being a communication.—[*Dated July 12th.*]
1544. Robert James Mary'on, of York-road, Lambeth, for improvements in the construction of, and arrangement of, and application of, steam-engines, for the better means of transmitting motion, and of applying steam or other motive power.—[*Dated July 13th.*]
1575. Charles Maybury Archer, of St. James's-gardens, Haverstock-hill, for treating all kinds of paper whereon any printing, engraving, engrossing, letter-writing, or lithographing, has been printed or impressed, so that the said printing, engraving, engrossing, letter-writing, or lithographing, may be completely removed, discharged, or obliterated from the said paper, and so that the said paper may be readily re-used in sheets, or be reconverted and worked up again into its primitive pulp by the ordinary method, and be again manufactured into and be used as paper.—[*Dated July 18th.*]
1599. Sir John Scott Lillie, of Pall Mall, for improvements in fire-arms.
1608. Richard Archibald Brooman, of Fleet-street, for an improvement in treating raw silk fabrics while being dressed and dyed,—being a communication.

*The above bear date July 21st.*

1621. Richard Roberts, of Manchester, for improvements in machinery for punching, drilling, and rivetting.
1623. Auguste Castets, of Paris, for the extraction of a substance for supplying the place of quinine.

*The above bear date July 24th.*

1628. Hugues Champonnois, of Chaumont, and Jean Baptiste Bavelier, of Dijon, for improvements in the manner of treating beet-root, and all other sugary and feculent vegetables.
1631. Alfred Vincent Newton, of the Office for Patents, 66, Chancery-lane, for an improvement in the process of converting wood into paper,—being a communication.

*The above bear date July 25th.*

1647. William Littell Tizard, of Aldgate, for improvements in fermentation, and in apparatus employed therein.
1648. Pierre Victor Delaye, of Paris, for improvements in printing blocks.
1649. Constantin Luques, of Boulevard St. Martin, Paris, for an improved centrifugal governor.

*The above bear date July 26th.*

1664. Robert Henry Thompson, of Old Charlton, Kent, for a universal self-acting sawing-machine.—[Dated July 28th.]
1679. Auguste Edouard Loradoux Bellford, of Castle-street, for an improved method of engraving,—being a communication.—
1680. Edwyn John Jeffery Dixon, of Bangor, for improvements in apparatus for teaching reading and arithmetic.

*The above bear date July 29th.*

1683. Jean Chrilottome Denis Demay, of Leicester-square, for preventing the accidents on the railways with the aid of a right line of iron, and in stopping the trains almost instantaneously,—being a communication.
1687. Alfred Vincent Newton, of the Office for Patents, 66, Chancery-lane, for an improved mode of extracting sulphur from compounds of India-rubber and sulphur,—being a communication.

*The above bear date July 31st.*

1704. Henry Gerner, of Moorgate-street, for improvements in the construction of omnibuses; parts of which are applicable to carriages generally.
1706. Charles Tetley, of Thurlow Villas, Dulwich, for improvements in rotatory engines, to be worked by steam or water.

*The above bear date August 3rd.*

1708. Edward Hallen, of Cornwall-road, Lambeth, for certain improvements in chairs, chair bedsteads, and other seats and bedsteads.
1710. Maurice Atkinson Dayley, of London-street, Fitzroy-square, for improvements in furnaces for the purpose of consuming smoke and economizing fuel.
1712. Edmond Hamilton, of Edinburgh, for improvements in the manufacture or production of beverages or occasional drinks.

1714. Charles Weightman Harrison, of Richmond, for improvements in obtaining and applying electric currents, and in the treatment of certain products derived in obtaining the same; part or parts of which improvements is or are applicable to the production of motive power.

*The above bear date August 4th.*

1716. Charles Frederick Stansbury, of Cornhill, for improvements in machinery for making rope,—being a communication.

1718. Charles Frederick Stansbury, of Cornhill, for improvements in cut nail machines,—being a communication.

1720. John Cunningham, of Beith, Ayr, N.B., for improvements in the preparation or production of printing surfaces.

1722. John Henry Johnson, of Lincoln's-inn-fields, for improvements in the manufacture of railway and other wheels,—being a communication.

*The above bear date August 5th.*

1723. George Wagstaff Yapp, of Cornhill, for an improvement in steam boiler and other furnaces.

1724. Edouard Alexandre, of Paris, for improvements in concertinas.

1725. George Addison Cox, of Lochee, Dundee, for improvements in machinery or apparatus for winding yarns or thread.

1726. Jean Baptiste Toussaint Aubert, and Fedele Antonio Cossus, of Paris, for improvements in obtaining fibre from woollen rags.

1727. John Hall Brock Thwaites, of Bristol, for improvements in apparatus to facilitate the communication by cypher.

1728. John Knight, of Stamford, for improvements in engines to be worked by steam, air, or other fluids or liquids.

1729. Emmanuel François Duquesne, of Brussels, for an improved mode of manufacturing gas for illumination.

1730. Samuel Lucas, of Dronfield Foundry, near Sheffield, for an improved mode of manufacturing steel.

*The above bear date August 7th.*

1731. Henry Dircks, of Moorgate-street, for improvements in steam-engine boiler furnaces, and other furnaces for the prevention of smoke.

1732. Thomas Waterhouse, of Sheffield, for improvements in machinery for cutting files,—being a communication.

1733. Hugh Stoy, of St. John's-road, Battersea Rise, for stopping of engines and carriages on railways, and also vehicles of every description on the common roads.

1734. Joseph Hulme, of Manchester, for improvements in apparatus for preventing the explosion of steam-boilers, for measuring the pressure of steam and other fluids, and in heating water for the supply of steam-boilers.

1735. Henry Turner, of Leeds, for improvements in preparing hides, and in cutting them into straps for driving machinery.

1736. Henry Moorhouse, of Denton, Lancashire, for improvements in certain parts of machinery or apparatus used in preparing cotton, wool, or other fibrous materials to be spun.
1737. Charles White, of Tatchbrook-street, Pimlico, for improvements in printing blocks for printing ornamental or decorative paper.
1738. Antoine Corvi, of Paris, for improvements in musical instruments.
1739. Alexander Ogg, of Glasgow, for a new composition, applicable to the cementing of leather.
1740. Edward Webb, of the City of Worcester, for an improved power loom for weaving horse-hair, and other fibrous substances where the weft or shoot is not composed of a continuous thread.
1741. William White, of York Villa, Kensington Park, for an improvement in deodorizing the contents of cesspools, privies, and also like matters in other places.

*The above bear date August 8th.*

1742. William Charles Pitt, of Pimlico, for improvements in the construction of knobs and roses, used with locks, latches, and such like fastenings as are constructed with spindles,—being a communication.
1743. Thomas Kaye, of Grange Moor, near Dewsbury, for improvements in the means of reversing the direction of motion of steam-engines.
1744. Plato Oulton, of Dublin, for improvements in obtaining motive power.
1745. William Armand Gilbee, of South-street, for improvements in hydraulic machines,—being a communication.
1746. Jean Baptiste Ambroise Marcellin Jobard, of Brussels, for a new system of pump.
1747. John Lucas, of Lincoln, for improved machinery for pulping or reducing vegetable substances.
1748. John Livesey, of New Lenton, for improvements in the manufacture of fringes.
1749. John Hackett, of Derby, for improvements in the manufacture of garments or of parts of garments, or of appendages or appliances to garments.

*The above bear date August 9th.*

1750. William Houghton Clabburn, of Pitt-street, Norwich, for improvements in the manufacture of shawls and scarfs.
1751. Edward Wills Uren, of Foggintor, Dartmoor, for a new or improved machine and arrangements of machinery for the manufacturing of bricks, pipes, tiles, and artificial stone, from clay and other plastic materials.

*The above bear date August 10th.*

1752. Edward Monson, of Birmingham, for new or improved machinery for manufacturing, cleaning, and polishing Daguerreotype plates.
1753. Samuel Bickerton, of Oldham, for an improved gas-light governor or regulator; which invention is also applicable to regulating the supply of water and other fluids.
1754. Joseph Riemann and Frederick Saueremann, of Breslaw, Prussia, for improvements in fire-arms.
1755. Peniston Grosvenor Greville, of Lombard-street, for improvements in the manufacture of cards for working wool and cotton,—being a communication.
1757. John Tennant, of Shields Monkton, Ayr, N. B., for improvements in grubbers for agricultural purposes.
1758. Walter Blundell, of New Broad-street, London, for an improved apparatus for treating or preparing any part of the human body requiring to be surgically operated upon, for the purpose of totally or partially benumbing the sense of feeling at the desired part of the human body.

*The above bear date August 11th.*

1759. Thomas Cox, of Southampton-street, Strand, for improvements in stools, cushions, and hassocks.
1760. John Gibson, of Paddington, for improvements in the manufacture of railway wheels.
1761. Thomas George Taylor, of King's Arms-yard, for the use or application of the stalk of the hop-plant in the manufacture of paper, pasteboard and millboard, cordage, rope, and textile fabrics.
1762. William Woodcock, of the Earl's-court Brewery, Brompton, for an improvement in the combustion of fuel.
1763. Pierre Athanase Roguier, of Paris, for a new mode of treating and curing varicose veins of the human body,—being a communication.
1764. George Weston, of Sheffield, for an improved veneering apparatus.
1765. John Benjamin Daines, of Charles-place, De Beauvoir-square, for an improved mode of treating surfaces of stone, plaster, and cement, for the preservation of the same from decay.
1766. John Petrie, jun., of Rochdale, for improvements in machinery or apparatus for drying wool.

*The above bear date August 12th.*

1767. James Tolputt Stoneham, of Manchester, for improvements in the mode or method of rendering woven fabrics waterproof, and in the substance or composition used for the purpose.
1768. Henri Louis Edmond Désiré Hennebutte, of Esquermes lez Lille, Nord, France, for improvements in the manufacture of varnishes.

1769. Joseph Moore, of Manchester, Samuel Beswick, of Failsworth, and Benjamin Wilson, of Woodhouses, for certain improvements in the manufacture of piled goods or fabrics.
1770. Peter Haworth, of Manchester, for an improved belt, band, or strap fastener.
1771. William Todd and Jacob Todd, both of Heywood, for certain improvements in power-looms for weaving.
1772. William Crosland, of Hulme, for certain improvements in machinery or apparatus for governing or regulating the speed of steam-engines or other motive power engines.
1773. Henry Smith, of Smethwick, for improvements in the manufacture of wrought-iron wheels.
1774. Joseph Beardmore, jun., of Stowage, Deptford, for improvements in supplying air to furnaces.

*The above bear date August 14th.*

1775. John Greaves and Charles Michael Greaves, both of Birmingham, for an improvement or improvements in the manufacture of certain kinds of spectacle frames.
1776. Benjamin O'Neale Stratford, Earl of Aldborough, of Stratford Lodge, Wicklow, Ireland, for improvements in projectiles.
1777. John Norton, of Cork, for improvements in bolts and projectiles for fire-arms.
1778. John Withers Taylor, and Charles Jackson Taylor, of Nottingham, for the employment of adhesive imitation embroidery to lace, muslin, silk, woollen, cotton, or other fabrics,—such embroidery being formed of cut, pressed, or stamped patterns of velvet, crape, or other materials.

*The above bear date August 15th.*

1779. Robert Counce, of Bolton-le-Moors, for certain improvements in machinery for preparing cotton and other fibrous materials.
1780. John Coupland, of Southampton, for the preparation and manufacture of a pulp to supersede the use of rags and similar fabrics in the manufacture of paper.
1781. Thomas Atkins, sen., of Oxford, for improvements in the mode of preparing land, constructing machinery, and other apparatus for applying and maintaining an under current arterial circulation of fluid manure, gases, vapours, and air, to the seeds and roots of plants.
1782. William Charlton Forster, of Hatton-garden, for the manufacture of gas for illumination and heating from materials not hitherto employed for such purpose.
1783. Edward Manière, Jean Baptiste, Adolphe Piette, and Jean François Mermet, all of Bedford-row, Holborn, for the conversion of peat into colors.
1784. Francis Higginson, of King William-street, for effecting certain improvements in the mode of laying, directing, and



- aiming with ordnance, ship, garrison, and battering guns and field-pieces of every description.
1785. Samuel Frankham, of Greenland-place, for improved means of consuming smoke and economizing fuel in furnaces.
1786. Robert Carr and William Crossby, both of Sheffield, for burning or consuming smoke in furnaces and fires for engine-boilers.
1787. William Kennard, of Little Queen-street, Holborn, for improvements in attaching door or other knobs and handles.
1789. William Siddons, of Birmingham, for improvements in locks for guns and other fire-arms.
1790. John Lamb and Thomas Lamb, both of Kidderminster, for improvements in Jacquard machinery, and in the apparatus connected therewith.
1791. Edmond Hamilton, of Edinburgh, for improvements in the manufacture or production of beverages or occasional drinks.
1792. Thomas Wallworth, of Manchester, for improvements in purifying and treating grain, and in dressing flour, and in machinery for these purposes.
1793. William Johnson, of Lincoln's-inn-fields, for improvements in furnaces and in the consumption or prevention of smoke,—being a communication.
1794. William Johnson, of Lincoln's-inn-fields, for improvements in windlasses,—being a communication.

*The above bear date August 16th.*

1795. Charles Cowper, of Southampton-buildings, for certain improvements in the felting of hats, and in machinery for that purpose,—being a communication.
1796. John Turner Wright and Edwin Payton Wright, both of Birmingham, for an improvement or improvements in the manufacture of ropes, cords, lines, and twines.
1797. John Hackett, of Derby, for the manufacture of new and improved fabrics of cotton and of linen, and of cotton and linen combined.
1798. Charles Blake, of St. Leonard's, for an improvement in, or addition to, doors, and door and window-frames.
1799. Robert Griffiths, of the Strand, for an improvement in the manufacture of brushes.
1800. Julian Bernard, of Club-chambers, Regent-street, for improvements in the manufacture of boots and shoes, or other coverings for the feet.
1801. Louis Christian Kœffler, of Rochdale, for improvements in extracting colouring matter; also applicable for extracting size or glue from animal substances.

*The above bear date August 17th.*

1802. Sara Spaldin, of Hull, for improvements in apparatus for preventing loss of life at sea.

1803. Edward Trenergy, of Stourbridge, for a new or improved machine for driving piles.
1804. William Baker, of Birmingham, for a new or improved method of manufacturing the bezils or rings used in glazing the dials of clocks and barometers, and for other like purposes.
1805. Joseph Fowell Walton, of Sarratt Hall, Hertfordshire, for improvements in obtaining impressions from lithographic stones or plates.
1806. John Reed Hill, of Princes-street, Lambeth, for improvements in machinery for pulverizing metallic ores or other similarly hard substances.
1807. John Pretty Clarke, of Leicester, for improvements in the manufacture of reels for reeling of cotton, linen, thread, silk, or other fibrous material.
1808. Thomas Webster Rammell, of Trafalgar-square, for improvements in stoves and fire-places.
1809. William Edward Newton, of the Office for Patents, 66, Chancery-lane, for improved machinery for cutting files and rasps,—being a communication.
1810. Alfred Vincent Newton, of the Office for Patents, 66, Chancery-lane, for certain improvements in direct acting marine engines,—being a communication.
1811. John Coney, of Birmingham, for an improved construction of corkscrew.
1812. Peter Armand le Comte de Fontainemoreau, of South-street, for improvements in preserving corn and other dry seed,—being a communication.
1813. Peter Armand le Comte de Fontainemoreau, of South-street, Finsbury, for an improved composition for fixing lithographs and engravings on canvas, after being transposed or reproduced by a printing-press,—being a communication.
1814. William Ker and Matthew Ker, both of Tottenham-court-road, for an improvement in the frames of expanding tables.
1816. Samuel Kershaw and James Taylor, both of Heywood, for certain improvements in carding-engines.
1817. Edward Lund, of Manchester, for improvements in cocks, valves, water-plugs, and flexible joints.
1818. François Mathieu, of Bartlett's-buildings, Holborn, for improvements in filters.
1819. William Johnson, of Lincoln's-inn-fields, for improvements in moulding or shaping articles of vulcanized caoutchouc,—being a communication.
1820. William Johnson, of Lincoln's-inn-fields, for improvements in the manufacture of hat bodies,—being a communication.

*The above bear date August 18th.*

1821. William Fox and William Henry Fox, of Compton-street, for improvements in furnaces, to facilitate the combustion of smoke.

1822. Charles O'Neill, of Liverpool, for improvements in the mode or method of fitting-up or fixing the berths in emigrant ships or other vessels.
1824. Joseph Barrows, of Handsworth, for a new or improved instrument to be used in cutting loaves of bread and other articles of food.
1825. Nehemiah Brough, of Birmingham, for a new or improved dress-fastening.
1826. James Hodgson, of Sweeting-street, Liverpool, for improvements in the construction of iron vessels.
1827. James Allen, of North-street, Aberdeen, and James Taylor, of the same place, for improvements in the construction of rotatory engines.
1828. George Thomas Smartt, of Doncaster, for economizing the use of grease, oil, or other lubricating articles in axle-boxes.
1829. George Newton Lamb, of Saint Helen's, Lancashire, for improvements in the manufacture of Portland cement.
1830. William Vitruvius Greenwood and John Saxby, both of Brighton, for improvements in signal-lamps.
1831. James Worrall, jun., of Salford, for improvements in the method of cutting fustians, cotton velvets, and other piled goods or fabrics.

*The above bear date August 19th.*

1832. Robert Brisco, of Low Mill House, St. Bees, Cumberland, and Peter Swires Horsman, of St. John's, Beckermeth, in the same county, for improved machinery for preparing flax, hemp, and other fibrous substances for spinning.
1833. Tristram Shanty Simpson, of Saint Ann's-place, Limehouse, for improvements in sashes.
1834. Thomas Miller, of Fairfield-place, Stepney, for improvements in apparatus for raising coals and other weights from the holds of ships and other places.
1835. William Henry Smith, of Philadelphia, Henry Bessemer, of Baxter House, St. Pancras, and Robert Longsdon, of Hornsey-lane, for improvements in the manufacture and treatment of slag and vitreous substances, and the combination of other substances therewith.
1836. Stopford Thomas Jones, of Union-court, Old Broad-street, for further improvements to reduce and wash minerals to extract metal therefrom, especially gold.
1837. John Grist, of Islington, for improvements in machinery for the manufacture of casks, barrels, and other similar articles.
1838. Robert Barlow Cooley, of Nottingham, for an improvement in gloves.

*The above bear date August 21st.*

1840. Augustin Jacquelin, of Paris, for certain improvements in the manufacture of gas for illumination and heat.

1841. William Johnson, of Lincoln's-inn-fields, for improvements in the manufacture of carding apparatus, for the preparation of fibrous materials,—being a communication.
1842. William Hunter Meriwether, of Morley's Hotel, Strand, for improvements in the construction of fences and hurdles.
1843. Robert Benton, of Saltley Hall, Birmingham, for improvements in marine and railway telegraphs.
1844. John Buchanan, of Leamington Priors, for improvements in marine engines.
1845. William Hunter Meriwether, of Morley's Hotel, Strand, for improvements in producing surfaces for lying, reclining, or sitting upon.
1846. James Lamb Hancock, of Milford Haven, for an improved pneumatic safety inkstand.
1847. William Edward Newton, of the Office for Patents, 66, Chancery-lane, for certain improvements in carding-engines, being a communication.
1848. Charles Blunt, of Sydenham, and Joseph John William Watson, of Wandsworth, for an improved description of artificial fuel.

*The above bear date August 22nd.*

1849. William Shepherd Smith, of Charlotte-street, Fitzroy-square, for improvements in piano-fortes.
1851. John Norton, of Cork, for an igniter or apparatus for igniting explosive and combustible materials.
1853. Matthew Curtis, of Manchester, William Henry Rhodes, of Gorton, Lancashire, and John Wain, of Greenacres Moor, Oldham, for improvements in certain machines for spinning and doubling cotton and other fibrous substances.
1854. Aristide Balthazard Bérard, of Paris, for certain improvements in the manufacture of gas coke and other products from coal, and in apparatus for that purpose.
1855. Peter Fairbairn and Thomas Greenwood, both of Leeds, for improvements in machinery for preparing to be spun, cotton, wool, flax, silk, and other fibrous materials.
1856. Julien Louis Pierre Jean Baptiste Hector Bouvet, of Paris, for an improved suction apparatus for pumping and exhausting purposes.

*The above bear date August 23rd.*

1857. Henry Frost, of Sheffield, for improvements in furnaces or fire-places for steam generators, and other purposes.
1858. Willam Brooke, of Martin's-lane, Cannon-street, for consuming smoke, and condensing noxious and other gases and vapours, and converting the products thereof to valuable purposes, which now escape to the injury of the animal and vegetable life.
1859. John Horrocks, of Pilkington, for certain improvements in pin cops, or pin bobbins, or spools for weaving.

1860. Thomas Hayter, of the King's Head, Southwark, for improvements in apparatus for holding straps for sharpening razors.  
 1861. Hector Grand de Châteauneuf, of Paris, for certain improvements in the process and apparatus for washing.  
 1862. Peter Armand Le Comte de Fontainemoreau, of South-street, for certain improvements in apparatus for illuminating, —being a communication.

*The above bear date August 24th.*

1864. Robert Beck Froggart, of Manchester, for improvements in the mode or method of purifying, clarifying, and reducing the specific gravity of oils or fatty bodies, and also of clarifying fermented liquids with the machinery or apparatus used in the said processes.  
 1865. Joseph Henry Tuck, of Pall-mall, for improvements in packing for pistons, piston-rods, valves, and other uses.  
 1866. James Thomas Skinner, of Georgiana-street, Camden Town, for improved apparatus for rendering the shunts or points of railways self-acting; applicable also to the working of railway signals.  
 1868. Henry Bessemer, of Baxter House, Old Saint Pancras-road, for improvements in guns for throwing projectiles for naval and military purposes.  
 1869. William Woodcock, of the Earls-court Brewery, Brompton, for an improvement in the construction of furnaces.

*The above bear date August 25th.*

1870. George Wall, of Manchester, for improvements in machinery or apparatus for the manufacture of pottery.  
 1871. Henry Davey, of Kent-street, Southwark, for consuming smoke in furnaces.  
 1872. John Gedge, of Wellington-street South, for improvements in boring instruments, known as augers, bits, or gimlets, —being a communication.  
 1873. William Smith and Thomas Phillips, of Snow Hill, for a new mode of constructing and connecting pipes or tubes for gas, water, or steam purposes.  
 1874. Coërentin Marie Perron de Kermoal, of Paris, for an improved system for preserving and transporting animal and other alimentary substances.  
 1876. Henry Francis, of the Strand, for a machine for scutching flax, hemp, and other like fibrous materials.  
 1877. Peter Fairbairn, of Leeds, and Robert Dempster, of Bessbrook, near Newry, Ireland, for improvements in machinery for carding, drawing, and spinning tow and tow waste.

*The above bear date August 26th.*

1878. Auguste Antoine Legras, of Paris, for an improved apparatus for regulating the level or flow of liquids.

1879. Thomas Carr, of Liverpool, for improvements in steering apparatus.
1880. Robert Mc Connel, of Glasgow, for improvements in shutters for doors and windows.
1881. James Donovan, of Church-path, Hackney, for an improved mode of constructing steam-boiler and other furnaces for the purpose of consuming smoke.
1882. John Kirkham, of Tonbridge-place, New-road, and Thomas Nesham Kirkham, of Edith-grove, West Brompton, for improvements in the process of manufacturing and purifying gases for lighting and heating, and in apparatus to be employed therein.
1883. George Burch, of Waltham-cross, for improvements in the manufacture of pulp.
1884. John Gray, of Strand-street, Liverpool, for improvements in the mariner's compass.

*The above bear date August 28th.*

1885. Isaiah James Machin, of St. Giles in the Fields, for improvements in cutting screws.
1886. James Lamb Hancock, of Milford Haven, for improvements in machinery for draining land.
1887. Joseph Burrige, of Great Portland-street, for improvements in apparatus for closing fire-places.
1888. John Gray, of Dublin, for a self-acting flushing apparatus, which may be arranged for registering the quantity of water or other liquid flowing through it.
1889. Thomas Mc Nally, of William-street, Blackfriars, for improvements applicable to window-sashes or shutters.
1890. Louis Napoleon Langlois, and Jean Baptiste Clavières, both of Paris, for a new mode of constructing steam-boilers.
1891. Jean de Redon, of Paris, for a new machine for cutting or preparing wood, to be used in the manufacture of paper.
1892. John Seithen, of Wakefield-street, Brunswick-square, for improvements in the manufacture of cases or envelopes for covering bottles.
1893. John Fisher Williams, of Artillery-place West, Bunhill-row, for improvements in joining cast-iron tubes.

*The above bear date August 29th.*

1895. Jules Mathieu, of Paris, for improvements in pumps,—being a communication.
1896. William Campion, of Nottingham, for improvements in the manufacture of warp fabrics.
1898. William Nimmo, of Pendleton, for improvements in machinery or apparatus for producing ornamental woven fabrics.
1900. John Seithen, of Wakefield-street, Brunswick-square, for improvements in apparatus for cutting squares of cork.

1901. William Symington, of King William-street, for improvements in apparatus for heating air by means of steam.

*The above bear date August 30th.*

1902. Michel Napoleon Illakowicz, of Maddox-street, for improvements in picture-frames.

1903. Robert Christopher Witty, of Torriano Avenue, Camden-road Villas, for improvements in illumination by means of artificial light.

1905. Julian Bernard, of Club Chambers, Regent-street, for improvements in the manufacture of combs.

1906. Eugène König, of Rue du Temple, Paris, for improvements in manumotive carriages.

1907. William Campion, of Nottingham, for improvements in rotary knitting machinery.

1908. John Macmillan Dunlop, of Manchester, for improvements in machinery or apparatus for preparing, cleaning, and cutting India-rubber and gutta-percha,—being partly a communication.

*The above bear date August 31st.*

1910. Peter Armand le Comte de Fontainemoreau, of South-street, for an improved soap, to which he gives the name of saponitoline,—being a communication.

1911. Peter Armand le Comte de Fontainemoreau, of South-street, for certain improvements in apparatus for retarding and stopping railway carriages,—being a communication.

1912. Peter Armand le Comte de Fontainemoreau, of South-street, for an improved process of manufacturing alcohol from the stem and ear of maize,—being a communication.

1913. Marie Louise Lindheim, of Paris, for certain improvements in the manufacture of bonnets or caps.

1914. James Danks, of Birmingham, for an improvement or improvements in inkatands; which improvement or improvements may also be applied to the stoppers of bottles, the packing of pistons, and other like purposes.

*The above bear date September 1st.*

1915. Joseph Worthington, of Manchester, for improvements in counters, or fittings of shops, warehouses, and offices, for arranging, preserving, and exhibiting articles therein.

1916. Hezekiah Edwards and James Hodson, both of Islington, for improvements in the formation of envelopes.

1917. George Lewis, of High Cross-street, Leicester, for improvements in the construction of locks.

1918. William Finlay, of Aylesford, for improvements in machinery for manufacturing bricks and tiles.

1919. Henry Bernoulli Barlow, of Manchester, for improvements in machinery for cleaning cotton and other fibrous materials,—being a communication.

1920. Nicholas Callan, of Maynooth College, for improvements in certain galvanic batteries.
1921. Pierre André Decoster, of Paris, for certain improvements in extracting the saccharine parts of the sugar reeds, and of other sacchariferous substances.
1922. Thomas Craddock, of Portway Foundry, Wednesbury, for certain improvements in the steam-engine.
1923. Richard Dugdale Kay, of Accrington, for improvements in machine printing.
1924. Alfred Vincent Newton, of the Office for Patents, 66, Chancery-lane, for improvements in machinery applicable to the cutting, dressing, and polishing of stone,—being a communication.

*The above bear date September 2nd.*

1925. Edward Alfred Cowper, of Great George-street, Westminster, for improvements in self-feeding furnaces, and in machinery for working such furnaces.
1926. John Fish, of Livesey, near Blackburn, and John Thompson, of Witton, near Blackburn, for improvements in the mode or method of picking warps.
1928. George Mackay Miller, of Inchicore, Dublin, for improvements in axle-boxes and parts working in connection with axles of carriages and other vehicles in use upon railways.
1929. John Lockhart White, Henry Henderson, and James Couper, sen., all of Glasgow, for improvements in water-closets.
1930. William Hill, of Congleton, for certain improvements in doubling or twisting net or raw silks.
1931. Ellis Rowland and James Rowland, both of Manchester, for improvements in coupling or connecting-links for railway carriages or other such purposes.
1932. William Haslett Mitchel, of Brooklyn, for improvements in means for distributing type.
1933. Samuel Mayer, and William Bush, both of Bristol, for improvements in reducing flint and other substances; rendering them suitable for the manufacture of porcelain and other earthenware articles.
1934. Francis Alfred Skidmore, of Coventry, and Joseph Bolton, of the same place, for improvements in the manufacture of cast-iron pipes.
1935. John William Sloughgrove and James Henry Wheatley, both of Windsor-street, Islington, for improvements in furnaces and ovens to promote the consumption of smoke.

*The above bear date September 4th.*

1937. William Brownfoot, of Leeds, for a new or improved instrument or apparatus for raising, lowering, and adjusting Venetian blinds.
1938. François Xavier Alexis Fauvelle, of Paris, for certain improvements in cleaning dressing combs,—being a communication.



1939. Henry Trappes, of Manchester, for a process for the preparation of leather, to be used in the manufacture of a new flock, and for the manufacture of the same, to be used and applied in lieu of flock made from pounded or ground wool and woollen materials, heretofore commonly used in the manufacture of painted, printed, and dyed decorating papers, carpets, oil-cloths, and other things; and also to be used as a paste or pulp for the manufacture of all kinds of paper, parchment, and pasteboard, of toys, of ornamental and other picture frames, of mouldings, architectural and sculptural ornaments, and other things,—being a communication.
1940. Samuel Stocker, of Brighton, for certain coverings for various parts of the human body with a view to the preservation of health.
1941. William Barnes, of Royal Exchange-buildings, for improvements in fastening rails of railways.
1942. John Henry Pape, of Paris, for improvements in wind musical instruments.
1943. Isaac Pim Trimble, of New York, for improvements in regulating the temperature in conservatories and other apartments, or in ventilating the same.
1944. John Henry Pape, of Paris, for improvements in pianofortes.

*The above bear date September 5th.*

1948. William Newbould, of Derby, for improvements in the manufacture of busks for stays.—[*Dated September 6th.*]
1950. George Printy Wheeler, of Bellevue-place, Mile-End-road, and Samuel Broomhead, Gent., of Holford-square, Pentonville, for the production of new fibrous materials capable of and suited for the manufacturing of string, rope, matting, and various fabrics, with or without the combination of cotton, wool, or flax, or for pulp for the manufacturing of paper, papier-maché, millboard, &c.
1952. William Johnson, of Lincoln's-inn-fields, for improvements in coating iron and steel wire with other metals or alloys,—being a communication.
1954. Robert Adams, of King William-street, for improvements in breech loading fire-arms,—being a communication.

*The above bear date September 7th.*

1956. James Burns, of Manchester, for improvements in ventilating ships.
1958. John Jones, of Sheffield, for improvements in metal dinner and dessert forks.
1962. Robert Macallister, of Glasgow, for an improvement in fitting or applying screw propellers to ships and vessels.
1964. Edwin Travis, of Oldham, for improvements in apparatus for measuring water and other fluids.

1966. Julian Bernard, of Club Chambers, Regent-street, for improvements in the manufacture of boots and shoes or other coverings for the feet.
1968. Benjamin Hustwayte, of Hockley-street, Homerton, for an improved construction of metal roofing.

*The above bear date September 8th.*

1970. Achille Guyardin, of Paris, for the use of a certain fibrous matter for the manufacture of paper and pasteboard.
1972. William Bowler, of Southwark Bridge-road, for improvements in hats and other coverings for the head.
1974. Thomas Clowes, of Beverley, for improvements in muzzles for horses, or apparatus to prevent horses from biting or sucking their cribs or mangers.

*The above bear date September 9th.*

1976. John Rigby, of Dublin, for improvements in fire-arms and guns, and in waddings to be used therewith.
1978. John Norton, of Cork, for improvements in the manufacture of ropes, bands, and cordage.
1980. Samuel Szontagh, of Paris, for improvements in sewing-machines.

*The above bear date September 11th.*

1982. Martin Billing, of Birmingham, for improvements in manufacturing and ornamenting castors for furniture.
1986. Edmund Morewood and George Rogers, both of Enfield, for improvements in baths, or receptacles for melting and containing certain metals for the purpose of coating other metals.

*The above bear date September 12th.*

1988. William Nash, of Islington, and John Jewell, of the same place, for improvements in window-sashes and frames.
1990. Auguste Edouard Loradoux Belford, of Castle-street, Holborn, for improvements in electro-magnetic clocks,—being a communication.
1992. Anguish Honour Augustus Durant, of Tong Castle, Salop, for a new or improved axle and axle-box, to be called the anateiros or antifriction axle; which said axle and axle-box may be used for wheel carriages and for a shaft or axle and bearing for machinery in general.
1994. Henry Crosley, of Camberwell-grove, for improvements in the manufacture of paper, millboard, and felt, from materials not hitherto so used.

*The above bear date September 13th.*

---

**New Patents.***Sealed under Patent Law Amendment Act, 1853.*

- |   |   |
|---|---|
| 449. B. J. Green.                               | 648. William Dantec.                                |
| 461. George Collier.                            | 649. P. M. Parsons.                                 |
| 469. Frederick Westbrook.                       | 653. John Bird, jun.                                |
| 470. E. Chappuis.                               | 655. E. Esnouf C. Mauger, jun.,<br>and G. W. Lewis. |
| 475. R. A. Brooman.                             | 656. F. Loret Vermeersch.                           |
| 476. John Morrell.                              | 657. J. Horton and R. J. Polglase.                  |
| 477. L. A. Pallegoix and A. L.<br>Bellange.     | 658. C. A. B. Chenot.                               |
| 478. Theobald Denny.                            | 660. John Longbottom.                               |
| 480. E. & J. Marsden.                           | 661. Joseph Perkins.                                |
| 482. J. H. Rehé.                                | 665. W. Stevens & W. Stevens, jr.                   |
| 491. J. S. Holbeche.                            | 667. James Hansor.                                  |
| 507. John Parry, jun.                           | 668. John Polson.                                   |
| 509. H. & J. Ellis.                             | 669. R. Roberts and G. Coppock.                     |
| 510. A. Barclay.                                | 672. John Sheringham.                               |
| 511. Andrew Barclay.                            | 674. George Sterry.                                 |
| 519. John Nicholson.                            | 676. T. S. Watson.                                  |
| 524. W. Vaughan & J. Scattergood.               | 677. J. Healey, J. Foster, & J. Lowe.               |
| 526. Charles Nightingale.                       | 678. J. H. Robinson.                                |
| 527. Charles De Bergue.                         | 685. L. Whitaker & D. Ashworth.                     |
| 528. Richard Madeley.                           | 692. R. Doidge and John Cloves.                     |
| 533. David Barr.                                | 693. B. Fothergill and W. Weild.                    |
| 538. T. H. De Nivelles.                         | 697. E. Bagot.                                      |
| 550. George Beardsley.                          | 698. J. Lochhead & R. Passenger.                    |
| 551. Richard Boyell.                            | 699. James Robertson.                               |
| 558. William Warne.                             | 704. George Beaumont.                               |
| 562. James Smith.                               | 708. Frederick Phillips.                            |
| 565. W. B. Johnson.                             | 717. William Hähner.                                |
| 567. William Young.                             | 719. William Hähner.                                |
| 574. T. Mosely.                                 | 721. J. H. Johnson.                                 |
| 583. D. P. Lefevre.                             | 725. J. P. Lucevilliard.                            |
| 584. Zephirin Boitteux.                         | 734. William Simpson.                               |
| 586. John Patterson.                            | 741. A. A. de Reginald Hely.                        |
| 597. John Buchanan.                             | 745. F. S. Thomas.                                  |
| 598. L. Whitaker, J. Diggle, and<br>G. Howarth. | 757. Thomas Scott.                                  |
| 603. Edward Hæffely.                            | 760. William Ashdown.                               |
| 613. James Woodford.                            | 763. G. Devincenzi.                                 |
| 614. R. A. Brooman.                             | 767. John Swarbrick.                                |
| 615. P. A. le Comte de Fontaine-<br>moreau.     | 771. B. Samuelson.                                  |
| 617. Thomas Kaye.                               | 777. J. H. Glassford.                               |
| 619. J. P. Oates.                               | 778. Henry Blatter.                                 |
| 620. L. Whitaker and G. Lyons.                  | 782. James Howden.                                  |
| 627. M. Binns and J. Pollard.                   | 783. C. Bekaert.                                    |
| 629. Robert Weare.                              | 788. John Weston.                                   |
| 630. D. Bethune.                                | 791. C. De Bergue.                                  |
| 635. John Gerard.                               | 792. Joseph Nash.                                   |
| 636. William Holt.                              | 793. S. O'Regan.                                    |
| 641. G. H. Barth.                               | 805. A. Tylor.                                      |
| 644. G. W. Reynolds.                            | 811. J. Jopling.                                    |
| 646. John Hick.                                 | 812. W. H. Bentley.                                 |
|   | 813. Thomas Wood.                                   |
|   | 814. John Rankin.                                   |

815. H. B. Condry.  
 835. L. M. Trouble.  
 840. F. L. Bauwens.  
 841. W. L. Baker.  
 842. R. A. Brooman.  
 855. W. H. James.  
 868. G. Devincenzi.  
 877. F. Barnett.  
 888. S. J. Healey.  
 908. R. Richardson.  
 913. W. Johnson.  
 927. T. F. Finch.  
 929. R. Galloway.  
 935. M. Poole.  
 942. W. Blackwood.  
 975. James Fenton.  
 996. M. Poole.  
 1031. T. Lemielle.  
 1040. P. A. Sparre.  
 1043. W. Williams.  
 1135. L. Sautter.  
 1136. H. S. Rogers.  
 1164. Joseph Harrison.  
 1166. E. C. Mantrand.  
 1167. L. M. F. Doyere.  
 1181. James Murdoch.  
 1186. John Evans.  
 1189. William Northen.  
 1202. John McFarlane.  
 1208. C. C. E. Minié.  
 1212. David Duncan.  
 1234. P. A. le Comte de Fontaine-  
       moreau.  
 1237. W. E. Newton.  
 1252. S. S. Alison.  
 1270. Thomas Richardson.  
 1299. T. Wilson and J. Hadley.  
 1300. J. Kite.  
 1303. J. D. M. Stirling.  
 1345. A. Stephen and A. Pirnie.  
 1357. H. V. Physick.  
 1359. O. R. Chase.  
 1361. W. E. Newton.  
 1368. G. Simpson.  
 1369. J. M. Blashfield.  
 1372. A. E. L. Bellford.  
 1374. A. E. L. Bellford.  
 1387. J. Wield.  
 1391. R. Garrett, jun.  
 1399. J. Thomson.  
 1403. E. Hubner.  
 1413. C. H. Collette.  
 1417. C. Iles.  
 1420. P. A. Le Comte de Fontaine-  
       moreau.  
 1425. T. Schloesing.  
 1428. C. S. Sperry.  
 1433. D. T. Shears.  
 1437. H. G. Gray.  
 1438. J. Mc Gaffin.  
 1439. T. Slater and J. Tall.  
 1440. J. H. Johnson.  
 1444. J. H. Johnson.  
 1446. George Hutchison.  
 1448. J. K. Milne.  
 1451. W. Greenshields.  
 1452. William Balk.  
 1460. Thomas Haines.  
 1461. J. Mc Gaffin.  
 1465. R. Garrett & R. Garrett, jun.  
 1480. John Glasgow.  
 1482. O. Avery.  
 1489. J. E. Mc Connell.  
 1495. George and William Beard.  
 1510. S. M. Saxby.  
 1512. G. A. Biddell.  
 1513. P. F. Aerts.  
 1515. T. F. Henley.  
 1520. William Eassie.  
 1524. O. Maggs.  
 1549. J. Mc Gaffin.  
 1550. J. Mc Gaffin.  
 1563. M. F. Wagstaffe and J. W.  
       Perkins.  
 1564. Joseph Spires.  
 1576. R. Hornsby.  
 1577. A. E. L. Bellford.  
 1607. A. E. L. Bellford.  
 1636. John Mc Gaffin.  
 1644. E. A. Pontifex & C. Glassford.  
 1671. P. G. Harris.  
 1673. E. Burke.  
 1688. T. R. Bridson.

\*\* For the full titles of these Patents, the reader is referred to the  
 corresponding numbers in the List of Grants of Provisional Protections.

CELESTIAL PHENOMENA FOR OCTOBER, 1854.

D. H. M.		D. H. M.	
1	Clock after the ☉ 10m. 17s.	15	Pallas, R. A., 19h. 6m. dec. 4.
—	☽ rises 4h. 17m. A.	—	33. N.
—	☽ passes mer. 8h. 11m.	—	Ceres, R. A., 20h. 41m. dec. 29.
—	☽ sets Morn.	—	38. S.
14	☽ in Perigee.	—	Jupiter, R. A., 19h. 23m. dec.
2 7 49	Juno in conj. with ♃ diff. of dec.	—	22. 33. S.
	6. 38. N.	—	Saturn, R. A., 4h. 58m. dec. 20.
3 8 2	♃'s first sat. will em.	—	54. N.
5	Clock after the ☉ 11m. 31s.	—	Uranus, R. A., 2h. 53m. dec. 16.
—	☽ rises 5h. 38m. A.	—	9. N.
—	☽ passes mer. 11h. 38m.	—	Mercury passes mer. 1h. 2m.
—	☽ sets 4h. 33m. M.	—	Venus passes mer. 22h. 54m.
6 7 37	Ecliptic oppo. or ☉ full moon.	—	Mars passes mer. 2h. 30m.
8 7	♄ in conj. with the ☽ diff. of dec.	—	Jupiter passes mer. 5h. 48m.
	0. 14. N.	—	Saturn passes mer. 15h. 21m.
18 3	♃ in Aphelion.	—	Uranus passes mer. 13h. 16m.
9	Pallas in Aphelion.	19 6 22	♃'s first sat. will em.
10	Clock after the ☉ 12m. 55s.	20	Clock after the ☉ 15m. 6s.
—	☽ rises 7h. 9m. A.	—	☽ rises 4h. 29m. M.
—	☽ passes mer. 2h. 48m. M.	—	☽ passes mer. 10h. 44m. M.
—	☽ sets 11h. 9m.	—	☽ sets 4h. 43m. A.
9 58	♃'s first sat. will em.	6 3	♀ in conj. with the ☽ diff. of dec.
11	Ocul. 189 Tauri, im. 14h. 37m.		2. 1. S.
	em. 15h. 55m.	8 0	Juno in conj. with the ☉
3 51	Pallas in ☐ with the ☉	21 9 25	Ecliptic conj. or ● new moon.
22 35	Vesta in conj. with ♃ diff. of	23 3 36	♃ in conj. with the ☽ diff. of
	dec. 6. 13. N.		dec. 2. 41. S.
12 3 33	♃ in ☐ with the ☉	24 10 29	♄ in conj. with the ☽ diff. of dec.
13 21	☽ in Apogee.		0. 41. N.
14 1 43	☽ in ☐ or last quarter	25	Clock after the ☉ 15m. 48s.
5 20	♀ greatest hel. lat. N.	—	☽ rises 11h. 21m. M.
15	Clock after the ☉ 14m. 8s.	—	☽ passes mer. 3h. 1m. A.
—	☽ rises 11h. 34m. A.	—	☽ sets 6h. 36m.
—	☽ passes mer. 7h. 0m. M.	5 0	♃'s third sat. will em.
—	☽ sets 3h. 22m. A.	26 8 17	♃'s first sat. will em.
—	Mercury, R. A., 14h. 37m. dec.	9	☽ in Perigee.
—	17. 22. S.	27 5 39	♃ in conj. with the ☽ diff. of dec.
—	Venus, R. A., 12h. 28m. dec. 1.		4. 0. N.
—	28. S.	28 7 4	☽ in ☐ or first quarter.
—	Mars, R. A., 16h. 4m. dec. 21.	9 19	♃ greatest elong. 23. 38. E.
—	43. S.	29 4 3	♃ greatest hel. lat. S.
—	Vesta, R. A., 14h. 27m. dec. 10.	30 13 42	Ceres in ☐ with the ☉
—	5. S.	31 7 4	♃'s second sat. will em.
—	Juno, R. A., 13h. 44m. dec. 4.		
	26. S.		

J. LEWTHWAITE, Rotherhithe.

THE  
LONDON JOURNAL,  
AND  
REPERTORY  
OF  
Arts, Sciences, and Manufactures,

---

CONJOINED SERIES.

---

No. CCLXXV.

---

---

RECENT PATENTS.

To THOMAS WHITEHEAD, of Leeds, in the county of York, machine and tool-maker, for improvements in machinery for preparing, combing, drawing, and spinning wool, flax, cotton, silk, and other fibrous substances.—[Sealed 7th April, 1854.]

THIS invention relates, first, to the application of a novel construction of comb to drawing, preparing, and combing-machinery, to be used in lieu of the ordinary gill-pins of such machinery. The combs employed for this purpose are formed from plates of metal, or horn, or bone, natural or factitious,—teeth being cut on one edge thereof in the ordinary manner of cutting comb-teeth. These combs are attached to gill-bars or fallers, or to rollers, to form porcupine rollers, or otherwise, where they may be advantageously applied.

In Plate IX., figs. 1, shew, in front and end elevation, a faller, constructed according to this invention; and figs. 2, a front and end elevation of a passing-comb. It will be understood that, according to the use to which the combs are to be applied, they will consist of one plate, or of two, three, or more plates attached together, as shewn in the end view, figs. 2.

This invention relates, secondly, to the employment in combing-machinery of convex fallers, nippers, and carrying combs in conjunction with circular travelling or passing-combs, provided with radial pins at their periphery,—the object being to make the delivery of the fibres from the nippers

to the passing or travelling-comb more equal than heretofore ; and also to avoid the necessity for bending the carrying or taking-comb when it comes to the nippers to receive the fibres therefrom. Figs. 3, represent, in side and end view, a gill or faller constructed according to this part of the invention ; figs. 4, represent, in elevation and cross section, the nippers for receiving the fibres, under operation, from the convex faller ; and figs. 5, shew, in front and side elevation, the carrying or taking-comb which transfers the fibres from the nippers to the pins or teeth of the circular travelling or passing-comb, from which they are removed in a combed or drawn state by the ordinary stripping or drawing-rollers. Figs. 6, represent, in side and edge views, a circular travelling-comb, which is provided with pins or teeth on its periphery. It will be understood that the curve of the gills, nippers, and taking-comb will correspond to a segment of the circular comb in combination with which they are to be employed, whatever diameter that comb may be ; and that, by this arrangement, the taking-comb will take up the fibres from the nippers, without changing its curved form (as in Lister's combing-machine), to suit the flat face of the nippers, and transfer the fibres in an even and uniform manner to the circular comb ; whereby the lapping of the fibres round the comb-pins, and the consequent formation of noils or knots, is avoided ; which inconveniences are due to the ordinary filling or transferring-comb laying some of the fibres too far over the teeth of the combs.

This invention relates, thirdly, to a novel mode of applying rotary gill-cylinders or porcupine-rollers to the combing of fibrous materials,—the object being to produce a simple and efficient combing-machine. Fig. 7, represents, in sectional elevation, so much of a combing-machine as will serve to explain the improved mode of operating with gill or porcupine-rollers. These rollers are shewn at *a, a*, as arranged in pairs, and mounted in vibrating frames *b, b*, on opposite sides of the central passing-comb. At their lower ends these frames carry friction-bowles, which bear upon rotating cams *c, c*, keyed to their respective shafts *d, d* ; which shafts have their bearings in the main framing. Connected to the shafts *d, d*, and capable of rocking thereon, are guide-rods *e*, which respectively enter grooves in the frames *b, b*, for the purpose of guiding them in their upward and downward movements ; which movements are produced by the rotation of the cams *c*. The frames *b*, are severally connected by rods to a rotating crank-arm *f* ; and motion is given to these crank-arms for

the purpose of rocking the frames *b*, and causing them alternately to approach to and recede from a passing comb *g*, of any suitable construction, set in the middle of the machine. The dotted circles represent the gearing for transmitting motion from one of the shafts *d*, (which is the main driving-shaft) to the other, and to the axles of the crank-arms. Immediately above each gill-roller *a*, and carried by the frame *b*, is a pair of feed-rollers *h*, which receive the fibre to be combed from a ball of sliver or roving *i*, set above them, and conduct it to the gill-roller beneath. This ball of sliver is also carried by the vibrating frame *b*. Each gill-roller is provided with a curved case or shield, which partially surrounds it, and assists in laying the fibres, which are carried up by the pins of the gill-roller, on to the passing-comb. These shields may, however, if thought desirable, be dispensed with. Rotary motion may be imparted to the feed-rollers *h*, and to the gill or porcupine-rollers of each frame *b*, from the shafts *d*, by the following means:—On each shaft *d*, is a finger *i*; which, by striking, in its rotation, against the pins of a stop-wheel *k*, keyed to a shaft *l*, carried by the frames *b*, will impart an intermittent axial motion to the shaft *l*. If then this shaft is provided with a worm, as at *m*, gearing into a worm-wheel *n*, on the axle of the gill or porcupine-roller, an intermittent axial motion will be communicated to that roller. A spur-wheel, on the axle of the gill-roller *a*, gearing into a spur-pinion on the axle of one of the feed-rollers *h*, will transmit rotary motion to the feed-rollers, and thus the sliver will be drawn down and fed on to the gill-roller.

The action of the machine is as follows:—Rotary motion being given to the main driving-shaft, the cams *c*, are caused to rotate and alternately raise and depress their respective frames, by acting on the bowles provided at the lower end of the frames. When a frame is raised to its highest position by its cam, its crank *f*, will cause it to approach the passing-comb. In the meanwhile the gill-roller will have drawn down and passed out from its case a portion of sliver, which, by the forward movement of the frame, will now be laid on to the passing-comb *g*. The brush *o*, which is carried by a rocking arm *p*, actuated by a cam on the axle of one of the crank-arms *f*, will next descend and press the fibres between the teeth of the comb *g*; after which the frame *b*, will make its return vibration, and draw back the gill-roller from the passing-comb; in the teeth of which, the fibres, which were laid on the comb, will be left. The gill-frame, on the opposite side of the machine, will, simultaneously with the re-



tiring of this frame, approach the passing-comb and feed it in like manner; and thus the operation will proceed continuously,—the passing-comb receiving, as is well understood, an intermittent progressive motion; whereby the fibres, with which it is charged, are carried forward to the strippers or drawing-off rollers, and empty pins come up in a line with the gill-rollers to be charged with partially-combed sliver.

From the above description it will be understood that this part of the invention is confined to filling the teeth of the passing-comb with partially-combed fibres; and that any suitable arrangement of passing-comb and drawing-off rollers or strippers may be employed in connection with the invention. Thus, if, for example, it is preferred to use, as a passing-comb, a circular comb, rotating in a horizontal plane, the periphery of the gill or porcupine-rollers must take a curve corresponding to the line of pins or teeth of the comb. The patentee proposes to employ, in this machine, gill or porcupine-rollers of the ordinary description, or to construct them according to the first part of the invention.

This invention relates, lastly, to the introduction, into hot-water spinning-frames, of a hollow carrying-roller, for imparting moisture to the roving, as it passes from the holding to the drawing-rollers. Fig. 8, represents, in vertical section, so much of an ordinary hot-water spinning-frame as will serve to explain the mode of carrying out this part of the improvements. *a, a*, are the ordinary roving-bobbins,—the rovings from which are conducted down to and passed through the trough of liquid *b*; they then pass between the holding-rollers *c, c*, and over a hollow perforated carrying-roller *d*, which is supplied with liquid from the trough *b*; or it may be separately heated by steam or otherwise, as may be found practicable. The rovings thence pass between the drawing-rollers *e*, by which they are conducted, in an elongated or attenuated state, to the flyer *f*, to be spun into yarn. The above-described arrangement will allow of the drawing out of the fibres to a finer sliver or yarn than by the ordinary construction of drawing and spinning-machinery.

The patentee claims, First,—the mode described under the first head of this invention of constructing combs, to be used in lieu of gill-pins. Secondly,—the means above described with reference to figs. 3, 4, 5, and 6, or any mere modification thereof, for effecting the transfer of the partially-combed fibres from the screw-gill drawing-head to the travelling or passing-comb. Thirdly,—the arrangement of combing machinery shewn at fig. 7, wherein rotary-gills or porcupine-

rollers, mounted on vibrating frames, are employed for straightening the fibres, and afterwards transferring them to a passing-comb. And, Lastly,—the application to hot-water spinning-frames of hollow carrying-rollers, for imparting moisture to the roving just previously to its entering the nip of the drawing-rollers.

---

*To HENRY BEAUMONT LEESON, of Greenwich, in the county of Kent, M.D., for improvements in gas-burners.*—[Sealed 11th January, 1854.]

THE object of this invention is to obtain a more convenient means of combining air with gas in a gas-burner. For this purpose the burner is constructed with numerous small passages at the upper part, where the gas mixed with air is burned. The burner is hollow, and the lower part is open, but capable of being closed more or less by a conical or other suitable form of valve on the tube which introduces the gas into the hollow chamber of the burner; and the burner is made capable, by means of a screw, of rising or falling, so as to regulate the quantity of air which is permitted to flow into the hollow chamber of the burner.

The patentee remarks that when gas is burned for the purpose of producing light, it is necessary that a certain amount of its constituent carbon should remain unburnt; that is, the whole of the carbon must not enter into combination with oxygen. Imperfect combustion and a limited supply of atmospheric air is therefore necessary for the purpose of illumination. When, on the contrary, the greatest amount of heat is to be obtained from the combustion of the gas, the whole of the carbon as well as other constituents must unite with oxygen, and sufficient air must be admitted for that purpose. For the purpose then of obtaining the greatest heat, just sufficient air should be admitted into the mixing chamber of the burner by the valve to remove all white light from the flame. If less than this be introduced there will be a waste of gas; if more, a waste of heat, by the cooling due to the superfluous air. Much of the economy and utility of this invention depends on the relative areas of the apertures and supplying pipes. It is found that when air is mixed with gas in sufficient quantity to insure perfect combustion, the bulk of the mixed gas is increased to about fifty times its volume, and requires, therefore, a proportionate outlet. Thus, if the apertures for the admission of the gas into the mixing chamber be one-twelfth of an inch, the jets or burners should be formed either with fifty

holes one-twelfth of an inch diameter, or with a proportionately larger number of smaller apertures. The area of pipe conducting the gas from the mixing chamber of the burner to the burner must, in this case, be about three-quarters of an inch internal diameter. If the outlets be not sufficient the gas will ignite when a light is held to the lower part of the chamber, where air is admitted; indeed, the gas in that case will frequently catch fire at this part. If, when the air-valve is fully open, the gas flame still contains a portion of white light, it shews either that too much gas has been admitted to the mixing chamber for the size of the jets or burners, and that the flow of gas must be lessened, by screwing in the plug by which the size of opening from the gas-pipe is regulated, or that a sufficient heat at the burner is wanting to insure the requisite flow of air with the gas. A single chamber about two inches diameter is supplied with gas through a hole one-twelfth of an inch in diameter, and this is sufficient to supply four or five feet of pipe drilled with holes one-sixteenth of an inch in diameter, and having about fifty holes in twenty-one inches of length: hence it is sufficient for an ordinary roasting chamber. When the gas is burnt from apertures in a tube or pipe, it will be found useful slightly to elevate the extreme portion of the pipe, which will facilitate the equal distribution of the flame.

In Plate IX., fig. 1, shews a section of a burner regulated by a conical valve; fig. 2, shews a plan of an apparatus arranged with three burners and one mixing chamber; and fig. 3, a section of the same: fig. 4, is a section of another arrangement where there is but one burner over the mixing chamber, and there is an exterior chamber, which is sometimes found convenient, for more thoroughly mixing the gas and air. It is desirable to remark, that by the peculiar combination of parts constituting this invention, all the air necessary for the combustion of the gas employed is first mixed with the gas in the mixing chamber of the burner or burners; hence the burners do not require that the lower part of the apparatus or chamber in which the burning takes place should have openings, or be open for the passage of air upwards to support combustion; and this is important, as such unnecessary air tends to cool the object to be heated. Fig. 5, shews an arrangement where the burner is a tube perforated with holes communicating with a mixing chamber, such as before referred to. In this case there is a bar to aid in keeping the apparatus or burner hot. Fig. 6, shews a plan of a circular concentric ring burner in communication with a mixing chamber; and fig. 7, shews a side view

of a series of cylindrical burners fixed to a tube and in communication with a mixing chamber. The patentee remarks that the peculiarity of this apparatus is chiefly to be found in the combination of the parts constituting the mixing chamber, and that the form of the burner may be varied. He prefers in all cases that the gas supplying tube should have but one outlet, and that the opening of such outlet should be regulated by a screw-plug, as shewn either at the top or other convenient part of the supply-tube. The shape of the mixing chamber may be varied, but the form shewn is preferred; and in each case it is made with a valve, to adjust the quantity of air passing into it. *a*, is the pipe for the introduction of gas, to be connected to the usual supply-cock; *d*, the small orifice for the exit of gas into the chamber, regulated by a screw to close or open the aperture; *b*, the chamber in which the mixture of air and gas takes place; *c*, a second chamber for the further mixing of the gas, which enters therein by holes from the chamber *b*; *e*, the valve which regulates the entrance of the air; *f*, the holes or jets where the gas is inflamed, having a button or bar of metal *g*, to raise the burner to a proper temperature.

The patentee claims the combined apparatus herein shewn and described.

---

*To JOSEPH ATKINSON, of Richmond-grove, in the county of Middlesex, engineer, for improvements in thrashing machinery.—[Sealed 27th January, 1854.]*

THIS invention relates, first, to an improved construction and arrangement of the parts of the thrashing-drum or cylinder, and also the concave in which the said drum or cylinder works; and, secondly, to a novel arrangement of parts for feeding into the machine the corn, grain, or other agricultural produce to be thrashed.

In ordinary thrashing-machines the thrashing-drum or cylinder, and also the concave in which it works, are provided with stout short pegs or pins, whereby the corn or grain is beaten or knocked out of the ear. These pegs are usually fixed in the drum and concave, and are arranged in such a manner that the pegs of the drum intersect or pass between the pegs of the concave when the former rotates.

By this means the ears of corn are rubbed between the pegs of the drum and those of the concave,—and the grain is thereby beaten out. In place of fixing these pegs or studs in the drum and concave, as heretofore, it is proposed to attach them to

rollers, which will be mounted in suitable bearings in the concave, and also in the end plates of the drum. These pegged rollers will be free to rotate on their axles,—by which arrangement of parts the thrashing operation will be effectually performed, and the straw will be delivered in a much better state than heretofore.

The improved feeding motion consists simply in the employment of an endless band or chain, provided with vertical teeth or prongs, for the purpose of carrying the corn or produce forward into the machine.

It will be evident that this endless chain or band may be made of any convenient length, so as to extend from the barn or stack to the machine.

In Plate X., fig. 1, is a transverse vertical section of the improved thrashing-machine; fig. 2, is a back view of the spike rollers, shewing the manner in which they are respectively mounted and arranged; and fig. 3, represents one of the spike rollers detached. Figs. 4, are two views of an indented ribbed disc or wheel, which may be used in place of the spiked roller shewn in fig. 3. This disc or wheel is made of metal, and has an irregular surface, with ribs projecting from it, as also notches or recesses made in its periphery.

The framing of the machine is shewn at *a*: the spiked rollers *b*, *b*, are mounted, and turn loosely upon axles *c*, *c*, arranged concentrically around the drum *d*, and having their bearings in the end plates *e*, *e*, of the machine: they may also have additional supports in some parts of their length, if found necessary. The spikes or tines of the spiked rollers *b*, *b*, are notched or otherwise made rough on their sides, as shewn at the enlarged view fig. 3, so as to act more effectually in detaching, beating, or rubbing out the grain from the ear, as the corn passes through the machine.

The feeding apparatus by which the corn is fed into the machine is shewn at *f*, *f*, fig. 1. It consists of a broad endless chain, band, or sheet of leather, or other material furnished with spikes and passed around rollers *g*, *g*, the lower one of which has a slow motion communicated to it from the shaft of the drum *d*, by means of a band or toothed gearing.

The operation of the machine is as follows:—Motion is first communicated to the main drum *d*, in the usual way. The corn to be thrashed is then laid in suitable quantities upon the travelling feeding-band *f*, *f*, which gradually carries it down into the machine, and deposits it upon the drum *d*, which, by means of its beaters *d*\*, carries it in amongst and between the spiked rollers *b*, *b*, which, together with the beaters of the cy-

linder or drum *d*, separate the grain from the straw. The spiked rollers *b, b*, being mounted loosely on their shaft or axle, are caused to revolve by friction of contact with the straw as it is driven through the machine.

Sometimes, in place of the fixed spikes shewn as adapted to the drum, the latter is furnished with spiked rollers, similar to those above described as applied to the concave,—and in that case the axles of the rollers are mounted in the end plates of the drum. As the mode of constructing and applying the spiked rollers to the drum will be similar to that above explained in reference to the concave, no further description will be necessary.

The indented ribbed wheel shewn in fig. 4, which is intended to be used in place of the spiked rollers above described, consists of a plate of metal provided at the side with a number of projecting ribs *i, i*, extending from the axle to the periphery, which is also cut out or notched, for the purpose of catching hold of the ear and drawing the corn forward.

The patentee claims the use and application to thrashing machines of rotating rollers, discs, wheels, or other analogous contrivances, provided with projecting ribs, teeth, spikes, or prongs, for the purpose of beating, rubbing out, or detaching from the ear the corn or grain contained therein, as above described.

Also the use of the travelling-band armed with spikes as above described, for the purpose of feeding the corn into the machine.

---

To JAMES TAYLOR, of Carlisle, engineer, ISAAC BROWN, of the same place, merchant and field seedsman, and JOHN BROWN, of Oxford-street, in the county of Middlesex, silk mercer, for improvements in the charring of vegetable and animal substances.—[Sealed 7th February, 1854.]

THIS invention relates to a mode of making what is usually known as peat charcoal, and drying and charring vegetable or animal substances by a continuous and economical process. The peat or other substance to be dried is passed through a heated chamber; the material being carried through upon trays, made of perforated iron plates, or a web of wire-cloth, attached to endless chains, and moved along at such a speed as will cause it to be dried in its passage through the chamber. The dry peat or other material is then put into a vertical retort, enclosed in brickwork, or a casing of segmental flags, made of well-burned fire-clay, and hooped with wrought-iron

hoops,—the heat being applied around and through the retort in any convenient manner. When once in operation such a retort is never permitted to cool down, but is kept constantly ready for action; and when the charge of material is sufficiently charred it is withdrawn at the bottom, whilst it is hot, and received into an air-tight portable vessel, to be removed to a suitable place to cool. When one charge is withdrawn another is at once put into the retort,—the heat being thus regularly kept up and the charring process going on.

In Plate IX., fig. 1, represents a longitudinal vertical section of the drying-chamber, in which the peat or other material is first dried; and fig. 2, is a vertical section of the furnace and retort, shewing also an end view into the interior of the drying-chamber, which is formed in the same building. The drying-chamber *a*, is heated by the under flue *b*, and contains an endless wire-cloth *c*. This cloth carries the newly-cut peat or other material, to be dried or partially carbonized, and is supported by the series of rollers *d*, being driven by the main end drums *e*, to which motion may be communicated by any convenient mechanical arrangement. The peat is traversed slowly through the drying-chamber,—the speed of the endless cloth being, of course, regulated according to the nature of the peat and the heat of the furnace. When properly dried the material may be discharged either at the end or sides of the chamber, whichever may be found most convenient. The subsequent process to which it is subjected is that of carbonization, which is effected by enclosing the peat, previously dried or partially carbonized, in the vertical retort *f*, which is surrounded by the brickwork of the furnace; a space being left all round for the heat and flame of the furnace to circulate. The interior of the retort is fitted with a number of vertical and horizontal tubular flues *g, g*, which open into the flue *b*, and thence into the chimney *h*, which serves both for the retorts and steam-engine, if one be employed. A curved pipe *i*, serves to carry off the gases and vapours thrown off in the charring process. This pipe dips into the hydraulic main *j*, which communicates with a condenser. The flooring *k*, which carries the hydraulic main, serves also to carry an overhead railway, for the facility of filling the retorts; a series of which may be fitted side by side, if the extent of the works should render such an arrangement necessary. The bottom of each retort is fitted with a sliding door *l*, which is actuated by a screw-spindle and lever-handle *m*. When the retort is to be discharged, a wrought-iron air-tight receiver *n*, is brought beneath it, on the lower railway *o*. This receiver is fitted with

an air-tight cover, which rests in a recess *p*, formed upon the top of the receiver itself; such recess being filled with water, or well washed and baked sand. After filling the retort, the top cover *q*, is firmly secured, and well luted. When the material, after being properly charred or carbonized, is to be discharged, the receiver *n*, is brought into the recess beneath the retort, and, the cover being removed, the sliding bottom of the retort is drawn back, and the carbonized matter is allowed to fall into the receiver, which, when full, is removed, to convey the peat to the stores for cooling. By examining the color and quantity of the vapour in the condenser, the attendant will easily perceive when the charge has been sufficiently charred. The processes of filling and emptying are carried on regularly, without allowing the retort to cool, which is thus kept constantly at work.

The patentee claims, First,—the application and use of the drying-chamber, hereinbefore described, whether the dried material be delivered at the side or end of such chamber. Second,—the application and use of retorts, with or without internal flues, for effecting the continuous and economical carbonization of animal or vegetable substances. Third,—the application and use of an air-tight receiver or carriage, in conjunction with the retort, as hereinbefore described. Fourth,—the general arrangement and construction of drying-chambers and carbonizing furnaces, as hereinbefore described.

---

*To WILLIAM MILNER, of Liverpool, fire-proof safe manufacturer, for certain improvements in locks for safes, which said improvements are applicable to locks in general.—*  
[Sealed 20th February, 1854.]

THIS invention is designed for the purpose of protecting locks, of whatever construction they may be, from the destructive effect of gunpowder or other explosive compound or agent; and is more particularly intended to be applied to safes, or such strong depositories as are required to be secured from the invasion of burglars or others.

The improvement consists in filling up all the open space or spaces usually left around the “tumblers” and other working parts of locks; leaving only sufficient space for the turning of the key, the slight lift of the tumblers, and the limited action of the springs, &c.,—thus substituting for what has commonly been the “box” of the lock, almost a solid block of metal. This “filling” may be effected, either by casting or forming



the lock solid, with the exception only of exactly the open space required for the working or operative portions of the lock; or it may be made so as to be formed upon the cap of the lock, and fitted into the ordinary box of the lock, and thus also leave only space sufficient for working, or opening and closing the lock. It will be evident, therefore, that the space which has ordinarily formed a receptacle for a large and destructive quantity of gunpowder, will, by this invention, be reduced to the smallest possible capacity; and the resistance also thus afforded to the effect of explosion, will preserve the lock from destruction by any such means.

In Plate IX., fig. 1, is a front view of the improved lock, and fig. 2, is a sectional elevation of the same, shewing the mode of placing over or in front of the cap of the lock a solid block of steel, which is encased in solid woodwork, occupying the entire space between the first or outer iron plate of the door and the chamber of the safe.

Fig. 3, is a side elevation of the door of an iron safe or chamber, with the improved lock attached, having the bolts thrown and secured by the lock: the solid hard wooden packing is also shewn. The space which, in locks of the ordinary construction, forms a receptacle for gunpowder or other explosive materials, and is called the box of the lock, is filled with a solid block of metal *a*, having just so much metal only removed as will allow sufficient and proper room for the action of the tumblers, springs, and other working parts employed. The extreme amount of space it is possible to pack or fill with gunpowder, or any other explosive material, may be reduced to the minimum, if preferred, by filling up also the greater part of the space for the key, as shewn by the dotted line across the keyhole. In fig. 2, *b*, is a solid block of steel, placed in front of the lock, and by which drilling or cutting into the lock would be materially impeded or prevented; and shewing, by the perforation of the keyhole, the outward course by which any explosion must find vent without injuring the internal works. Fig. 3, represents a door of a fire-proof safe—the inner plate being removed, and shewing the solid packing of hard wood, whereby any space left wherein a deposit of gunpowder or any other explosive material might be made is entirely prevented, and drilling or otherwise perforating the face-plate, for the purpose of inserting gunpowder or any other explosive material, is rendered ineffectual.

The patentee claims the peculiar construction or formation of locks (of whatever arrangement or principle they may be), whereby the destructive effect of gunpowder or other explosive

agent or compound is rendered inoperative, defeated, or prevented, by the means above particularly set forth and described.

---

*To GEORGE TWIGG and ARTHUR LUCAS SILVESTER, of Birmingham, manufacturers, for improvements in apparatus for cutting and affixing stamps and labels,—being partly a communication.*—[Sealed 29th January, 1853.]

THIS invention consists of improvements in apparatus more particularly applicable to the purpose of attaching postage stamps to letters, but suitable also for affixing other labels to similar surfaces.

In Plate IX., fig. 1, is a longitudinal section of the improved apparatus, and fig. 2, a plan from the under side thereof. Fig. 3, is a longitudinal section, shewing another modification of the same apparatus; and fig. 4, is a plan of the same. *a*, is an oblong box, screwed to the stand *b*; *c*, is a bracket, fitting the outside of the box, for the purpose of supporting the bolster *d*; and *e*, is a plate, having the flange *f*, on each side, projecting into and fitting the inside of the box *a*, for the purpose of carrying various parts hereinafter to be described. The plate *e*, and bracket *c*, are firmly secured to the sides of the box. The horizontal shaft *h*, mounted in bearings *i, i*, receives motion from the lever handle *j*. Upon this shaft *h*, a lever *k*, is fixed, which acts on the under side of the sliding-block or piston *l*, (fig. 1,) working vertically in the box *m*, secured to the plate *e*. At one side of this square piston *l*, is attached a steel cutter *n*, the face or cutting side of which works against a steel plate *o*, (fig. 1,) and is kept in close contact by the spring *p*, which is secured to the box *m*, and presses the side of the piston *l*. In the steel plate *o*, there is a slot, the upper edge of which acts also as a cutter, in connection with the corresponding cutter *n*. In the piston *q*, is a carriage, for feeding the machine with continuous strips of postage stamps or labels, which have been previously cut to the width of one stamp or label. The under part of this carriage fits easily, and slides in a slot *r*, formed in the plate *e*, and works in the following manner:—The end of a strip of stamps is introduced between the under side of the spring *s*, and the face of the carriage *q*, and is pushed forward to the vertical sliding-piece *t*. The distance that the carriage *q*, travels is precisely the length of the stamp or label; but may be regulated by the adjusting screw *u*, on the end of which is the small stop *v*, which prevents the carriage working too far.

By raising the lever-handle *j*, the shaft *h*, makes a partial revolution, which moves the cam *w*, fixed on the shaft *h*, and brings the cavity *x*, of the said cam immediately under the vertical sliding-plate *t*; and this sliding-plate is then caused to fall into the cavity of the cam by a small spring *y*, that is attached to the under side of the plate *e*, and acts on the stud *z*, fixed in the sliding-plate *t*. The vertical sliding-plate *t*, works in a slotted plate 2, secured to the end 3, of the plate *e*; the slot being of sufficient width to allow a postage stamp or other label to pass easily through. As soon as the vertical sliding-plate *t*, descends, the stud 4, in the lever *k*, comes in contact with the L-shaped piece 5, underneath the piston *l*, causing the piston to descend; the parts of the machine being so adjusted, that when the piston *l*, has descended to its proper place, the lever 6, fixed on the shaft *h*, comes in contact with the spring 7, secured to the under side of the plate *e*, which acts as a stop to the lever or bracket 8, under the carriage *g*. The lever 6, presses the spring 7, and allows the carriage, charged with stamps, to be moved forward by the spring 9, as far as the small stop *v*; carrying the strip of stamps through the cutting-plate *o*, to the proper distance to be cut off; the spring 8, in the carriage, pressing gently on the strip to prevent it shifting. The stamp is then ready to be cut off, which is done by pressing the handle *j*, downwards—reversing the motion of the shaft *h*, and causing the cam to raise the vertical sliding-plate, and fastening the strip between the upper edge of the sliding-plate *t*, and the slotted plate 2; thus holding the strip whilst the carriage returns to its original position. The lever 6, then liberates the spring 7; and the curved arm 10, (fig. 1,) fixed to the lever *k*, presses the lever or bracket 8, and forces the carriage back to its original place, where it is retained by the spring 7. At the same time, the lever *k*, working on the piston *l*, causes it to ascend and cut off one stamp or label.

The parts shewn in dotted lines represent a reservoir attached to the machine, and which consists of a box, containing in it a roller, covered with flannel or some soft and absorbent material, as shewn at 13. This roller revolves on a spindle, as at 14, and is always partially immersed in the water with which the reservoir is partly filled. The letter or paper to which the stamp or label is to be affixed, having been passed over the top of this roller, is pressed slightly on it, by the spring 15, exerting just sufficient pressure to allow the one corner of the letter to absorb some slight moisture from the wet roller. The damp part is then placed between the bolster *d*, and the piston

*l*, with its face to the piston, by a motion of the lever-handle *j*. The operations hereinbefore mentioned are then performed; and a stamp having been cut off, is brought up by the piston *l*, and attached to the face of the letter.

Figs. 3, and 4, shew views of a modification of the machine, wherein the operations are performed through the agency of a worm on the main shaft, and a crank instead of a lever.

*a*, fig. 3, is a worm-formed lever, something similar to a screw-fan, on the main shaft; and as this shaft revolves, by the motion of the crank handle, the worm acts on the stud *b*, fixed on the under side of the feeding-carriage *g*, and presses it forward for the purpose before described; the carriage being returned to its original position by the spring *c*. The square piston *l*, is worked upwards in manner similar to that in the machine before described; but it is brought down by the spring *e*, working on the small stud *d*, fixed into the piston *l*. *j*, is a spiral spring, allowing a slight resiliency to the bolster *d*, and thereby regulating the pressure: the damping apparatus is the same as that already mentioned.

The patentees claim the general arrangement and combination of the various mechanical contrivances hereinbefore set forth, in producing apparatus for the purpose of cutting and affixing stamps and labels.

---

*To HENRY MOORE NAYLOR, of Montpelier-row, Bloomsbury, Birmingham, for improvements in affixing postage and other stamps.*—[Sealed 11th August, 1853.]

THIS invention consists of a combination of apparatus for affixing postage or other stamps to letters and documents. Such apparatus consists of a chamber to receive a pile of postage or other stamps with the adhesive surfaces upwards; and the upper one is at all times in a position to be taken on to a letter or document, when the same has been moistened by another part of the apparatus, which consists of a roller with a sponge or porous surface, supplied with water by another roller revolving in water, or by an endless cloth.

In Plate IX., fig. 1, is a side elevation of the apparatus; fig. 2, a vertical section, shewing the parts in the act of applying a stamp; fig. 3, is another vertical section of the apparatus, in position ready to receive a letter or document in order that a stamp may be applied; fig. 4, is a vertical section, taken through the water trough; and fig. 5, is another side view,

by which it will be seen that the apparatus may be kept locked. *a*, *a*, is the box or case of the apparatus; *b*, is a trough containing water, in which is placed a roller *c*, coated with sponge or other suitable matter, in order to bring moisture up from the trough; *d*, is a metal roller fitting loosely on its axis; and *e*, is a cover, capable of being moved on its axis *f*, to leave the water-trough and the chamber in which the adhesive stamps are contained, uncovered. The cover carries the axis *f*<sup>1</sup>, of the roller *d*; and the under surface of the cover acts as a guide in introducing the corner of an envelope, or note, or letter, or other document to be moistened, and to receive an adhesive stamp; the cover not fitting down on the table or upper surface of the box *a*. The cover also carries a stop *g*, against which the corner of the document comes when it has been introduced to receive a stamp,—and such stop moves on an axis *g*<sup>1</sup>, and retains its position by gravity. *h*, is a moveable chamber to contain the adhesive stamps to be used, and they are placed in such chamber with their faces downwards, and their backs or adhesive surfaces upwards. On the under side of the cover *e*, there is a projection *e*<sup>1</sup>, of vulcanized India-rubber or other suitable material, which comes over the chamber *h*, and offers a flexible and elastic surface for the envelope, letter, or other document about to receive a stamp to be pressed against it. The moveable chamber *h*, is made on the interior of the form of the stamps to be applied, and it is capable of sliding up and down in the case *a*, of the apparatus; and, by reason of the spring *i*, it has constantly a tendency to rise up so as to come above the table or upper surface of the case *a*. The stamps are placed on the piston *j*, which has below it a plate *j*<sup>1</sup>, acting as the piston-rod, which slides within the chamber *h*; and the piston is constantly drawn down by the vulcanized India-rubber spring *k*. The piston is moved upwards by means of the lever key *l*, which is connected to the lever *m*, by the link or rod *m*<sup>1</sup>; and the lever *m*, is connected to the slide of the piston by the link *n*. Hence, when the key is depressed, the piston with the stamps thereon will rise; and, when released, the piston will descend, and carry with it the chamber *h*, by reason of the greater strength of the India-rubber spring than that which raises the chamber *h*. In using this apparatus the corner of the document or envelope is passed under the cover so as to pass between the moistened roller and the pressing roller,—by which the surface of the paper will be moistened. The document or envelope is then to be moved so as to bring the moistened surface over the chamber *h*, when, by pressing the key *l*, the chamber will be raised by its spring

so as to bring it up to the surface of the moistened paper; and the further movement of the key will raise the piston and force up the stamps, so that the uppermost one will come in contact with the moistened surface,—and the stamp will be pressed forcibly against the moistened surface. The key then being released will allow the India-rubber spring to draw back the piston and the chamber *h*, and the apparatus will be again in position to receive another envelope, note, letter, or document.

The patentee remarks, that for some uses the damping part of the apparatus may be made separate; in which case he prefers to form it as shewn at fig. 6, which is a transverse section of the apparatus. In this arrangement there would only be that part of the previously combined apparatus which consists of the water-trough, the roller dipping therein, and the pressing roller, as will readily be understood. This form of part of the apparatus renders it suitable for moistening surfaces on to which adhesive stamps are to be applied by hand.

The patentee does not claim the separate mechanical parts of which the apparatus is composed, nor does he confine himself to the precise details; but he claims the combination of the mechanical parts, as herein described.

---

To WILLIAM RIGBY, of Glasgow, for improvements in steam-hammers and pile-driving machinery.—[Sealed 5th January, 1854.]

THIS invention relates to two classes of direct-acting steam-hammers. Firstly,—to those in which the steam is used in the ascent of the hammer only; and, secondly,—to those in which it is used in both the ascent and descent.

The patentee claims, as of his invention in hammers of the first class, the making the hammer-block itself in the form of a plunger or ram, passing through stuffing-boxes at both ends of the cylinder,—which plunger or ram, being of larger sectional area at the part passing through the top gland than at that passing through the bottom, on the steam being admitted into the cylinder, its pressure will act on the difference of the areas of the two ends, and will raise the ram to the required height; and, on the steam being allowed to escape, the ram or hammer will fall by its own gravity, and will be guided by the cylinder and stuffing-boxes, without the aid of guides above or below the cylinder, as heretofore used. In hammers of the second class, instead of prolonging the ram

through the top of the cylinder, he makes it to work through the bottom only; and the top of the ram forms a piston for the steam to act upon, both in its ascent and descent. And what he claims in this hammer is not the method of using the steam, but the making the cylinder and lower stuffing-box or gland serve as the guides for the hammer.

In Plate X., figs. 1, and 2, are different views of the single-acting plunger hammer: fig. 1, being a side view, shewing the cylinder and plunger in section; and fig. 2, a plan, partly in section. *a, a*, are the side standards for carrying the cylinder, which is securely bolted to them. These standards are shewn at a considerable angle with the central line of the cylinder; for as they are not required to serve as guides for the hammer-block, they can be placed in any position so as to allow of clear access to the anvil-block *k*, both from the sides and front, if required; or they may be placed in the usual position, as shewn in fig. 3. *b*, is the cylinder, into which the steam is admitted in the usual manner, by the slide-valve *d*, which is opened by the piston in the small cylinder *e*, and reversed at the proper time by the action of the plunger against the lever *m*;—and upon the valve being so reversed, the steam will escape in the ordinary manner, and the hammer will fall by its own gravity. The arrangements for varying the height of fall and force of the blow of the hammer can be of the usual description, and modified according to circumstances. *c*, is the plunger or ram, the upper part of which works through the top of the cylinder, it being cylindrical in cross section, and the lower part being of the form shewn by the plan of the stuffing-box *l*, fig. 2; but it may be made oval, elliptical, or rectangular, or of any other form required, that can be made to pass through a steam-tight stuffing-box (provided it be not made of a circular section), so that it will be prevented from turning by its own form when taking down collars of shafts, forging the bosses of cranks, and the like, and thus obviate the necessity for the parallel guides heretofore used. And further, the upper or larger part of the ram being turned to fit the cylinder, the hammer will be well and securely guided by its contact with the cylinder itself, in addition to the glands *r*, at the top and bottom of the cylinder. *f, f*, are the standards for carrying the valve-gear; *g*, is the steam-pipe for admitting the steam; and *h*, is the pipe for the exhausted steam to escape by. Fig. 3, is a section of the double-acting hammer, in which *a, a*, are the standards for carrying the cylinder; *b*, is the cylinder; and *c*, is the hammer-block, the upper part of which forms a piston; so that, on the steam being

admitted below it, by the slide-valve *d*, it will rise until the tappet *n*, on the piston-rod *o*, which is attached to the hammer, reverses the slide-valve, by its action on the lever *m*, and opens a communication by the passages *p*, and *q*, between the bottom and top of the cylinder; when, owing to there being a larger area on the top of the piston than the bottom, the hammer will fall not only with its own gravity, but be impelled downwards by the action of the steam, and be guided in its fall by the piston (which is made more than usually deep) and by the gland *r*. Upon the valve being again raised, by the piston in the small cylinder *e*, the passages *q*, and *s*, are opened to each other, and the steam from the top of the piston will escape into the atmosphere by the exhaust-pipe *h*, which leads out of the passage *s*. The piston or upper part of the hammer-block *c*, is turned cylindrical, so as to fit the cylinder; but the lower part is made as described before for the plunger-hammer, and for reasons there stated.

---

*To AMBROISE AUGUSTE MASSON, of Paris, manufacturer, for improvements in the manufacture of thread or wire, to be used for making gold or silver lace.*—Sealed 11th January, 1854.

THE object of this invention is to economise the gold used in the manufacture of gold lace. This is effected by an improved mode of gilding the wire or threads, whereby not only is the loss of gold in the drawing and flattening processes prevented, but also half, or nearly half, the precious metal is saved, by covering or gilding only half of the surface or circumference of the wire, although the wire or thread looks as well gilt, and is as ornamental as the ordinary gold-laced thread. The wire used is silver, either pure or alloyed; but other metallic wire may answer the same purpose. This wire should be of the size known as 5½-P, or 6-P thickness. Having been flattened and rolled in the ordinary way, it is to be wound round amber or gold-colored silk,—taking care to avoid any breaks of continuity in the metal. The thread is then passed, by mechanical means, through vessels containing auriferous solutions,—the metal from which is deposited by means of a galvanic or voltaic battery: the wire is then washed, dried, and wound round bobbins. The auriferous solutions may be in a hot or cold state, and the thread may be steeped or simply immersed. In order to render the silk impermeable (and consequently prevent the absorption of a part of the



auriferous matter), it should be steeped, before being covered by the metal, in stearate of alumina, dissolved in distilled water, or in oleic acid much diluted. By tightly binding the metal on the silk, the gold is precipitated only on the metal, the upper part of which alone receives the deposit. From this essential point there flows the advantage of obtaining (with a quantity of gold rather less than half that ordinarily used) a gold thread quite equal in color to that made by the usual mode of rolling, drawing, and burnishing; the principle of the invention being, that in the lace or thread made in this manner the precious metal is used only where seen, and not in the part which serves merely to cover the silk, as in the ordinary manufacture.

In Plate X., fig. 1, is a vertical section of the apparatus employed in this manufacture.

*a*, is the bobbin, from which the thread to be gilt is unwound; *c*, is a counterpoise weight hung at the side of the bobbin, and serving to keep the thread in such a state of tension as to touch, without interruption, the conductors from a battery. *b*, is a conductor communicating with one of the poles of the battery by a wire; *s, s*, are supports, sustaining the conductor *b*; *b'*, is a conductor in communication with the other pole of the battery, serving to suspend the anodes in the bath; *e, e*, are standards for supporting pulleys, which hold the thread in the trough or vessel; *j*, is a trough or vessel, containing the auriferous solution which gilds the thread; and *k*, is a vessel containing water, in which the thread is washed after passing through the bath. *h, h*, are rollers covered with cloth or other absorbent material, on which the thread is dried; the rollers being caused to revolve by some prime mover. *r*, is a small roller placed at the side of the vessel *k*, to prevent the rubbing of the thread. *f*, is a carriage capable of moving laterally, and serving to guide the thread regularly on to the bobbin *d*. *g*, is a piece of curved or looped wire, placed on the carriage *f*, which acts as a guide to conduct the thread. *d*, is the bobbin on which the thread is wound after being gilded. This bobbin is put in motion by means of a cord *v*, by any moving power. The dotted lines indicate the passage of the thread.

The patentee claims, Firstly,—the mode of gilding or silvering one part of the surface or circumference of the wire or thread; that is, the part which is exposed to sight and to friction, in the manner hereinbefore described. Secondly,—the mode of rendering the silk impermeable, or nearly so, so that it should not absorb a part of the bath, in the manner herein-

*Mohler's, for Apparatus for Lubricating Machinery.* 337

before described. Thirdly,—the general arrangements of the apparatus and machinery herein described and shewn, by which each thread is separately and conveniently treated.

---

*To ADOLPHE MOHLER, of Obernay, Bas Rhin, in the French Empire, manufacturer, for certain improvements in apparatus for lubricating machinery.*—[Sealed 2nd February, 1854.]

THIS improved apparatus for lubricating machinery is constructed in such manner that the lubricating liquid is raised and brought in contact with the rubbing surfaces by capillary attraction, in conjunction with the motion of the moving parts.

In Plate X., fig. 1, is a vertical section of the bearing of a vertical spindle or shaft, provided with the improved lubricating apparatus. *a*, is a box or cup containing oil, and provided with a cover *b*; *c*, is a fixed cylindrical pin or stud, on which is fitted the collar or socket *d*, which forms the lower end of the vertical shaft or spindle; *e*, is a pulley for giving motion to the spindle, which may, however, be driven by any other suitable means; and *f*, is a screw-pin, which enters a notch or groove in the stud *c*, and prevents the collar *d*, from rising up on the stud. The revolution of the collar *d*, and the capillary attraction between the collar and stud *c*, cause the oil to ascend and descend between the collar and the stud; and these parts are thus kept constantly bathed with oil. To facilitate the flow of the oil, the bottom of the collar *d*, may be furnished with notches *l*, which are also shewn in fig. 5, which is a plan of the bottom of the collar *d*. The flow or circulation of the oil may be still farther facilitated by forming a passage down the centre of the stud *c*, with a lateral aperture into the oil-cup, as shewn at *g*, in fig. 2, which is a section of an arrangement in other respects similar to fig. 1. Fig. 6, is a sectional plan of the stud and collar shewn in fig. 2. In lieu of forming the passage in the interior of the stud, as in figs. 2, and 6, it may consist of a groove in the side of the stud, as shewn at *h*, in the vertical section, fig. 3, and sectional plan, fig. 7; or it may be simply a flat on the side of the stud, as shewn in the sectional plan, fig. 8. A groove may be formed in the oil-cup in connection with the groove or passage in the stud, as shewn at *k*, in fig. 9, which is a plan of the oil-cup *a*. In fig. 3, the collar *d*, is prevented from rising by a small collar fixed on the stud *c*, by a screw *f*.

The collar *d*, is here shewn with a screw cut on its exterior, for affixing a pulley or wheel; and it is evident that its form may be varied, according to the purpose for which it is required. Fig. 4, is a vertical section, and fig. 10, is a plan, shewing a disc *i*, with grooves *j*, attached to the bottom of the collar *d*. The object of this disc is still further to facilitate or accelerate the flow or circulation of the oil. Fig. 11, is a vertical section of a portion of a horizontal shaft, with the improved lubricating apparatus. The shaft terminates in a socket or collar *d*, as in fig. 1; which is furnished with a disc *m*, dipping into the oil in the box *a*, and running in contact or close proximity with one of the sides *n*, of the oil-cup. *c*, is the fixed stud which fits into the collar *d*, and is firmly fixed to the box *a*. The oil is raised by capillary attraction between the disc and the side *n*, of the box, assisted by the motion of the disc; and it passes along the stud *c*, and the interior of the collar *d*; whence it escapes at the apertures *p, p*, and again falls into the box *a*.

Fig. 12, is a vertical section of another arrangement for lubricating a horizontal shaft. *r*, is the horizontal shaft, which carries a disc *m*, working in a cavity or chamber in the bearing *s*, and dipping into the oil-cup *a*. The oil is raised by capillary attraction between the disc *m*, and the sides of the chamber in the bearing *s*, assisted by the motion of the disc. The oil passes along the shaft and falls again into the oil-cup. *t, t*, are grooves turned in the shaft *r*, to prevent the oil from travelling along the shaft beyond the oil-cup. The disc *m*, may have curved grooves in the sides, as shewn in the side view, fig. 13, to enable it to raise the oil in greater quantity; and its edge may be plain or serrated. The lubricating apparatus may also be applied to inclined shafts; and the particular arrangement best adapted for any particular case will depend on the inclination of the shaft, and the other circumstances of the case.

The patentee claims, Firstly,—the constructing lubricating apparatus, with a collar or socket turning on a fixed pin or stud, and arranged in connection with an oil-cup, in the mode or modes hereinbefore described in reference to figs. 1, 2, 3, 4, 5, 6, 7, 8, 9, and 10. Secondly,—the constructing lubricating apparatus with a collar or socket turning on a fixed pin or stud, and furnished with a disc, running in contact or in close proximity with a fixed surface, and dipping in the oil or lubricating liquid; which is raised by capillary attraction, assisted by the motion of the disc, as hereinbefore described in reference to fig. 11. And, Thirdly,—the constructing lubri-

cating apparatus with a disc fixed on a revolving spindle or shaft, and dipping into the lubricating liquid, and running in close proximity with a fixed surface or two fixed surfaces, as hereinbefore described in reference to fig. 12.

---

*To MOSES POOLE, of the Avenue-road, Regent's-park, for improvements in the manufacture of printing-rollers,—being a communication.*—[Sealed 8th July, 1853.]

THIS invention consists in manufacturing printing-rollers of an alloy of which zinc is the basis, to be substituted for copper in the manufacture of such rollers; whereby a very large saving in cost of material and in labour is effected; and in casting such alloys in metallic moulds under pressure, as hereafter described.

The constituent parts of the alloy, and the manner in which it is made, are as follow:—Melt twelve parts by weight of best selected or pure red copper in a crucible or vessel, and clean it, if required, when in a state of fusion, by those means which brass-founders may consider most effective, such as by sprinkling over it small pieces of charcoal. In another crucible or vessel fuse or melt three parts of antimony, and add thereto, when in a state of fusion, three parts of lead. In a third crucible or vessel (of dimensions adequate to contain at least fifty-four parts of various metals, and which is to be kept covered as much as possible) fuse or melt slowly, by the use of a coke fire, twenty-four parts of pure zinc, which has not been previously used for any purpose; and, when in a state of fusion, cover its surface with powdered charcoal, in order to prevent volatilisation, and also for cleaning the metal. Afterwards pour into such last-mentioned zinc, while in a state of fusion, the alloy of antimony and lead, above described, while in a like state of fusion, and also the red copper above mentioned, while in a state of fusion, having previously carefully removed from the melted copper and melted zinc all particles of charcoal and dirt therein; and then add to the whole twelve parts of tin, introducing it gradually by small quantities, and stirring it carefully, during the process of mixture, with a suitable implement, by preference, of wood. Before any of the metals, contained in the melted mass last mentioned, have separated from each other, cast the whole mixture into ingots. When these ingots have cooled, fuse or melt them again in a crucible or vessel, and in another crucible or vessel melt or fuse a new

mixture, consisting of twenty-four parts of zinc, and cleanse the same, when melted, with powdered charcoal or otherwise, as above mentioned; and afterwards add to it, when in a state of fusion, twelve parts of block-tin,—taking great care to prevent, as much as possible, the volatilisation of the zinc. Then carefully skim off or remove all dirt which may be found on the surface of the metals in fusion in the two last-mentioned crucibles or vessels, and pour the contents of the one crucible into the other,—carefully stirring the whole during the process of admixture, and continue to stir them, and to keep the whole in a state of fusion until it is found that the contents of the two crucibles, thus united, may be stirred by the implement used (and which is also preferred to be of wood) with the same ease as water, which is one proof of a complete mixture. A further proof of the mixture being complete is afforded, when, on taking out the implement used for this stirring, its surface is clean and presents no trace of metal. The alloy is then to be cast for use into ingots; for, although it may be employed at once for the manufacture of rollers, yet it is preferred to be previously cast into ingots, and subsequently melted for use, as the grain of the alloy, constituting such rollers, will, in the latter case, be finer and closer. Such are the component parts of and mode of composing the metallic alloy to be employed for rollers; and although, in case of an analysis, it may be found that the quantities of the metals above mentioned present more or less differences on account of the greater or less liability to volatilisation of some of them, nevertheless zinc, though most liable to volatilise, will always constitute the greatest proportion of the whole. The alloy is to be cast, in suitable moulds, into proper rollers for printing; but it is preferred, for this purpose, to employ an apparatus called the “compressing shell apparatus.” This apparatus consists of two longitudinal semi-circular semi-cylinders, so made as to form, when the edges are joined together, as near as may be, a circular hollow centre, with machinery or apparatus to compress gradually the above-mentioned metallic alloy when in a compressible state, and within such semi-cylinders, by, as near as may be, an equal pressure along the entire length of the cylinders.

In Plate X., fig. 1, is a transverse section of the whole apparatus; and figs. 2, and 3, represent the ring which is adjusted on the top of fig. 1. *a, a*, is a stone or metallic block, with a large opening *a*<sup>1</sup>,—the surface *a*<sup>2</sup>, being smooth and level; *a*<sup>3</sup>, *a*<sup>3</sup>, is a vertical hole in the centre of the block; and *b*, is a metallic body or core, which is to form the inside of

the proposed roller, either temporarily only, for the purpose of the compression, or permanently, at the will of the operator. This roller has a spindle at the lower end  $b^1$ , of a size to fit into the above-mentioned vertical hole  $a^3$ ,  $a^3$ , of the block  $a$ ,  $a$ . The shape and size of the core  $b$ , should correspond with the shape and size of the tree proposed to be afterwards fixed into the rollers when worked; and care should be taken that the surface of the core is very smooth, and that the shape of the core  $b$ , is slightly conical, decreasing gradually in diameter from its base to the top.  $b^2$ , is a spindle on the top of the core  $b$ , and is required to keep the core perfectly steady in the centre of the mould, during the process of compression.  $c$ , is a bell-shaped moveable vessel, placed on the top of the core  $b$ , for directing the course of the alloy of metal when poured into the mould.  $d$ ,  $d$ , represent the sections of two semi-cylinders, so made as to constitute, as above stated, when in juxta-position, as near as may be, a cylinder. The part  $d^1$ , (being the base) requires to be very smooth and even, for the purpose of easily moving or sliding on the block  $a$ ,  $a$ . The upper ends  $d^2$ ,  $d^2$ , are arranged for the reception and support of two other semi-cylinders  $d^3$ ,  $d^3$ , whose lower ends  $d^4$ ,  $d^4$ , are to be made so as to fit into the before-mentioned parts  $d^2$ ,  $d^2$ .  $d^5$ ,  $d^5$ , shew two projecting shoulders on each side of the two semi-cylinders  $d$ ,  $d$ , nearly in the centre thereof, for the reception of wedges  $h$ ,  $h$ ; and  $d^6$ ,  $d^6$ , shew the form of the outer edges of the semi-cylinders  $d$ ,  $d$ . The semi-cylinders  $d$ ,  $d$ , should be of the length of the intended roller.  $e$ ,  $e$ , are two pieces or slips of iron, of the same length as the semi-cylinders  $d$ ,  $d$ , or from  $d^1$ , to  $d^2$ , to be placed against those points where the semi-cylinders  $d$ ,  $d$ , will meet when under compression, as after mentioned; and it is important that the surfaces at  $d^6$ , and  $e$ , should be exceedingly smooth and even,—care being also taken that the ends of the slips  $e$ , at the points  $e^1$ ,  $e^1$ , are so made as to clasp or encase the semi-cylinders  $d$ ,  $d$ .  $f$ , is a strong wrought-iron collar, which rests upon the shoulder  $d^5$ ,  $d^5$ .  $g$ , is a piece of cork, or other elastic substance, placed between the collar  $f$ , and the metallic piece or slip  $e$ .  $h$ ,  $h$ , are wedges, made of wrought-iron, introduced into the grooves  $d^5$ ,  $d^5$ .  $i$ , is a wrought-iron collar or hoop, surrounding the parts  $d^2$ ,  $d^2$ , and  $d^4$ ,  $d^4$ , of the semi-cylinders.  $k$ ,  $k$ , fig. 3, are the top apparatus or ring for keeping steady the core  $b$ , during the process of compression.

The foregoing apparatus is arranged as follows:—The block  $a$ , is placed upon a level surface; then the core  $b$ , is fixed in

a vertical position by its spindle  $b^1$ , in the hole  $a^3$ ,  $a^3$ , of the block,—the surface of the core  $b$ , having been coated with dry smoke, obtained in the usual way. The smoke of resin is very good for this purpose. The bell or conical apparatus  $c$ , is then fixed on the top of the core  $b$ . All the parts are first heated to about 150° centigrade before putting them together, and a charcoal fire is lighted under the block  $a$ , at the inner side  $a^1$ , to keep up the temperature of the apparatus to about 150° centigrade, until the alloy has been poured into the cylinder, when the fire should be extinguished.

The same cylinders  $d$ ,  $d$ , having been duly smoked on the interior surfaces, and heated, are placed vertically on the block  $a$ ,—taking care that the core  $b$ , is precisely in their centre. The slips  $e$ ,  $e$ , are also fixed at the points where the surfaces  $d^6$ ,  $d^6$ , of the semi-cylinders meet, as shewn in fig. 2. Thus the two semi-cylinders  $d$ ,  $d$ , and the two slips  $e$ ,  $e$ , constitute a complete cylinder or mould, equi-distant from the core  $b$ . The pieces of cork, or other elastic body, are then placed on the outside of the slips  $e$ ,  $e$ ; and the collar  $f$ , is fixed round the whole (which collar, when fastened by screws or otherwise, holds the apparatus  $d$ ,  $e$ , and  $g$ ,) together. The wedges  $h$ ,  $h$ , are then inserted on either side of the two cylinders at the points  $d^5$ ,  $d^5$ . The two semi-cylinders  $d^3$ ,  $d^3$ , having been previously heated and smoked, are fastened at the points of their junction with the top ends of the semi-cylinders  $d$ ,  $d$ , by the iron collar  $i$ . These two upper semi-cylinders  $d^3$ ,  $d^3$ , being intended to form the rising head-runner or get, for obtaining pressure to the metal which is to form the roller, do not require to be squeezed, and have no slip between them. On their upper part are adjusted the four arms of the apparatus or ring intended for keeping the core  $b$ , steady in the centre of the mould. For ensuring that the metal shall not run out of the mould during its introduction, the various connecting parts may be covered with clay. Directly after the introduction of the metal, its squeezing is to take place by forcing down the wedges  $h$ ,  $h$ , by blows, or by pressure otherwise applied with, as near as may be, equal force; and this equality may be secured by the application of a wrought-iron key or instrument, with two legs, united above in the manner shewn at  $m$ ,  $m$ , fig. 1; so that, by placing the ends  $m^1$ ,  $m^1$ , on the top of the wedges  $h$ ,  $h$ , and striking such key at the top on the point  $m^2$ , the force applied to those wedges must be equal.

The rollers are to be finished, after casting, by smoothing or removing inequalities from the surface, by filing or turning,

as is well understood. The basis of the alloy of which the improved rollers are made is zinc; and although the substances and proportions above given are those found and believed to be best for general purposes, the same may be varied to some extent, the basis of the alloy being zinc. A small quantity of arsenic (say, half to three quarters of an ounce to a pound of the alloy introduced at the last melting) may be added with advantage,—that being well known to improve the homogeneity of alloys of metal. If sulphuric acid be present in the color and mordants in a state not considerably diluted, rollers, with the greater relative proportion of lead, will be less acted on than those with less.

The patentee claims the manufacture of printing-rollers by casting them of an alloy of which zinc is the basis; and the casting of such rollers in metallic moulds, as above described.

---

*To* RICHARD ALBERT TILGHMAN, of Philadelphia, United States of America, chemist, for improvements in treating fatty and oily matters, chiefly applicable to the manufacture of soap, candles, and glycerine.—[Sealed 9th January, 1854.]

THE first part of this invention consists in a mode or modes of obtaining free fat acids and solution of glycerine from those fatty or oily bodies, of animal and vegetable origin, which contain glycerine as their base.

For this purpose these fatty or oily bodies are subjected to the action of water at a high temperature, under pressure, so as to cause the elements of those bodies to combine with water, and to obtain, at the same time, free fat acids and solution of glycerine.

The fatty body to be operated upon is mixed with from a third to a half of its bulk of water, and placed in any convenient vessel in which it can be subjected to the action of a temperature about the same as that of melting lead, until the operation is complete: the vessel must be closed, so that the requisite amount of pressure may be applied to prevent the conversion of the water into steam.

The process may be performed more rapidly, and also continuously, by causing the mixture of fatty matter and water to pass through a tube or continuous channel, heated to the temperature already mentioned; the requisite pressure for preventing the conversion of the water into steam being applied during the process.



In Plate X., fig. 1, shews, in vertical section, an apparatus for performing this process speedily and continuously, and fig. 2, is a horizontal section of the same. The fat or oil is placed, in a fluid state, in the vessel *a*, with from one-third to one-half its bulk of warm water; and the disc or piston *b*, perforated with numerous small holes, being kept in rapid motion up and down in the vessel *a*, causes the fat or oil and water to form an emulsion or intimate mechanical mixture. A force-pump *c*, like those in common use for hydraulic presses, then drives the mixture through a long coil of very strong iron tubing *d, d*, which, being placed in a furnace *e, e*, is heated by a fire *f*, to about the temperature of melting lead. From the exit end *g*, of the heating tubes *d, d*, the mixture, which has then become converted into free fat acids and solution of glycerine, passes on through another coiled iron tube *h, h, h*, immersed in water, by which it is cooled down from its high temperature to below 212° Fahr.; after which it makes its escape through the exit-valve *i*, into the receiving vessel. The iron tubes employed for this purpose are about 1 inch external diameter, and about half an inch internal diameter, being such as are in common use for Perkins' hot-water apparatus. The ends of the tubes are welded together, to make the requisite length; but where welding is not practicable, the kind of joints used for Perkins' hot-water apparatus is employed. The heating-tube *d, d, d*, is coiled several times backwards and forwards, so as to arrange a considerable length of tube in a moderate space. The different coils of the tube are kept about one quarter of an inch apart from each other; and the interval between them is filled up solid with cast-iron, which also covers the outer coils or rows of tubes, to the thickness of half or three-quarters of an inch, as shewn in fig. 2. This casing of metal insures a considerable uniformity of temperature in the different parts of the coil, adding also to its strength, and protecting it from injury by the fire.

The exit-valve *i*, is so loaded that, when the heating-tubes *d, d, d*, are at the desired working temperature, and the pump *c*, is not in action, it will not be opened by the internal pressure produced by the application of heat to the mixture; and therefore nothing escapes from the valve *i*, if the temperature be not too high. But when the pump forces fresh mixture into one end *j*, of the heating-tubes *d, d, d*, the exit-valve *i*, is forced open, to allow an equal amount of the mixture, which has been operated upon, to escape out of the cooling-tubes *h, h*, at the valve *i*, placed at the other end of the apparatus. No steam or air should be allowed to accumulate in the tubes,

which should be kept entirely full of the mixture. For this purpose, whenever it may be required, the speed of the pump should be increased, so that the current through the tubes may be made sufficiently rapid to carry out with it any air remaining in them. Although the decomposition of the neutral fats by water takes place with great quickness at the proper heat, yet it is preferred that the pump *c*, should be worked at such a rate, in proportion to the length or capacity of the heating-tubes *d, d, d*, that the mixture, while flowing through them, should be maintained at the desired temperature for about ten minutes, before it passes into the refrigerator or cooling parts *h, h*, of the apparatus.

The melting point of lead has been mentioned as the proper heat to be used in this operation, because it has been found to give good results; but the change of fatty matters into fat acids and glycerine takes place with some materials (such as palm oil) at the melting point of bismuth; yet the heat has been carried considerably above the melting point of lead without any apparent injury, and the decomposing action of the water becomes more powerful as the heat is increased. By starting the apparatus at a low heat, and gradually increasing it, the temperature giving products most suitable to the intended application of the fatty body employed, can easily be determined.

To indicate the temperature of the tubes *d, d, d*, the successive melting of metals and other substances, of different and known degrees of fusibility, is found to be convenient in practice. Several holes, half an inch in diameter and two or three inches deep, are bored into the solid parts of the casting surrounding the tubes, each hole being charged with a different substance. A straight piece of iron wire, passing through the side of the furnace to the bottom of each of the holes, enables the workman to feel which of the substances are melted, and to regulate the fire accordingly. It is important for the quickness and perfection of the decomposition, that the oil and water, during their entire passage through the heating-tubes, should remain in the same state of intimate mixture in which they enter them. It is therefore preferred to place the series of heating-tubes in a vertical position, so that any partial separation which may take place while the liquids pass up one tube may be counteracted as they pass down the next. It will be also found useful to fix, at intervals, in the heating tubes of such apparatus as may admit of such an addition, diaphragms, pierced with numerous small holes; so that the liquids, being forced through these obstructions, may be tho-

roughly mixed together. It is deemed prudent to test the strength of the apparatus by a pressure of 10,000 lbs. to the square inch, before taking it into use; but the working pressure necessary for producing the heat mentioned will not be found to exceed 2000 lbs. to the square inch. When it is desired to diminish the contact of the liquids with iron, the tubes or channels of the apparatus may be lined with copper.

The hot mixture of fat acids and solution of glycerine, which escape from the exit-valve of the apparatus, are separated from each other by subsidence; the fat acids may then be washed with water, and the solution of glycerine concentrated and purified by the usual means.

The fat acids, thus produced, may, like those obtained by other methods, be used in the manufacture of candles and soap, and applied to various purposes according to their quality; and, when desired, they may also be first bleached or purified by distillation or otherwise, as is now well understood.

It is preferred that the fatty bodies should be previously deprived, as far as practicable, of such impurities as would cause the discoloration of the fat acids produced; but when the fat acids are to be finally purified by distillation, this preliminary purification is of less importance.

When any acid or other corrosive agent shall have been used for purifying, hardening, or otherwise preparing the fatty body to be operated upon, care should be taken that all traces of it are washed out or neutralized before passing it through the apparatus. Some fatty bodies (particularly when impure) generate, during the process, a portion of acetic or other soluble acid, which might tend to injure the iron tubes; in such cases a corresponding quantity of alkaline or basic matter is added to the water and oil before they are pumped into the tubes.

The second part of this invention consists in a mode of treating a mixture of fatty matters (whether acid or neutral) and a carbonated alkali, for the purpose of manufacturing soap.

For this purpose the fatty bodies are mixed, in a liquid state, with the quantity of carbonated alkali, in solution, which may be necessary to convert it into soap; and then the mixture is subjected to a high temperature, under pressure, in like manner as hereinbefore described in obtaining fatty acids and glycerine. And for this purpose, the apparatus hereinbefore described for producing the fatty acids and glycerine, by a continuous process, may be used for the production of soap in a similar manner. The carbonated alkali may be dissolved merely in the quantity of water which is intended to

remain in the soap produced. If resinous or other matters are intended to be used in the manufacture of the soap, they may be dissolved, either in the alkaline solution or the oil, or may be combined with the soap after it has left the apparatus.

The degree of heat required is less than that which is necessary to produce free fat acids, and should generally be kept between the melting points of tin and bismuth. At about 350° Fahr., the neutral fats will form soaps, with the solution of alkaline carbonates; but a higher temperature will produce the result more quickly.

The carbonic acid expelled from the alkali in this process, when performed in the apparatus above described, escapes as the soap issues from the exit-valve. If but little water has been used, and the quality of the soap is sufficiently good without further purification, it can be put into frames to harden at once; or it may be put into the coppers, boiled up, and separated from the glycerine (when neutral fats have been used), and finished in the usual manner.

The patentee claims, First,—the manufacturing of fatty acids and glycerine from fatty bodies, by means of water and heat acting thereon as hereinbefore described. And, Secondly,—the manufacturing of soap, by treating a mixture of fatty matters and a carbonated alkali as above described.

---

*To DAVID KENNEDY, of the City of Reading, in the State of Pennsylvania, in the United States of America, manufacturer, for an invention for the use of tanners; being certain compositions of matter to be used in the manufacture of leather.—[Sealed 3rd January, 1854.]*

THE patentee states that, in manufacturing leather according to the plan now generally adopted, the hides, after having been properly soaked in water (and softened by breaking, when necessary), are treated with lime mixed with water to about the consistence of whitewash, for the purpose of removing the hair or wool, fat, mucous, and other matter, which would retard the process of tanning and injure the quality of the leather. The liming, especially when the process is slow, has a tendency to impair the strength of the fibres of the hide, and render the leather, produced from it by subsequent tanning, harsh and stiff. To prevent this, the patentee proposes to treat it with a composition which acts with greater energy, is more effective than lime alone, and does not impair the strength of the fibre. This composition consists of fresh

slacked lime, one bushel; of fresh wood-ashes, one bushel; of sal-soda (also called carbonate of soda), eight pounds; and sufficient water to mix these materials into a liquid of the proper consistency and strength; using one-and-a-half bushels of this composition with the same quantity of water, and to perform the same duty for which two bushels of lime is ordinarily used. The composition should be mixed in a vat of the proper size, and kept at the temperature of about summer heat,—say from 76° to 84° Fahr. The hides must be kept in a state of agitation, by being constantly handled, from the time they are placed in the vat with this composition, until the operation is complete; which can only be determined by actual inspection, as differences in the character and state of the hide hasten or retard the process. On the completion of this depilatory process, the hide should be thoroughly cleansed by washing it in a copious supply of water; after which it will be ready for tanning, or to undergo the bating process, according to its nature and quality, or the purpose to which it is to be applied.

Bating the hide, so called, consists in immersing it in a mixture of the dung of domestic fowls with water or any of the other well-known bating liquors; but that made from the dung of domestic fowls is preferred. The object of bating is principally to remove from the skin the lime with which it became impregnated during the depilatory process previously described. This removal is effected by the combination with the lime of some ingredient of the bating liquor that will make a salt soluble in water. Such a salt of lime is formed when the liquor prepared from the dung of fowls is used, and washed away when the hides are rinsed, on the completion of the bating. In this manner the lime is effectually removed.

The bating liquor should be kept at a temperature of 80° Fahr., and the hides attentively watched and constantly handled during immersion,—which is necessary to expedite the process and prevent putrefaction.

The hides being properly prepared by the before-mentioned processes, are ready for tanning, which is effected by immersing the hide in a liquor prepared by a solution of the new tanning composition in water or bark-water. This composition consists of 24 lbs. of valonia or divi-divi, 8 lbs. of sulphate of soda, 4 lbs. of sulphate of magnesia, 1 lb. of sulphate of alumina and soda (soda alum), 2 lbs. of sal-soda (carbonate of soda), 1 lb. of borax or boracic acid, and 1 lb. of liquid ammonia. These ingredients should be dissolved separately in hot water, or in a hot decoction of bark (which

is preferable), and then poured into a tank and thoroughly stirred together to form the tanning liquor,—which may be drawn as required to supply the vats or vessels in which the hides are to be tanned. The tanning liquor thus formed in the tank is in the most concentrated form, and only suitable to apply to hides in the advanced stages of the tanning process; and must be largely diluted with water or bark water before it is applied to hides at the commencement of this process, or else partially spent by having been applied to hides in a more advanced state. The hides, as the tanning advances, may be treated with liquor progressively stronger; care being taken to handle the hides frequently in the early part of the process, while the liquor is weak; but less handling will do as the process advances: so that the hides intended for sole leather, near the close of the process, may be laid down in a vat alternately with layers of ground bark, and then a liquor composed of three parts of the composition before mentioned, and one of good bark liquor, must be poured into the vat until the hides are covered. In this condition they may be from ten to fifteen days, when they will be completely tanned. Light skins need not be laid down, as they will be thoroughly tanned by handling in the liquor alone.

Hides may be tanned by this process, fast or slow, according to the amount of handling and the strength of liquor employed. When a tan-yard has become impregnated thoroughly with the chemicals employed, it can be kept with much less expense than at first; and the quality of leather will be noticeably improved, and the time of tanning lessened.

When the before-mentioned tanning compound is employed with hemlock-bark, in the proportion of 15 lbs. of the compound to about 128 cubic feet of the bark, the leather produced will have the color, pliancy, and other desirable qualities of the best oak-tanned leather. In this way, the expense of oak-tanned leather will be greatly reduced, while the quality will be fully maintained.

The materials employed in the before-named tanning composition may be replaced by others possessing similar properties; as, for example,—instead of the valonia or divi-divi, terra-japonica, blood-root, nut-galls, cutch, gambiers, sumach, quercitron bark, catechu, or other like concentrated tanning material, may be employed; but the valonia, and, next to that, the divi-divi, is preferred. The other ingredients of the composition may be replaced by any of their known equivalents.

The patentee claims the combination of valonia, or the equivalent thereof, with the sulphate of soda, magnesia, and

alumina, and sal-soda, and boracic acid, or their equivalents, dissolved in water, bark-liquor, or a solution of tannin, for the purpose of tanning hides and skins. Secondly,—the sulphate of soda, or the equivalent thereof, in the foregoing composition; not because it aids in the tanning process, but because it gives to the leather a clear, bright, and durable color; so that while the tanning chemicals ensure a leather of good quality, this ensures a good color and saleable appearance. Thirdly,—the sulphate of magnesia, for the purpose of inducing a more rapid combination of the tannin with the skin,—which is highly important when expedition is desirable. Fourthly,—the sal-soda, because of its mild alkaline properties, which, acting upon the skin, modifies the harsher action of the lime and ashes, so as to leave the skin softer and in better condition for the reception of the tannin than any other preparation tried or known; and, by keeping this salt in due proportions in the tanning liquor, it preserves the softness of the skins to the completion of the tanning process. And, Lastly,—the employment of the borax for the purpose of giving increased density and firmness to the leather, so that it may not be deficient in these qualities, at the same time that it possesses great pliancy.

---

*To JOHN TAYLOR, of Princes-square, in the county of Middlesex, engineer, for an improvement in the treatment or preparation of skins,—being a communication.*—[Sealed 30th September, 1853.]

THIS invention consists in substituting for the yolk of eggs, now employed in treating or preparing skins, the brains of animals, the natural properties of which render them eminently suitable for this purpose. The brains are dissolved in warm water, and the solution is strained, to free it from bones, hair, and other extraneous matters; after which it is used, either alone or mixed with flour, or some similar substance, until it assumes a pasty consistence, precisely in the same manner as the yolks of eggs are now generally employed. The quality of the inferior kinds of skins may be also improved, so as to render them fit for use in glove-making, &c., by placing them in a close vessel, and introducing animal brains, dissolved in water or other liquid, into the pores of the skins, by a pump, press, or other suitable means.

The patentee claims, in the treatment or preparation of skins, the employment of the brains of animals, as a substitute for the yolks of eggs as now used in the preparation or treatment thereof.

To MICHAEL LEOPOLD PARNELL, of the Strand, in the county of Middlesex, lock manufacturer, for improvements in the construction of locks.—[Sealed 9th September, 1853.]

THESE improvements in the manufacture of locks consist of an improved detector-stop; of improved stops to resist or frustrate pressure exerted on the bolt endwise, or in the direction of the bolt's motion; and of an improved curtain, for preventing the introduction of several picks, at one time, to act upon the levers or tumblers.

In Plate IX., fig. 1, represents the improvements applied to a door-lock,—the cover-plate and curtain being removed to shew the “detector” portion more clearly; and fig. 2, represents the same lock, with the levers or tumblers removed to shew the position and operation of the “end pressure-stop.” *a*, is the box or case of the lock; *b*, the bolt; and *c*, the stump; *d, d'*, the tumblers, supported on a central axis *e*, situated between the two extremes,—the gating being on one side of the axis, and the detector-springs upon the opposite side. *d<sup>1</sup>, d<sup>2</sup>*, are two inclines, formed upon the inner end of the tumblers; and *f, f'*, are the detector-springs acting upon the inclines. In the position of the parts shewn in fig. 1, it will be seen that the detector-springs act upon the lower incline *d<sup>1</sup>*, thereby tending to depress the opposite end of the tumblers; but if one of the tumblers be over-lifted, by means of a pick or false key, the spring of that tumbler is brought to bear on the upper incline *d<sup>2</sup>*; thereby elevating the opposite end of the tumbler, and retaining it in that position, so as to prevent the stump from entering the gating *g*, of the tumbler. One kind of end pressure-stop employed is shewn at *h*, fig. 2, and detached at fig. 3. It turns upon an axis fixed to the casing of the lock (preferably the axis of the tumblers), and is pressed against the stump by the tumblers; and in this position relieves the tumblers from all end pressure, rising (by the action of the spring *i*,) only when the last tumbler is raised, so as then to permit the stump to enter the gating of the tumbler. *j*, represents another kind of end pressure-stop; it consists of two arms 1, 2, turning upon a pin immediately above the bolt. The arm 1, in the position shewn in fig. 2, relieves the tumblers from all end pressure, and it is raised by one of the tumblers acting upon the stud or pin *k*, on the stop, to allow the bolts to recede; but, should it be over-lifted, the end 2, descends behind the back end of the bolt, and prevents it passing. When the bolt is shot out, the stop may be restored to the position shewn in fig. 2, by



the action of the tumbler upon the end 2, or by a spring. This stop may be modified by suppressing the arm 2, and employing a spring to depress the arm 1.

Another mode of frustrating the effect of end pressure upon the bolt is shewn in fig. 4, and consists in cutting, in all the tumblers, a false notch *m*, situate immediately behind the stump when the bolt is shot. The bolt is held out, to its full extent, by the yielding-stop *n*, or any other convenient contrivance. Upon the application of pressure the stop *n*, yields, and the bolt slightly recedes, but is stopped by the stump entering the false notches *m*, in the tumblers.

Figs. 5, and 6, represent the improved curtain,—fig. 5, being a view of the side next the lock, and fig. 6, a section; the improvement consisting in the addition of a socket *o*, to the curtain *p*,—such socket descending to the bottom of the lock, and turning upon the ward *q*, surrounding the drill-pin; or, in case of locks which lock from both sides, surrounding the hole which receives the pin of the key.

Figs. 7, 8, 9, and 10, represent one of the improved end pressure-stops applied to an ordinary cabinet tumbler lock. In this application the stop is represented as acting within the outer chambers of the tumblers. Fig. 7, represents the lock with the face-plate and curtain removed; fig. 8, the lock with the tumblers removed, to shew, more clearly, the action of the stop; and figs. 9, and 10, shew the stop detached. The patentee remarks, that the first and second of the end pressure-stops, above described, may be employed in the same lock, as shewn in figs. 1, and 2.

The patentee claims, First,—the improved detector-stop, in which the tumblers or levers turn upon an axis situated between the two ends of the levers, and have two inclined planes formed upon their inner ends, upon which inclines the springs act, as hereinbefore described. Second,—the end pressure-stop turning upon an axis fixed to the case of the lock (preferably upon the tumbler axis), and kept down by the levers, as hereinbefore described. Third,—the end pressure-stop (whether with one or two arms) turning upon a pin placed immediately above the tumblers, and raised by the action of one of the tumblers, as hereinbefore described. Fourth,—the end pressure-stop, formed by cutting a false notch through all the tumblers immediately behind the stump (when the bolt is shot) to receive the stump, so as to prevent the bolt receding beyond the depth of the false notch,—the bolt being retained in its proper position by a yielding stop. And, Lastly,—the improved curtain, having a socket formed

upon it, which turns upon a cylindrical ward, and descends to the bottom of the lock,—the ward being concentric with the drill-pin, or, in the case of locks which lock from both sides, with the hole which receives the key-pin.

---

To BENJAMIN HUSTWAYTE, of *Hockley-street, Homerton, bricklayer*, and RICHARD JOHN PAUL GIBSON, of *Upper Brunswick-street, Hackney, builder*, for an improved composition or compositions applicable to the manufacture of bricks, tiles, and other moulded articles.—[Sealed 7th September, 1853.]

THIS invention relates to the manufacture and use of an improved plastic composition, which, when moulded into bricks, tiles, or other articles, will set quickly, and will require no firing to render it capable of resisting the action of the atmosphere. In making this composition, fine river or well-washed sand or ballast is employed as the body or chief ingredient, and blue lias lime or Dorking lime and Portland cement, or Roman cement, are added thereto in a dry state. These ingredients are mixed well together, and, when the composition is required to be used, water is added thereto, with stirring, and a plastic substance is produced, which is capable of being moulded to any required form, and will set or harden very quickly. According to the color which the articles to be manufactured are required to assume, yellow ochre, red lead, or red ochre, or other coloring matter is added; and thus bricks, tiles, vases, figures, &c., may be produced, of a yellow, red, or other tint which taste may dictate.

The following are the proportions in which it has been found most advantageous to use the materials which constitute the improved manufacture:—For the production of a white composition, which will manufacture into one hundred bricks, full size, making four courses to the foot, take one-and-a-half peck of Portland cement, one peck of blue lias lime, and three pecks of ballast or sand. When this composition is required to be used, hot water is added (with stirring) in sufficient quantities to form a plastic mass, which, when well mixed, is cast into moulds.

For the production of red bricks, tiles, &c., the composition is modified by the introduction of suitable coloring materials, as Venetian red 1 lb. and red ochre 1 lb. to the proportion of plastic materials above given,—hot water being added when the composition is required to be used.

In order to give the improved composition a yellow tint, and render it suitable for producing yellow bricks and tiles, 1 lb. of green copperas, 1 lb. of yellow ochre, and 1 lb. of American potash are added. When the composition is required to be used, hot water is mixed therewith, in the manner and proportion above indicated.

The patentees claim the manufacture of a composition capable of being moulded by the admixture of Portland or Roman cement with blue lias lime and ballast or sand, whether combined with coloring matter or not, as above set forth.

---

*To ARNOLD MOREL FATIO, merchant, and FRANÇOIS VERDEIL, medical doctor and chemist, both of Paris, for improvements in preserving animal and vegetable substances.—*

[Sealed 31st January, 1854.]

THIS invention consists in the employment of the following means for the preservation of vegetables, meat, and fish:—The substances to be preserved, after having been previously prepared, according to their peculiar nature, as will be hereafter described, for the preserving process, are submitted to the action of heated steam; that is to say,—steam supplied from a generator at any convenient pressure of atmospheres, by preference four or five atmospheres, and heated by means of any suitable apparatus. The animal or vegetable substances will thus be speedily cooked, without having the goodness washed out of them, or their quality deteriorated, as is the case when water is employed for that purpose. After having been submitted to the action of the steam for a suitable time, the substances are to be dried by artificial means, in heated stoves, which may be provided with blowers, or into or through which a current of hot air may be forced, or they may be dried in a vacuum apparatus. By the action of the steam the albumen contained in the substances operated upon will be coagulated, and the fermentable principles destroyed; and, on afterwards drying them at a low temperature, for the purpose of carrying off the water which they contain, the substances will be rendered unchangeable, and may be kept for any length of time. When required for use, it is only necessary to boil the substances so prepared in hot water, and they will have all the quality and flavor of meat, fish, or vegetables cooked when fresh.

By means of this process the substances may be supplied to those countries where they are not to be obtained in a fresh

state, and vegetables may be obtained in winter as well as in summer. When vegetables are to be operated upon, they are to be trimmed, cleansed, and cut up, or divided, according to the state in which it is desired to preserve them. They are then placed upon frames, covered with canvas, or upon wattles, and introduced into a close vessel or chamber, such as that shewn in Plate X., in which fig. 1, is a vertical section of the vessel; and fig. 2, a horizontal section. Steam is introduced through the pipes *b*, into this vessel at a suitable pressure, and is allowed to escape from the pipes *b*, into the interior of the vessel from jets *c, c*. It is advisable to provide the apparatus with a small aperture for the escape of a small portion of the steam, the exit of which may be regulated by a pipe and cock, or by a small safety-valve, as the vegetable will by this means be much better cooked. The form and dimensions of the steaming apparatus may be variously modified according to circumstances, but that which is preferred consists of an iron casing, having a coil of perforated pipe running through it, for the purpose of supplying the steam to the interior of the apparatus, which is provided with a door or opening for the introduction of the frames *a, a*, and is hermetically closed before the introduction of the steam. When the vegetables are sufficiently cooked, the frames *a, a*, upon which they are placed, are withdrawn from the chamber, and the vegetables are transferred to any suitable drying apparatus. The one best adapted for this purpose consists of a stove into which air, heated to from 90° to 100° or 110° Fahr., is forced or drawn, by means of fans or blowers, in such manner that the heated air shall be caused to act equally upon all the frames on which the vegetables are placed. When dry, the vegetables will be no longer liable to change, and will be preserved, even if exposed to the contact of the atmosphere.

All kinds of vegetables may be preserved in the manner above described; but as the patentees are aware that somewhat similar means, such as the cooking potatoes by steam, have been employed for the preservation of potatoes, they propose to apply their process to the preservation of the following vegetable substances, viz:—Peas, asparagus, champignons, spinach, French beans, haricot beans, carrots, cabbages, Brussels sprouts, truffles, beet root, Windsor and other beans, turnips, sorrel, mushrooms, salsify or goats' beard, endive, lettuce, celery, chevril, onions, tarragon, leeks, radishes, Jerusalem and other artichokes, and rhubarb; and also the following fruits, viz:—apricots, pears, apples, quinces, and pine apples. The duration of the action of the heated steam upon these substances

must be varied according to their nature and the purpose for which they are intended to be employed.

The method of packing will also vary according to the nature of the substances. For example, seeds (such as peas) may be packed in boxes of cardboard or wood, and vegetables in leaf are to be pressed in paper bags,—but care must be taken to secure them from the action of water, and to prevent them from getting damp.

As by this process the substances will have been already, to a certain extent, cooked by the action of the steam, when they are required for use, half an hour's cooking will be found sufficient to prepare them for the table, and bring them to the condition of fresh vegetables; whereas, under ordinary circumstances, unprepared vegetables of a similar description would require at least two hours cooking.

When meat is to be operated upon, it is to be deprived of bone and fat, and cut into pieces of about three inches in thickness by six inches in length, or the greatest length possible in the direction of the grain or fibres. The pieces thus prepared are then placed in the steaming apparatus, which is similar to that employed for vegetables, with this difference, that it is preferable to hang the pieces of meat upon hooks, instead of placing them upon frames. The steam is allowed to act for nearly a quarter of an hour, after which time the meat (all the albumen of which has become coagulated, and which has undergone a peculiar cooking action) is to be cut into slices as nearly as possible across the grain. A small quantity of salt is then sprinkled over these slices, and they are laid one over the other in a vessel, and allowed to remain during several hours, in order that the salt may penetrate them; after which they are to be dried in the same manner as described for vegetables.

When the preserved meat is only intended to be employed for the purpose of making broth or soup, the sprinkling with salt may be dispensed with; as the only object of this operation is to render the meat more tender and more easily acted upon by the water when required to be cooked for eating.

This mode of preparation will preserve meat for an indefinite time in a fresh state, so that broth prepared from such meat will have the great advantage of complete freshness; and the meat having been prepared without salt, the broth or soup made from it will not have that acrid and unpleasant taste incidental to products obtained by concentrating the juices of meat by evaporation or otherwise.

The pieces of meat when dried will be found to be hard,

brittle, and without smell, and may be kept for any length of time in casks or vessels; provided they be kept free from contact with water, or from exposure to too great a degree of humidity. In order to prepare the meat thus operated upon for the table, it is only necessary to soak it in lukewarm water, and to cook it slowly, in the same manner as when cooking fresh meat.

If it be desired to economize space in packing, as in provisioning ships or armies, the pieces of meat might be compressed on leaving the drying apparatus, and being then still warm, they would be soft and compressible, and only become brittle on cooling. By means of powerful hydraulic or other presses, cakes of any required thickness may be obtained, and which may be divided as required.

Thirdly, when fish are required to be preserved, they are to be treated as follows:—If small, or of moderate dimensions, they may be preserved entire, and for this purpose they must be gutted, and a small quantity of salt introduced inside them. They are then to be placed in the steaming apparatus, and submitted, during a very short period, to the action of heated steam, in the same manner as when operating upon meat, but for a very short time. They are then dried by the same means as those above indicated for meat and vegetables. When fishes of large size are to be operated upon, they may be cut up into pieces, sprinkled with salt, and dried in the same manner. Fish thus treated will be found to alter very little, either in form or size; they will keep well, and may also be prepared for table by boiling in water.

The patentees claim, preserving the animal and vegetable substances above mentioned, by submitting them to the double process of being operated on by steam, for the purpose of coagulating the albumen therein, and partially cooking the substances, and afterwards drying the same for the purpose of driving off or carrying away the watery particles.

---

*To CHARLES HUSTINGS COLLETTE, of Lincoln's-inn-fields, in the county of Middlesex, gent., for improvements in the manufacture of sugar,—being a communication.—[Sealed 2nd January, 1854.]*

THIS invention consists in an improved mode of treating cane-juice, molasses, beet-root-juice, and other saccharine juices and syrups, for the purpose of obtaining sugar therefrom, freed or separated from the impurities and other substances with which it is mixed.

It has been for some time known that the yield of sugar from cane-juice, molasses, beet-root-juice, and other saccharine juices, is smaller than it ought to be; and the cause of this small yield has been attributed to the use of a large quantity of charcoal (spodium) to clarify the syrup; whereby a considerable proportion of sugar becomes absorbed, notwithstanding the most careful manipulation; the molasses produced by many of the ordinary processes often containing nearly as much as 50 per cent. of crystalline sugar.

For the purpose of avoiding these evils the following process is employed:—The juices, molasses, or syrups (obtained by any of the usual means from the sugar-cane, beet-root, or other plants containing saccharine matters) are introduced into the defecation pan, together with the quantity of lime or lime-water necessary for producing defecation. About 30 or 40 per cent. of lime is sufficient for this purpose. As soon as the lime has produced the requisite effect upon the liquid, a sufficient quantity of superphosphate of lime is added to it, for the purpose of neutralizing the lime,—usually in the proportion of about 3 parts of the superphosphate of lime to 100 parts of the juice. The superphosphate of lime may be used at 4° Beaumé's hydrometer, or at any higher degree; and it is to be added as long as reddish litmus paper, dipped into the juice, is turned blue. Should too much superphosphate of lime happen to be added, this error can be rectified by the immediate addition of as much lime or lime-water as the superphosphate of lime in the solution will neutralize. The mixture will, by the above process, become thick and turgid, and must be filtered,—which may be done in the ordinary manner through filtering bags; and the filtered juice or syrup is then to be concentrated to 18° Beaumé,—when it will again become turgid or thickened. For the purpose of separating any impurities which may still remain in the juice or syrup, superphosphate of lime is again added, so long as litmus paper, dipped in the juice, is turned blue; after which the mixture is again passed through the filter; and the filtered fluid thus obtained must be concentrated, so as to produce the crystallation of as much sugar as can be separated in this manner; and the vacuum-pan and crystallizing tubs may be used in the usual way for this purpose. Sugar refined or purified in this manner, may be again dissolved or converted into syrup, and again submitted to the process, for the purpose of further purifying it.

The crystallized sugar, thus formed, is then to be separated in the usual way from the residual juice or syrup with which it is mixed.

From this residual juice or syrup a further quantity of sugar may be obtained by the following process:—The juices or syrups are diluted to about 28° Beaumé, with water, or with some sweet juice (the defecated juice of beet-root being preferred), and lime or lime-water is added; and about half as much as was used for the first process will generally be sufficient to produce the requisite defecation. Heat is then applied; and before the syrup boils superphosphate of lime is added until the syrup ceases to produce any apparent alkaline action upon the test-paper; and by these means the phosphate of lime will be precipitated. The syrup must then be filtered as before, for the purpose of separating it from its impurities; after which the filtered juice or syrup is to be concentrated and crystallized as before, for the purpose of obtaining from it a further quantity of sugar. Centrifugal machines may be used for separating the crystallized sugar from these juices or syrups.

The second residual syrup obtained by this last-mentioned process may also be subjected to the same process as that just described for treating the first residual syrup, in order to obtain, as results, a further quantity of crystallized sugar to be separated from a third residual syrup, as before.

In the same manner the process above described may be repeatedly applied to each residual syrup, which may remain, after a previous process, until the syrup or juice operated upon shall be exhausted of sugar, or as much so as may be economically practicable.

---

*To JAMES DILKS, of Nottingham, lithographer and embosser, for improvements in bands for binding more effectually than heretofore packets or parcels of lace and other articles.—[Sealed 23rd November, 1853.]*

THIS invention consists in the combination of cotton, linen, or any other textile fabric with paper, plain or ornamental, to be used as bands for binding or more effectually securing lace goods or other articles than is effected by the paper bands now in use; whereby lace goods and other articles may be secured against the damage or injury to which they are now liable, and to which they are frequently subjected by the breaking of the paper bands.

The manner in which the textile fabric is combined with the paper is by pasting or cementing the same thereto, either in sheets or in continuous lengths, as commonly practised in the mounting of maps and pictures.



The compound fabric, thus produced, whether plain or ornamental, is then cut into strips, or embossed and cut into strips in the manner practised in making paper bands; or cut into strips and then embossed.

The patentee claims the combination of cotton, linen, or any other textile fabric with paper, either plain or ornamental, for the manufacture of bands for binding packets or parcels of lace and other articles.

---

*To MARINO LOUIS JOSEPH CHRISTOPHE VINCENT FALCONI, of Paris, gent., for a certain composition for the preservation of the dead.*—[Sealed 7th November, 1853.]

THIS invention consists in combining certain vegetable and mineral substances, for the production of a powder to be employed in coffins containing the dead, for arresting decomposition and preventing the emanation of noxious liquids and gases.

The powder is composed of sawdust (by preference of common deal), previously well dried and sifted fine, or of other pulverizable vegetable matters, the least susceptible to decomposition, combined with a metallic salt, such as sulphate of zinc or iron, and pulverized camphor, mixed with another perfume, at option.

The proportion of sawdust should be, in general, about twenty to thirty pounds to about eight or ten pounds of pulverized metallic salt, and one ounce to one ounce and a half of pulverized camphor. Extract of benzoin, of lavender, balsam of tolu, or other perfume, may be added to the above ingredients; and, when combined, the whole will form a composition having absorbent and anti-putrid properties.

For bodies dead from epidemic or contagious diseases it is optional to add pulverized quick lime to the above ingredients, to accelerate their destruction.

This powder should be applied over all parts of the corpse, except the face and hands, when laid in the coffin; and it permits of a body being kept, before inhumation, without inconvenience, for a longer period than hitherto.

The patentee claims the combination of vegetable and mineral substances, as hereinbefore described, for the production of an absorbent and anti-putrid composition for the preservation of the dead.

---

To DAVID BLAIR WHITE, of Newcastle-upon-Tyne, Doctor of Medicine, for improvements in the manufacture of waterproof fabrics and of waterproof bags and other like articles.  
[Sealed 5th January, 1854.]

THIS invention has reference to the rendering canvas and other like materials waterproof, for any purpose to which it may be applied, but more especially for the manufacture of waterproof bags for containing liquids; and it consists in the production in or upon the material (whether made up into bags or not) of a compound which is insoluble in water, by the use of resin dissolved in coal-tar oil, or other suitable solvent, and of a metallic oxide, or of an alkaline earth, or of both a metallic oxide and an alkaline earth, and either with or without the addition, to the resin solution, of pitch, or a solution of India-rubber in naphtha, or in other suitable solvent, or of pitch and an India-rubber solution.

In carrying out this invention the patentee prefers to use the common dark resin of commerce, dissolved in the coal-tar oil, in the proportion of about two pounds of resin to five gallons of the oil; and, when pitch and India-rubber solution is employed, about one pound eight ounces of the pitch and four ounces of the India-rubber is added thereto. The canvas or material is steeped, for about five days, in either of these solutions; after which it is removed from the solution, and, while still damp, it is rubbed over with oxide of lead, or oxychloride of lead, or common lime, or else both the oxide and alkaline earth; such applications having the effect of forming a compound with the previous solution or application, which is insoluble in water, and having also the property of drying quickly. When dry, the operations are repeated, only varying the former by the use of a stronger solution, that is, of about five pounds of the resin to five gallons of the oil; and while the canvas or material remains damp, the oxide, or the oxychloride of lead, or the lime, or both the oxide and the alkaline earth, are again employed, and allowed to dry.

In the manufacture of waterproof bags they are first made up of the canvas or material, either before or after it has been prepared or partly prepared as above; and both the inside and the outside of the bags are treated with the last-mentioned strong solution of the resin, and with the oxide, or oxychloride of lead, or the lime, or both the oxide and the alkaline earth, so as to close and stop up the seams or joinings; and, in addition, a coating of a mixture containing pitch and India-rubber solution is given to the bags.

In order still more to ensure the waterproof character of the bags, and at the same time to render them repellent to the attacks of vermin (to which they might be liable when used for stowing water-ballast or liquid cargo in ships), and also to make them stronger and less liable to decay, they are covered externally with a strongly banded canvas covering, which is saturated with tar oil. The patentee remarks that, for common stowage purposes, he washes the interior of the bags with a strong solution of chloride of lime, or other soluble chloride; but when they are intended for cargo stowage, he lines their interior with thin sheet gutta-percha (as manufactured by the Gutta-percha Company); this material having been found not to deteriorate or injure the contents by imparting a flavor to them. Although the exterior lining, the washing internally, and the interior lining lastly above described, are recommended to be used, yet, having been practised with regard to bags hitherto made, they constitute no feature in the present invention.

---

*To JOSEPH FRY, of Cannon-street West, City, merchant, for improvements in preparing solvents for India-rubber and gutta-percha, and in rendering waterproof fabrics free from odour.—[Sealed 15th November, 1853.]*

THIS invention consists in dissolving India-rubber or gutta-percha in solvents before, and of introducing India-rubber or gutta-percha into the still when distilling or rectifying the solvents. And, in order to deprive waterproof fabrics of the odour consequent on the use of solvents, the fabrics are placed in a steam-chest and subjected to the action of free steam,—the upper parts of the steam-chest being coated with layers of flannel to prevent condensation.

In carrying out the first part of this invention, India-rubber or gutta-percha is introduced with the solvent into a still, and the solvent is then distilled over. From four to six ounces of India-rubber or gutta-percha (according to the state of impurity of the solvent), dissolved in each gallon, is found sufficient for the purpose: the distillation, in other respects, is carried on in the ordinary manner, and as is well understood. By this process the product, distilled over, will be found materially improved for the purpose of dissolving India-rubber or gutta-percha; and the residue in the still will be found useful for fabricating common or inferior articles, and for waterproofing coarser and lower-class cloths. The solvents usually employed for such purposes are turpentine,

and coal-naphtha or coal-oil; and either of these may be taken, in the crude state, and have dissolved therein India-rubber or gutta-percha, and be then distilled; or the crude solvent may be distilled first, without India-rubber or gutta-percha being present, and afterwards be combined with India-rubber or gutta-percha, and again distilled or rectified. The latter mode of treatment, it is believed, produces the best result.

The second part of this invention relates to the removal of the odour of articles fabricated of India-rubber or gutta-percha in which solvents have been used. For this purpose a close chamber is employed, its size depending on the quantity of goods or articles fabricated of India-rubber or gutta-percha in which solvents have been used, to be subjected to the process at one time. The patentee remarks, that it is desirable that the waterproof cloths, whether before or after being made up into garments or other articles, and other forms of waterproof fabrics, should be kept as open and separate as may be in order to admit as much as possible of the full and free action of the steam on all parts of the surfaces. The steam-chest or chamber should be of iron, with convenient doors at one end or side for the passage of persons to suspend or otherwise place the articles therein. The upper part of the chamber is open, but coated over with one or more coverings or layers of flannel, to partially restrain the passage of steam, and to absorb any steam which may condense thereon; and it is desirable also to line the whole interior with flannel, which should be dry at the commencement of the process. The steam is introduced at the bottom of the steam-chest or chamber by means of perforated steam-pipes, and the pressure of steam employed is only slightly above that of the atmosphere; but steam at a higher pressure may be used. By thus subjecting articles (whether made by the use of India-rubber or gutta-percha) to the action of free steam, the odour of the solvent used will be removed in a longer or shorter time, depending on the quantity of the odour of the solvent which remains in the articles.

The patentee claims, First,—the distilling solvents of India-rubber and gutta-percha with those matters present or combined therewith. And, Secondly,—the subjecting waterproof fabrics to the action of free steam to remove the odour thereof, as herein described.

---

To JOSEPH BENNETT HOWELL, of *Sheffield, steel manufacturer*, and WILLIAM JAMIESON, of *Ashton-under-Line, machinist*, for an *improvement or improvements in the manufacture of saws*.—[Sealed 25th July, 1853.]

THIS invention consists in the application and adaptation of a certain machine or combination of machinery or apparatus to the purpose of facilitating and perfecting the manufacture of saws.

One part of this machine consists in a punching apparatus, the punch and its die being of such a form as to punch or cut out the notches or spaces by which the teeth of the saw are formed. It is combined or not, as may be required, with a shearing or cutting apparatus, the action of which is to give a correct straight or curvilinear form to the edge of the plate of metal on which the teeth are to be cut.

Another part of the machine consists in the directing apparatus, by which fresh portions of the plate of metal are brought successively under the action of the punching and shearing apparatus. The punching and shearing apparatus is actuated by a cam or excentric on a revolving shaft, kept in motion by a steam-engine or other adequate power: whilst another cam, on the same shaft, gives motion to the directing apparatus,—the operation of punching or cutting out the notches, and moving forward fresh portions of the plate, taking place alternately.

A third part of the invention consists in the application of a rotatory file or files, by the action of which any roughnesses on the surface of the teeth of the saw are removed.

In Plate X., fig. 1, represents a side elevation of the improved machine for manufacturing circular saws; and fig. 2, is a plan of the upper part or table of the machine. A, A, are the two end frames or standards of the machine; A<sup>1</sup>, is a vertical cross-rail for connecting the two standards together; A<sup>2</sup>, the bottom cross-rail; and A<sup>3</sup>, the platform or table of the machine. B, B, is a headstock, which carries the hollow axis B<sup>1</sup>; and on this axis are mounted the fast and loose pulleys or riggers B<sup>2</sup>, B<sup>2</sup>, for receiving the band which gives motion to the machine. B<sup>3</sup>, is a fly-wheel at the outer end of the hollow axis B<sup>1</sup>, B<sup>1</sup>, for regulating the motion of the machine, and it is constructed so as occasionally to answer the purpose of a strap-pulley; c, c, is the punching headstock, which carries the mechanism for punching or cutting out the spaces or notches by which the teeth of the saw are formed; with which is also combined, when necessary, the cutting or shear-

ing apparatus. This punching headstock is shewn in fig. 8, where it is represented with the front plate removed, the better to shew the internal arrangement.  $c^1, c^1$ , is a shaft, having a longitudinal groove extending along nearly the whole of its length. This shaft slides through the hollow axis  $B$ , and is carried round with it by means of a feather or pin, which enters the longitudinal groove. By means of this contrivance, and a slot in the table or platform  $\Delta^3$ , the punching headstock  $c, c$ , can be placed in any position along the middle of the table (to suit the size of the circular saw to be manufactured), and clamped fast, by means of a bolt passing through the slot.  $c^2$ , is a cam or excentric, fixed on the shaft  $c^1$ , for actuating the slide  $c^3$ , which is provided, at its lower extremity, with a punch  $c^4$ , and the shearing tool  $c^5$ . These tools, when adjusted, are secured by means of set-screws.  $c^6$ , is a block on the frame of the headstock to receive the die, which corresponds to the punch  $c^4$ , and also the under shearing tool. The punch  $c^4$ , and its die are of such a form as to punch or cut out the spaces or notches by which the teeth of the saw are formed. The die and under shearing tool are adjusted and secured by means of set-screws.  $D, D$ , is a vertical shaft or axis, at the upper end of which is fixed the plate of metal which is to form the circular saw. It carries a ratchet-wheel  $D^1, D^1$ , which has as many teeth as there are intended to be in the circular saw to be made. This wheel is moved forward one tooth at a time, by the cam  $B^4$ , on the hollow axis  $B^1$ . For this purpose the cam gives motion to the lever  $B^5$ , on the vertical axis  $B^6$ , which has, at its lower end, the arm  $B^7$ . This arm gives motion to the lever  $D^2$ , by means of a connecting-rod  $D^3$ ,—the quantity of motion being regulated by means of an adjusting plate attached to the arm  $B^7$ . The lever  $D^2$ , carries the click or catch  $D^4$ , which takes into the teeth of the ratchet-wheel  $D^1$ , with which it is held in contact, by means of a spring.  $D^5$ , is another click or catch, which also takes into the teeth of the ratchet-wheel  $D^1$ , which it secures or retains each time the wheel is moved forward by the action of the cam  $B^4$ . The catch  $D^5$ , is held in contact with the ratchet-wheel by a spring, and turns on a centre secured to the cross-rail  $A^1$ . The ratchet-wheel  $D^1$ , and the mechanism connected with it, are, for the most part, shewn by dotted lines in fig. 2.  $D^6$ , is a friction-pulley fixed on the vertical axis  $D$ . This pulley is embraced by the friction-brake  $D^7$ , composed of two straps of metal, connected together by two screw bolts; by means of which the friction of the brake on the pulley is regulated. One end of one of the straps is elongated so as to

form an arm or lever  $D^8$ ; to the end of which is attached the spring  $D^9$ , provided, at its opposite end, with a tightening screw, which passes through a lug attached to the under side of the platform  $A^3$ . The amount of friction of the brake  $D^7$ , and tension of the spring  $D^9$ , being regulated as described, the action is obviously to hold the ratchet-wheel  $D^1$ , firmly against the catch  $D^5$ , at the time when the cam  $B^4$ , is drawing back the catch  $D^4$ , in order to engage a fresh tooth of the ratchet-wheel. As the ratchet-wheel is moved forward the spring  $D^9$ , becomes tightened until its tension is sufficient to overcome the friction of the brake on the pulley  $D^6$ ; the brake then slips on the pulley, and the tension of the spring is diminished, until it is again tightened by the action of the cam  $B^4$ , on the ratchet-wheel  $D^1$ .  $D^{10}$ , is the plate of metal which is to form the circular saw. It is firmly held between the two plates  $D^{11}$ , and  $D^{12}$ , which revolve with the vertical axis  $D$ . The punching headstock  $C, C$ , is fixed in such a position that the punch  $C^4$ , and shearing tool  $C^5$ , are enabled to act upon the edge of the plate  $D^{10}$ , which has been previously brought to somewhat near a circular form. It will be seen that the cams  $C^2$ , and  $B^4$ , are placed in such positions, with respect to each other, that when the cam  $C^2$ , is forcing the punch  $C^4$ , through the plate of metal, the cam  $B^4$ , is in the act of drawing back the lever  $D^3$ , to enable the catch  $D^4$ , to take hold of or engage a fresh tooth of the ratchet-wheel  $D^1$ ; and that, when the cam  $C^2$ , by its reverse action, has withdrawn the punch  $C^4$ , clear of the plate of metal, the cam  $B^4$ , re-acts on the catch  $D^4$ , and, consequently, moves forward the ratchet-wheel  $D^1$ , one tooth. By this means a fresh portion of the plate  $D^{10}$ , is brought within range of the action of the punch  $C^4$ , and the process is repeated as before, and continued until the teeth are formed all round: the saw being then complete, it is removed, and a fresh plate is substituted in its place.

Fig. 4, represents the adaptation of the invention to a machine for manufacturing reciprocating or straight-edged saws, the cutting edges of which have a straight or curvilinear form.  $E, E$ , is a bed-plate fixed on the platform  $A^3$ , and on which slides the sliding-plate  $E^1$ . Attached to this sliding-plate are two plates  $E^2, E^2$ , between which is firmly held the plate of metal  $E^3$ , which is to form the saw. The two plates  $D^{11}$ , and  $D^{12}$ , are removed from the top of the vertical axis  $D, D$ , and the pulley  $D^{13}$ , substituted in their place. One end of the chain  $D^{14}$ , is attached to the pulley  $D^{13}$ , and the other end to the lug  $E^4$ , fixed to the sliding-plate  $E^1, E^1$ . Under-

neath the sliding-plate  $E^1$ , and at the opposite end, is attached a cord or chain, which passes over a pulley fixed in an aperture in the bed-plate  $E$ ,  $E$ , and platform  $A^3$ , and thence downwards, having a weight attached to the end. The operation of the weight is obviously to act against or pull the chain  $D^{14}$ , and, consequently, in proportion as the chain is coiled on the pulley  $D^{13}$ , the weight is raised. The effect of this arrangement is therefore to cause the sliding-plate  $E^1$ , and also the two plates  $E^2$ ,  $E^2$ , and plate of metal  $E^3$ , to have a forward motion corresponding to the circular motion of the pulley  $D^{13}$ . The front edge of the plate  $E^1$ , is straight or curved (according as the cutting-edge of the saw is straight or curved), and bears against two pins or studs on the bed-plate  $E$ ,  $E$ . The back edge of the plate  $E^1$ , or that next to the pulley  $D^{13}$ , is pressed upon by a friction-roller on a lever  $E^5$ , which turns on a centre on the bed-plate  $E$ ,  $E$ ; and at the opposite end of the lever is a tightening screw, which acts on the lever through the intervention of a worm spring. By this means, the front edge of the sliding-plate  $E^1$ ,  $E^1$ , is kept in contact with the two studs before mentioned, whilst at the same time a free motion endwise is permitted. The arrangement of the vertical axis  $D$ ,  $D$ , and the ratchet-wheel  $D^1$ , is the same as already described; it being observed that the number of teeth in the ratchet-wheel  $D^1$ , and the diameter of the pulley  $D^{13}$ , must be so regulated as to give the proper number and pitch to the teeth of the saw to be manufactured. Also, if it be required that the pitch of the teeth should vary betwixt the two ends and middle of the saw, this may be effected by making the pulley  $D^{13}$ , more or less excentric. With this arrangement the friction-pulley  $D^6$ , may be dispensed with; the other parts of the apparatus remaining the same as before described. The punching headstock  $C$ ,  $C$ , being fixed so as to allow the punch and shearing tool to act on the edge of the plate of metal  $E^3$ , the ratchet-wheel  $D^1$ , is turned backwards, and the sliding-plate  $E^1$ , has in consequence a corresponding movement given to it by the descent of the weight before described. When it has been carried so far back as to bring that part of the plate  $E^3$ , where the teeth are to commence, under the punch and shearing tool, the ratchet-wheel  $D^1$ , is secured by the catch  $D^5$ . The hollow axis  $B^1$ , being now put in motion, the plate  $E^3$ , is carried forward, and the teeth formed in the same manner as already described in the case of the circular saw. When the whole of the teeth are finished, the saw is removed, and a fresh plate being substituted in its place, the operation is repeated as before. The



patentees remark, that they do not confine themselves to the use of the ratchet-wheel  $D^1$ , as other means may be employed to answer the same purpose. For instance, they sometimes substitute a worm-wheel, which is acted upon by a worm combined with change wheels or pinions (by which the fineness or pitch of the teeth of the saw is regulated), and a small ratchet-wheel which is put in motion by the cam  $B^4$ . Neither do they confine themselves to the use of the pulley  $D^{13}$ , and chain  $D^{14}$ , as the same end may be attained by using a rack combined with a toothed wheel or wheels. Neither do they confine themselves to the use of two cams or excentrics, as one cam may be arranged so as to actuate the punch and shearing tool, and also to give motion, at the proper time, to the directing apparatus. Neither do they confine themselves, in the case of reciprocating saws, to the use of the vertical shaft  $D, D$ , and its appurtenances, as they sometimes use a directing apparatus of the following construction instead:— A series of ratchet-teeth is formed on the back edge of the sliding-plate  $E^1$ , and two clicks or catches are arranged so as to take into these ratchet-teeth, and retain the sliding-plate  $E^1$ , alternately; the direction of the ratchet-teeth being such that the action of the catches will prevent the forward motion of the sliding-plate. The weight with its band or chain (before described) is retained, but its position and action on the sliding-plate is reversed, so as now to press the sliding-plate forward, and so to hold it firmly against one or other of the catches, as the case may be. When the machine is at work, the catches are lifted alternately, by means of a cam provided for that purpose; the sliding-plate moving forwards when one catch is lifted, until it is retained by the other; and in consequence fresh portions of the plate of metal are brought successively under the action of the punching and shearing apparatus before described.

The next part of the invention consists in the application of a rotatory file or files, for the purpose of removing the roughnesses, and filing up the teeth of saws used in saw gins, for ginning cotton, and other saws which require to be treated in a similar manner. The construction and application of these files will be understood by reference to figs. 5, and 6; fig. 5, being a plan, and fig. 6, an end view of two rotatory files, as arranged and adjusted when in operation on the teeth of the saw;  $G, G$ , is a portion of a saw-plate, in which the teeth are partially cut (shewn in section in fig. 6.).  $G^1$ , is a rotatory file, which acts on the upper side of the saw-plate; and  $G^2$ , is another rotatory file, which acts on the lower side of the saw-

plate. The form of these rotatory files is similar to that of two frustrums of cones, the bases of which are placed together, forming an angular edge all round, from which the bevel or slant surfaces slope both ways. On these slant surfaces the file teeth are cut all round, the form of the surfaces being such that, while one of them removes the rough edge or arris from the back of one tooth, the other removes it from the front of the next. The action of the two rotatory files is simultaneous; the rough edges of the upper side of the teeth being removed by the upper file, and the rough edges of the lower side of the teeth being removed by the lower one. It will be seen that the two rotatory files cannot operate in the same space or notch between the saw-teeth at the same time, but are placed so as to operate in notches a tooth or two distant one from the other.  $G^3$ , is a shaft on which the rotatory file  $G^1$ , is fixed; and  $G^4$ , is a shaft on which the rotatory file  $G^2$ , is fixed. These two shafts are geared together by means of toothed wheels, so as to operate both at the same time, and are fixed in a frame which turns on a centre or swivel. To this frame, and consequently to the rotatory files, a vibratory angular motion is given, by means of a cam. When the files have removed the roughnesses from the edges of the teeth with which they are in contact, they are withdrawn clear of the saw, by the action of this cam. The saw is then moved forward the space of one tooth, by means of the directing apparatus; which being done, the rotatory files are each re-inserted in fresh spaces or notches, and the operation is repeated as before, and this is continued until the roughnesses are removed from every tooth of the saw. When the rotatory files are combined with the machine shewn in figs. 1, and 2, they are arranged so as to operate at the same time as the punching and shearing apparatus. When the punch and shearing tool are raised so as to clear the plate of metal, the rotatory files are withdrawn at the same time, so as to allow the plate to be moved forward the space of a tooth, as before described. In this case, the rotatory files may be actuated by means of a band from the fly-wheel  $B^3$ , and, as they are brought into action simultaneously with the punch and shearing tool, the same cam may be made to actuate both. But it is obvious that the rotatory files and their appurtenances may be arranged so as to constitute a separate machine, if required.

The patentees claim, First,—the application of the punching headstock  $c, c$ , in combination with the directing apparatus (that is, the vertical shaft  $D, D$ , and its appurtenances), as applied to the manufacture of circular saws, as set forth and

described. Secondly,—the application of the punching head-stock, c, c, in combination with the directing apparatus (that is, the slide E', E', in connection with the vertical shaft D, D, and its appurtenances, or the substitute or substitutes for the same), as applied to the manufacture of reciprocating saws, as set forth and described. And Thirdly,—the application of rotatory files for the purpose of removing the roughnesses and filing up the teeth of saws, either in combination with the other parts of the mechanism, or as a separate machine, as set forth and described.

To JOHN CHISHOLM, of Holloway, practical chemist, for improvements in the production or manufacture of artificial manures.—[Sealed 4th June, 1853.]

THIS invention consists in treating animal bodies so as to destroy their organic structure, and arrest and secure the gases evolved in such operation. The patentee also treats certain vegetable substances by a similar method to that adopted for animal bodies; or he mixes the animal and vegetable bodies together previous to their being acted upon as hereinafter described: and he also makes use of certain mineral substances for perfecting the operation.

The invention applies to the treatment of all animal bodies. Fish is to be used either entire or in parts. It will be obvious that in certain situations, where a regular demand for animal food exists, the offal of animals only can be profitably used,—such as the refuse of slaughter-houses and fish-markets, blood, gut, skin, bone, or other similar parts. The vegetable substances made use of are, firstly, sea-weed (that kind called laminaria being preferred, from its richness in the salts of potash). Secondly,—turf or peat: this may be either the common peat or that description found in many localities impregnated with sulphate of lime, iron, or copper, or peats combined or saturated with peroxide of iron. Thirdly,—charcoal, made from any vegetable body, or from shale. The minerals used in carrying out this invention are shale, clay, coal, decomposed granite, iron pyrites, shells, lime and magnesia, and their salts, coprolites, ouse, chloride of sodium and potassium, and their nitrates, sulphate of iron, and the mineral acids, such as sulphuric, hydrochloric, and nitric.

The figure in Plate IX., shews the kind of furnace used in carrying out the invention. To the end of the furnace an apparatus is attached, similar to that used by the manufacturers of gas from coal; the arrangement being the same, with this

exception, that the furnace is made use of instead of a retort. The apparatus consists of a refrigerator, purifying vessels, and a gas-holder. The fire-chamber *a*, of the furnace is filled with coke from the hopper *b*. The chamber *c*, is filled to about two-thirds of its cubic contents with sea-weed or turf, or a mixture of both: the chamber *d*, is filled in a similar manner with animal bodies. If it be fluid (such as blood), it may be mixed with ground peat. The doors *f*, and *g*, by which the chambers *c*, and *d*, were filled, are now to be closed and luted. The dry purifier is to be filled with ground peat or charcoal, which is naturally, or has been artificially, impregnated with a sulphate of lime, iron, or copper. Or this dry purifier may be charged with the following preparations:—Take the carbon that has been removed from the chamber *d*, of the furnace, and digest with half its weight of sulphuric acid which has been diluted with three times its weight of water: this will convert the phosphate into a superphosphate of lime. If it should be too moist to be placed alone in the purifier, it may be mixed with peat or charcoal in powder. The wet purifier is to be charged with a solution of chloride of potassium and lime, or a solution made by mixing the burnt ashes of laminaria with water, or a solution of chloride of sodium: this wet purifier has an agitator, which must be kept in motion during the operation. All being now charged, every opening is to be securely closed and the fire lighted. The hot or cold air-blast is now set in motion, and will pass into the furnace by the pipe *e*, and, in its passage through the column of red-hot fuel, will have its oxygen consumed; and the highly-heated azote and carbonic oxide, in its passage through the chamber *c*, will carbonize the vegetable peat and algae, producing various gases. These, still in a highly heated state, pass on to the chamber *d*, and in a similar manner act upon the animal bodies, from which gases are also evolved. All these gases, mingled together, enter the refrigerator, where the aqueous and tarry matters are deposited; and the lighter gases pass first through the dry purifier, where any ammonia that has escaped condensation will be arrested by the sulphuric acid contained in the peat. The gases now pass, free from ammonia, into another dry purifier filled with peat containing peroxide of iron, so as to decompose sulphuretted hydrogen: from this the gas passes into the wet purifier; and thence into the atmosphere, or into a suitable receiver. At the end of the refrigerator there is a tap for testing the gas previous to its entering into the purifier. If the gas at this tap does not stain turmeric paper brown, the operation is at an end, and the blast should be stopped. The con-

tents of the chamber *c*, will now be a vegetable carbon, rich in alkalis: that of the chamber *d*, will principally consist of phosphate of lime, and a rich animal carbon. The ammonia from the purifier may be used, combined with the charcoal as taken from the vessel, or the ammonia may be washed out and converted into a salt of ammonia in the usual way; and the material from the sulphur purifier, when loaded with sulphur, may be converted into sulphuric acid, or the sulphur may be sublimed from it. The contents of the last purifier are filtered and crystallized in the usual way.

In the tank at the condenser will be found tar and water; the latter being strongly impregnated with the salts of ammonia, principally in a state of carbonate and sulphide. This liquid may be filtered by the mode demonstrated by Mr. William Chisholm, when treating of the ammoniacal liquor of gas-works, in the specification of his patent, dated 21st May, 1853; or it may be treated with sulphuric or hydrochloric acids, or in any of the various modes practised by ammonia manufacturers. When the desired salt of ammonia has been made, such as a sulphate or hydrochlorate, it is to be mixed with the animal and vegetable carbon, so as to produce a mixture of any given strength of ammonia, phosphates, and alkalis. Another mode of accomplishing the same end is by destructive distillation in close vessels; such vessels may be in any form, and made of iron or clay: a very convenient form is that now used at gas-works for the distillation of coal. The retorts are set in brickwork, in what are called ovens; there being three or five retorts in an oven. If three be used, one should be charged with algæ or bituminous shale, another with peat; and the third with animal bodies; the animal substance being always placed furthest from the fire. The *modus operandi*, after leaving the retorts, is precisely the same as already described, when leaving the furnace; and the products will be treated in a similar manner. The gas arising from the retort process is of a high illuminating quality, and may be stored away for any useful purpose. Where there is a quantity of animal substance readily decomposed by heat (such as blood), it is preferred to place it in a retort cold set, that is, without being exposed to heat. The highly-heated gases from the retorts charged with the peat and algæ, and the more solid animal matter (such as hoof or bones), is made to pass through this cool set retort, so as to pass over the blood before ascending the stand-pipe and entering the hydraulic main; the object being to liberate the nitrogen with as little heat as possible. Peat may be used without sea-weed, or sea-weed with-

out peat; or either or both of them may be mixed with the animal bodies before submitting them to heat; or animal bodies may be used alone in either of the processes. Both in the furnace and retort operation it is desirable to have a spare dry and wet purifier, so that the gas may be turned into a fresh-filled purifier, should either of the purifying materials become exhausted during the operation. For instance, suppose there are three dry purifiers, numbered respectively 1, 2, and 3. No. 1, takes up the ammonia; No. 2, the sulphur; and No. 3, is empty: each purifier has a stop-cock attached, for the purpose of testing the gas that has passed through it. Upon the application of turmeric paper to the cock at No. 1, if it becomes stained brown it shews the presence of ammonia, and that the material that arrested the ammonia has become saturated. It becomes therefore necessary to fill No. 3, with peat or charcoal, saturated with the requisite material already described for taking up the ammonia, and to turn the gas from No. 1, to No. 3. If a piece of white paper moistened with a solution of acetate of lead becomes black when exposed to the stop-cock of purifier No. 2, it shews that sulphuretted hydrogen is escaping. No. 1, should then be charged with the peat or peat charcoal, impregnated with peroxide of iron, and the gas turned from No. 2, to No. 1. The peroxide proportion may be used many times, by merely exposing it to the atmosphere to peroxidize the iron, or by leaving it in the purifier, and passing through it a current of air moistened with steam. Peat or peat charcoal, as is well known, absorbs offensive gases from decomposed animal bodies: this is, however, a mere mechanical mixture; the offensive gases being again given up upon being exposed to the rays of the summer sun,—tainting the atmosphere, and spreading disease; but by the processes herein described, they remain in the soil as food for plants.

Many parts of the coast of Great Britain and Ireland are periodically visited by vast shoals of fish, quantities of which are thrown upon the beach, and taint the atmosphere for miles. To secure these, and prevent the escape of the injurious gases, the patentee adopts the following process:—A circle is made on the ground, say 25 feet in diameter; the earth is removed so as to make the ground incline in all directions towards the centre; a round cavity is dug out of the centre, about 9 inches deep and 18 inches over; and from this a gutter is formed, ending in a tank or sunk cask, placed beyond the circle line. The centre hole and gutter are lined and covered with slate or any convenient material; and serve to conduct the drainage from the decomposing animal bodies to the tank. Dried peat

or turf, strongly saturated, either naturally or artificially, with a sulphate of lime or a sulphate of iron, or a chloride of calcium or chloride of sodium, is to be spread over the entire base to the depth of 2 feet: a wall 2 feet high and 3 feet thick at the base gradually sloping inwards, so as to be 2 feet thick when 2 feet high. Where turf is not readily obtained near the sea-shore, sea-weed and mud or sand are to be used. Into the inner circle are thrown the fish, until level with the top of the turf wall. The top of the fish is covered with a similar turf to about 6 inches deep: another and similar turf wall is again built all round, and the space within filled as before with fish: this is repeated so as to form a cone. If the diameter of the base is 25 feet, the summit should be about 10 feet. The entire outside of the cone is to be covered with a light porous peat, impregnated with peroxide of iron. This mound may be allowed gradually to decompose; the ammonia evolved will be absorbed by the sulphate or chloride peats, and converted into a sulphate or hydrochlorate of ammonia; while the sulphuretted hydrogen, forcing its way through the walls of the sulphate peat, will be decomposed in its passage through the peroxide peat—depositing its sulphur and forming a protosulphuret of iron. This protosulphuret is almost instantaneously oxidized by the atmosphere, and again converted into a peroxide; and this play of chemical affinities will continue as long as sulphuretted hydrogen is evolved. The walls, previous to applying the peroxide peat, may be plastered over, where obtainable, with rich ouse, obtained from salt marshes or beds of rivers: they may also be occasionally damped with sea water. Such mounds will form a magazine of material to be acted upon by either the furnace or retort process hereinbefore described, at leisure. The animal bodies, either mixed with the turf and sea-weed, or either of them, may be decomposed in an oven, similar to that used for making bone black. Where mounds are made or used, it is advisable to have another small mound made beside them, about a fourth of the size, and formed of sulphate peat: the two mounds are to be connected by pipes, so that the smaller may absorb any ammoniacal gases that might be evolved from the larger. The animal and vegetable substances might be piled in small mounds on the beach, and at once submitted to a rude process of charring or distillation. The animal bodies with the sulphate peat, with or without the sea-weed, may be intimately mixed together by any mechanical means. This mass may be formed into bricks or blocks, and dried in the open air, or in a kiln, or exposed to a current of hot air, and

may be stored away (to be operated upon, at leisure, by the furnace or retort), or ground into powder for manure. The peat may be saturated with a solution of chloride of sodium; then mixed with about its own weight of any animal matter, blood, gut, or fish. When intimately mixed, add lime (about a third the weight of the mixture) to the damp mass, and form it quickly into blocks or bricks of any convenient size; and, upon the lime being added, heat will be generated, and the mass will become hard. These blocks may be stored in a dry place; a chemical change will gradually take place; and after a lapse of months they will be found to consist of nitrates and hydrochlorate of soda, ammonia, and phosphates. The various minerals and mineral acids above enumerated, are made use of according as local circumstances may require. Where peat cannot be obtained, the locality may supply shale, or schists, which is substituted for peat; or the locality may have plenty of peat, but not impregnated with sulphate of iron: in such case heaps of iron pyrites are placed on various parts of the bog, and by the joint action of the atmosphere and moisture, the pyrites are decomposed, and a sulphate of iron is formed, which saturates the surrounding turf. Solutions of mineral sulphates issue out of the soil in many localities, and are also pumped out of mines: such solutions may be absorbed into peat. When turf has been saturated strongly with a solution of sulphate of copper (which may be done by repeatedly drying and saturating), it may be sold for the value of the metal it contains. All the animal offal of towns may be mixed with the peats or charcoals described, on the spot where such offal is produced,—such as fish-markets and slaughter-houses. The peats will at once absorb the offensive gases evolved by any partial decomposition which might take place prior to the removal of the offal to the manufactory, where it will undergo one of the processes already described, either by furnace or retort.

---

To WALTER HENRY TUCKER and WILLIAM RASHLEIGH REEVES, both of Tiverton, in the county of Devon, for improvements in locks.—[Sealed 21st November, 1853.]

THE first object of this invention is the construction of locks in such manner that access through the key-hole to the moveable combination parts shall be impossible while the opposing piece (*i. e.*, the piece which prevents the bolt being unshot, unless the combination parts be correctly arranged) is in contact with them; and to effect this closing up of communication



with them, and to complete the process of unlocking with one operation of the key; so as to prevent the necessity either of having two external key-holes, through one of which to adjust the combination parts, and through the other to give the required motion to the bolt, or of using a handle to throw the bolt, after adjusting the combination parts, through a single key-hole: or, lastly, of resorting to the expense and complication of triple sets of combination parts by which to effect the purpose. This improvement is accomplished by surrounding the combination parts by a moveable box or enclosure (which may be made of any suitable shape, such as round, square, oblong, &c.), the sides of which stand at right angles with the plates of the lock, and reach the whole depth of the lock. The box has a flat seat to it, perpendicular to its sides. In the side or sides of the box, above the flat seat, are two slots or gatings, through which only can communication be obtained with the combination parts. Through one of these gatings, termed the true or internal key-hole, the key-bit must pass, to adjust the combination parts to position: into the other, the opposing piece or stump must enter before it can reach the combination parts; and as it is only when both gatings are carried behind or inside a solid shield or safe-guard (fixed to the frame of the lock), so that no access to them through the external key-hole is possible, that the opposing piece and the combination parts can be brought into contact, it is manifest that communication with them during such contact is a mechanical impossibility. The requisite motion is given to the surrounding box by a part called an "auxiliary key-bit," which is attached to a socket surrounding the drill-pin, and reaching the whole depth of the lock, and into which the key fits, and carries it with it in its revolution. The drill-pin or axis of the key is fixed beyond and without the line of action of the moveable box; the talon of the bolt upon which the bit operates being still further beyond it. The action is thus:—The key is placed in the lock and turned, carrying the auxiliary bit with it: the key-bit first passes into the internal key-hole in the side of the box, adjusting the combination parts to position; a simultaneous movement being given to the box. The action of the key being pursued, it then passes out of the internal key-hole; the auxiliary bit continuing the movement of the box, and carrying the internal key-hole within or behind the fixed shield or safe-guard, so that no communication with the combination parts can be effected; by which time, and not until then—the second gating in the side of the box being brought into a line with the opposing piece—the bolt can be drawn

back. It should be stated, that the primary action upon the moving box, and the action upon the bolt-talon, can be effected either by the key or by the auxiliary bit, both of which means are used. The socket of the auxiliary bit is made to fit and revolve upon a pipe-shaped metallic spring, attached to the under part of the surface-plate of the lock around the key-hole, and is so made to fit as to prevent the looseness and unsteadiness which must necessarily result if the pressure of the lock-plates upon the ends of the socket were the only means of keeping it steady to its work.

By the foregoing description it will be seen that the rim of the enclosing box will only admit the opposing stump through it when the gatings are closed to communication from the external key-hole. When the bolt is locked out, the solid portion of the base of the rim being passed behind the bolt, preserves the lock from violation or injury by any force applied to the bolt.

The patentees claim, under the first head of the invention, First,—the application to locks of a moveable box or enclosure, surrounding the combination parts, and cutting off all communication with them from the external key-hole, during the time the opposing piece is or can be in contact with them; and part of which box, by passing behind the bolt, when it is locked out, shall preserve the lock from injury by force applied against the bolt. Second,—the application to locks of an auxiliary key-bit (acted upon by the key) serving to operate upon the moveable box, so as to complete the closing up of communication with the combination parts when the opposing piece is or can be in contact with them, and which auxiliary bit may be used to propel the bolt. Third,—the application to locks of a pipe-shaped metallic spring, fixed to the back of the surface-plate of such locks around the key-hole, for the purpose of keeping the auxiliary bit steady to its work.

The second object contemplated by the present improvements is, the construction of such portions of the combination parts of locks as the key-bit impinges upon, in such manner that no indication can be obtained (either by the wear of such parts, or by smoking them through the key-hole) of the length of action of the key upon them, so as to make false keys to such locks. The arrangement which effects this constitutes the fourth claim, and is as follows :—The combination parts (which are flat pieces of metal, of any suitable shape, as round, square, oblong, &c., and are ranged one over the other, with their plane surfaces parallel with the lock plates) have cut in each at its outer edge a notch, upon the side of which the key-bit

impinges, carrying each to a distance according with the length of the key-bit acting upon it. And the improvement consists in so shaping that notch that it shall be so much larger behind than at the opening where the key-bit enters, that the bit can impinge only on the outer edge of the opening; so that, whether the step of the key-bit acting upon it be either long or short, the impression it makes on the smoked edge of the notch will, in each case, be the same.

In the construction of small locks, in order to render them stronger and more durable than can be the case with the cast plates used in the construction of other locks, the plates are made of rolled or drawn metal, which, from its superior density and hardness, enables the locks to resist attempts at injury or violence more effectually.

Spring locks on this construction are made with a spring-bolt stump, which yields, so as to allow the bolt to recede on closing the lock, but is so arranged, that the bolt cannot be drawn back from the key-hole without the true key.

Padlocks are constructed by attaching the combination stump to the tail of the shackle,—thus doing away with a bolt; the stump (after the combination parts are arranged by the key) being passed into their gatings by opening the shackle.

These improvements are applicable to locks for all purposes and of all sizes.

---

### **Scientific Notices.**

#### **INSTITUTION OF MECHANICAL ENGINEERS BIRMINGHAM.**

*(Continued from p. 297.)*

The following paper, by Mr. ARCHIBALD SLATE, of Dudley, was next read:—

*“On a safety apparatus for working mine-shafts.”*

The safety apparatus described in this paper is the invention of Mr. William England, of Dudley, whose attention has been directed for a long time to the insecurity of the ordinary mode of raising men engaged in mining operations. The breaking of machinery and running of the chains and ropes are accidents to which the miner is constantly exposed, and for the prevention of which no effectual mode has hitherto been successfully adopted; the machinery suggested for that purpose being either so cumbersome or complex as to offer serious impediments to its practical

utility—did not the expense present an insuperable barrier to its general adoption.

Mr. England's invention is intended to supply perfect safety in all cases of ascending and descending, by simple and economical means.

The apparatus consists of a square tube, which runs down the shaft, and is formed of two pieces of deal or other wood for the sides, 3 in. thick by 10 in. wide, united at the back by a piece of wrought iron, or hard wood, or a combination of both, one foot in width, strongly bolted to the side pieces. On the front of each of the side pieces is fixed by screws a strip of wrought-iron,  $5\frac{1}{4}$  in. wide and  $\frac{3}{4}$  inch thick, leaving an opening in the centre,  $1\frac{1}{2}$  in. wide, the entire length of the tube.

In this tube is a piston, formed of two pieces of hard wood, with a space left in the centre to receive the parallel motion bars connected with the outer frame or bracket, which supports the stage or moving platform. Inside the tube is a chain, attached to an iron arm fixed to the platform, for raising and lowering the same. Two friction-bars of wood, outside the square tube, one on each side, 9 in. wide and 3 in. thick, are connected, by parallel motion bars and joints, to the piston, which parallel motion bars are carried on to the centre support for the platform.

The effect of the chain snapping is to create friction between the front plate of the tube and the piston and friction-bars, and thereby to stop the platform in its descent,—the quickness of the action and amount of friction being determined by the weight raised: and it is an important advantage that the chain cannot descend into the pit, but it is always retained in the tube; thus obviating the necessity of bonnets and strong unwieldy cages for the protection of the men. At the same time lighter chains may be advantageously substituted; which, from these chains being retained in a uniform position whilst at work in the tube, and not being subjected to the rotary and twisting movements by which they are now tried, must tend considerably to their preservation.

For shafts out of the perpendicular, where ordinary guides cannot be used, this invention is well adapted,—the tube being sufficient to insure steady working; and, where applied, it must effectually prevent the loss at present arising from the quantity of coal broken by oscillation and contact with the sides of the shafts.

The weight of the stage, bracket, and piston, is estimated by the inventor at about 7 cwt., the cost of applying it at not more than 15s. per yard, and the annual expense of working at less than five per cent. upon the outlay. When the saving effected in the repairing of the shaft and the loss from slack made by the present mode of raising is duly estimated, considerable deductions have to be made upon these calculations; but whatever be the pecuniary advantages arising therefrom, the main

object of the invention is the security of the miner in his hazardous employment.

Mr. England exhibited a working model of the apparatus, and shewed its action. He observed that the apparatus was very simple, with no expensive materials or workmanship, and that it had been a particular object to keep it free from any objection of complication or difficulty of repair. The pitman could easily do the repairs that might be required, and all the material made use of was ordinary bar-iron and timber, all of which would come in for other purposes.

The Chairman observed, that there had been many ingenious plans invented for the purpose of increasing the safety of working pits, but this plan had one advantage over others, which appeared deserving of consideration,—in keeping hold of the chain during the whole descent, to secure it from falling into the pit in case of breaking. In the ordinary plan there was, perhaps, more risk of accident to the men, from the chain breaking and falling on their heads when near the bottom of the pit, than from the actual falling of the men; although strong bonnets were employed to shelter them.

In answer to an enquiry, Mr. England said he proposed to cover up the front of the groove by an iron plate sliding with the platform, and long enough to prevent anything from falling into the groove. He did not see that any difficulty was to be anticipated from obstruction in the groove, as the passage of the piston through it each time would keep the whole clear; and it was intended that the piston should fit quite loosely, so as not to leave any liability to get jammed.

Mr. G. Thompson thought that the constant friction of the piston against the side of the tube would be very serious, from the overhanging weight of the platform, and would cause great wear, as well as a liability to interfere with the regular working of the platform. The platform and piston acted as a bent lever; the point of suspension being the fulcrum; and a portion of the weight of the apparatus and the load, in proportion to the leverage, would therefore act as a constant pressure upon the side of the piston, through the whole time of ascending and descending; and with a heavy load on the platform the friction might actually stop it in descending.

Mr. England said that a friction-roller was fixed at the bottom end of the piston, to roll up and down against the back of the tube, where the whole pressure would take place, and to prevent the piston from rubbing against the tube. The length of the piston was intended to be considerably greater than the projection of the platform, to diminish the leverage at which the weight acted, and reduce the pressure on the friction-roller accordingly. A second roller might also be fixed on the front of the piston, at top, if considered desirable.

Mr. Thomson remarked, that friction-rollers were liable to stick fast, and there would be much difficulty in keeping a roller in working order in such a situation; and he thought it possible that the pressure might be so great, from a heavy load on the platform, as to prevent the roller from turning, and that the friction would be liable to stop the descent of the platform when not desired: but under any circumstances the roller only mitigated, and could not remove the objection. He did not consider that a provision was required for guiding the rope in case of breaking, as the cases of accidents from breakage of the rope were very few, in his experience, and the ordinary plan of an iron bonnet over the platform he thought was a sufficient protection for the men. He preferred a light wire rope to a chain; and this, in case of breaking, did not fall with force enough to injure a tolerably strong bonnet. The wire rope, in falling, he had observed, did not fall straight down, like a chain, but took a cork-screw form round the shaft.

---

The following paper, by Mr. ROBERT JOBSON, of Dudley, was next read:—

*“On an improved construction of moulds for casting metals.”*

The subject of this paper is the invention of Mr. John Jobson, of Derby, and may perhaps be considered as one of the results of the difficulty experienced in the labour market. This invention consists of a mode of constructing the moulds for metal castings, by means of which the process of moulding is simplified, and an important economy effected in the cost and time of moulding; also the accuracy and perfection of the moulds is increased, so that the castings produced have less “fin” or other irregularities than usual, and greater uniformity is insured in running the metal, than in the ordinary method of moulding, reducing the proportion of “wasters.”

The advantages of the new plan are most felt in the cases where a large number of castings have to be made from the same pattern; also where the more intricate form of the pattern (as in foliage or ornamental castings) makes it difficult to draw from the sand in the ordinary process of moulding, and the irregular surface of the “parting” or separation between the moulds increases the difficulty of making a clean casting, free from “fin,” and also involving considerable time and skilful labour, which has to be repeated for every casting.

In the new process of moulding (the subject of the present paper), after the pattern has been first partially imbedded in the sand of the bottom box (as in ordinary moulding), and the parting surface accurately formed, the top box is then placed on, and is filled with plaster of Paris, or other similar material, to which the pattern itself adheres. When the plaster is set, the boxes are turned over, the sand is carefully taken out of the bottom box,

and a similar process repeated with it,—using clay-wash to prevent the two plaster surfaces from adhering. This forms a corresponding plaster mould of the lower portion of the pattern. These two plaster moulds may be called the “waste blocks,” as they are not used in producing the moulds for casting, but are subsequently destroyed.

Reversed moulds, in plaster, are now made from these waste blocks (the pattern being first removed), by placing upon the bottom box a second top box, an exact duplicate of the former top box, and filling it up with plaster (having used clay-wash as before), and doing the same with the other box. Reversed moulds are thus obtained, from which the final sand moulds for casting are made, by using them as “ramming-blocks,” upon which the sand forming the mould is rammed, by placing a third duplicate top box upon the ramming-block, and a corresponding bottom box upon the ramming-block.

The requisite “gits,” “runners,” and “risers,” are formed previously in the original sand mould, and are consequently represented in the ramming-blocks by corresponding projections or ribs upon the parting face of the one, and hollows in the other (which are then stopped up with plaster), and these are properly repeated in the final sand moulds; these last, therefore, when put together, form a complete mould for casting, just like an ordinary sand mould, but having some important advantages.

Any number of succeeding moulds can be made from the original ramming-blocks by the simple process of ramming, without any handling of the pattern or turning over the boxes; both top and bottom moulds being rammed independently, and at the same time, if desired. The parting being once accurately formed in the original mould, all the succeeding ones are necessarily correct, without any further care being required; and by carefully trimming the original, and slightly paring down the inner edges of the parting faces, if requisite, the faces of the final sand moulds have a corresponding fulness, and are readily adjusted, after the first trial, to fit so closely together, that practically no fin is left on the castings, as shewn by the specimens before the meeting, which are all of them just in the state in which they left the sand, never having been dressed or trimmed. Also the labour of forming the gits and runners afresh for each casting mould is avoided, by having them completely imprinted upon each mould in the process of ramming; and by this means all the risk is avoided of imperfect castings arising from want of uniform care or judgment in the formation of the gits, &c., by the moulder in the ordinary process. This is the more important in the case of difficult castings, where several trials may be required before the best mode of running the metal is ascertained, so as to insure sound, good castings; and by this process the exact repetition of the same plan is insured, without requiring any further attention from the moulder.

A small hollow is imprinted in the ramming-block for the top box, into which the plug for forming the git is rested whilst the box is rammed; and by this means the git is insured being formed in the right place, without any care on the part of the moulder.

When the pattern is long and very thin and intricate (as in the case of an ornamental fender front), where the general surface is also curved or winding, the difficulty of picking out the pattern from the mould is so great as to require the most skilful workman; and the length of time required for repairing the injuries of the mould, causes about eight sets of fender castings per day to be the general limit to the number that can be moulded by one man and a boy. But however difficult the pattern may be to mould in the ordinary way (if it is arranged to "draw" properly from the mould), with the new process the labour is very little greater than with an easy pattern, and the saving of time is so great that as many as 30 per day are moulded on the average by one labourer and boy.

When the pattern is slender and long it is liable to be broken in the frequent handling to which it is subjected in the ordinary process of moulding, and the expense and delay caused by breakage of patterns is of serious consequence in light ornamental work; but in the new plan this is entirely avoided, as the pattern is never handled except in the first process of moulding, to form the ramming-blocks.

When the face of the castings is required to be particularly well finished (as in the case of ornamental work) a brass or other metal pattern is made, and is dressed up and finished to the degree that may be desired in the castings, and any chasing or other additional ornament put upon it; then, after forming the ramming-block for the bottom box by a plaster cast from the pattern, in the manner before described, the pattern itself is made to form the permanent face of the ramming-block for the top box, by leaving it in the mould when the plaster is poured in; so that the plaster forms merely the parting face, and a solid back to the pattern. In this case the iron pattern is secured to the cross bars of the box by several small bolts screwed up to plates at the back of the box; so that, when the plaster is poured in, filling up the whole vacant space of the box, and setting solid around these bolts and over these nuts, the iron pattern becomes so firmly secured in the box that no ramming or moving to which it is afterwards subjected will loosen it.

In this plan the mould for the face of every casting is formed from the original metal pattern, and the pattern itself is firmly and permanently secured in the plaster bed; so that, however thin and delicate it may be, there is no risk of injury to the pattern, in moulding any number of castings;—as many as 3,000 have been cast without injury from a slender ornamental pattern;

In forming the ramming-blocks, common plaster of Paris is generally employed, as the most convenient and economical mate-



rial; and this is found to be sufficiently durable for general work. The blows of the rammer are deadened by the sand in the box, and do not fall directly upon the plaster block,—so that there is no risk of injury with ordinary care in ramming. As many as 4000 castings have been moulded from one pair of plaster blocks; but when a greater number of castings is required from one pattern, or when the size or nature of the mould renders a harder face advisable, a metal face is employed for the ramming block of the bottom box, or for the parting surface of one or both blocks. This is formed simply by running into the mould, when prepared for the plaster, a small portion of metal, consisting of zinc, hardened with about  $\frac{1}{10}$ th part of tin; sufficient metal being used to form a strong plate for the surface of the ramming-block, and the rest of the space at the back filled with plaster as usual. In practice it is more convenient generally to reverse the mode of running this metal for the face of the mould, by first ramming the box, when prepared for the plaster, full of sand, then lifting it off, and paring off the surface of the sand wherever the metal is wanted to such depth (about  $\frac{3}{8}$  of an inch) as may be desired for the metal; and when the box is replaced in its former position the metal is run in, filling up those spaces where the sand has been cut away. The sand in the upper box at the back of the metal face is then all removed, without moving the box (part at a time if requisite) and plaster poured in above to fill up the box and make a solid back as before.

The metal face is firmly secured to the plaster back by several small dovetail blocks cast upon the back of the metal, by cutting out corresponding holes in the sand mould before the metal is run in. Various modifications of this plan of construction are employed, according to circumstances, for economy or convenience; and sometimes the face of the ramming-block is partially covered by separate pieces of metal; but, in every case, the entire face of the two ramming-blocks forms a perfect counterpart of the intended casting (half being represented upon each), surrounded by parting faces which exactly fit one another, because the one has been moulded from the other.

Where the pattern is long, and a metal face is employed, a narrow division is made, subdividing the metal face into two or more lengths, to allow for the shrinking of the metal forming the face,—the effect of which is then found to be imperceptible. The plaster ramming-blocks are varnished when dried, to preserve them from damp; and, in moulding from them, the faces of the blocks are dusted with rosin, to prevent adhesion of the sand.

The new process of producing the blocks, though somewhat complicated in description, involves practically but little increase of work over the process of moulding required for the first casting produced by the ordinary method; but every subsequent casting, instead of requiring a repetition of the whole process of the first moulding, as in the ordinary method, is moulded by

simply ramming the boxes upon their respective blocks. The ordinary "odd side" boxes are used for this purpose,—all that is requisite being that every top box fits steadily and securely upon every bottom box, so that they may be interchanged in the process of forming the ramming-blocks, without disturbance of the relative position of the pattern. An improved form of the steady pins for connecting the top and bottom boxes has been adopted. Instead of four or more round pins fixed on the bottom box, and fitting into corresponding holes in lugs cast upon the top box, vertical angular studs are cast on each bottom box, and fit against corresponding projections on the edge of the top box. The only fitting required in making the boxes is to file the touching angles of the pins, so as to fit one standard top box; the projections on the top boxes being all fitted to one standard bottom box.

It has to be noticed, that in the ordinary plan of moulding, and by the "odd side" and "plate" methods, one side of a pattern is not available while the other is in use. By the new process, each pattern is equal to two, as it will be evident that both blocks may be worked from at the same time.

---

Mr. Jobson exhibited a number of specimens of castings rough from the mould, to shew the unusually small amount of fin upon them, and the good quality of the castings obtained by the new process of moulding. Also several of the plaster ramming-blocks were exhibited of the different kinds, and a pair shewn in operation, shewing the quickness of the process of moulding from them, and the perfection of the sand moulds obtained.

The Chairman thought the process was certainly very efficient in insuring expedition and accuracy, and the moulding was remarkably perfect; there must be an important economy both in the cost of moulding and in the cost of dressing the castings, which were turned out remarkably clean and free from fin.

Mr. Jobson said that in the ornamental castings the dressing formerly cost as much as £10 per ton, from the fin left in the old process of moulding; but this expense was now mostly saved, as there was practically no fin left with the new plan. The specimens exhibited showed the ordinary average work produced; and the castings were just in the state in which they left the mould, not having had any trimming or dressing. For particularly fine work a sulphur face was used for the ramming-block instead of plaster; a small thickness of sulphur being first run on to form the face of the block, like the metal facing used in those blocks from which a very large number of moulds was required to be rammed.

In answer to an inquiry, he stated that the largest size of casting at present moulded by the new process was about 3 ft. 6 in. square, and 8 ft. by 1 ft. With large castings there was seldom perhaps a case of a sufficient quantity from one pattern, or it might be advantageous to apply the plan.

PROVISIONAL PROTECTIONS GRANTED.

[*Cases in which a full Specification has been deposited.*]

2173. Pierre Etienne Proust, of Orleans, for a new system of apparatus for greasing or lubricating axles and other rotating portions of carriages and of machinery.
2174. Jean François Jules Alexandre Boulet, of La Chapelle St. Denis, near Paris, for improvements in the manufacture of steel.

*The above bear date October 11th.*

2196. Anthony Bernhard Baron Von Rathen, of Wells-street, for improvements in bakers and confectioners' ovens, and in furnaces or fire-places connected therewith; parts of which improvements are applicable also to other ovens, furnaces, and stoves.—[*Dated October 14th.*]
2223. Robert John Chippindall, of Rue de la Rochefocauld, Paris, for an improved pencil-case.—[*Dated October 17th.*]

[*Cases in which a Provisional Specification has been deposited.*]

1209. Julian Bernard, of Club Chambers, Regent-street, for improvements in the manufacture or production of boots, shoes, and other protectors for the feet, and in the materials, machinery, or apparatus employed in such manufacture.—[*Dated May 31st.*]
1788. William Burgess, of Newgate-street, for an improvement in or addition to reaping and mowing machines.—[*Dated August 16th*]
1897. Barnett Meyers, of Savage-gardens, Tower-hill, for improvements in walking-stick guns,—being a communication.—[*Dated August 30th.*]
1909. George Eden, of Norwood, for improvements in cooking utensils.—[*Dated August 31st.*]
1945. James Eden, of Lytham, Lancashire, for improvements in apparatus for drying fabrics.
1947. Joseph Westwood and Robert Baillie, both of Poplar, for a method of protecting iron ships and vessels from corrosion and animal and vegetable matters.

*The above bear date September 6th.*

1949. Edmund Calvert and William Mitchell, both of Walton-le-Dale, Lancashire, for certain improvements in looms for weaving.
1951. Paul Adolphe Garnaud, of Paris, for improvements in certain gazogene apparatus used for the production of aerated liquids.

1953. Henry Lund, of the Temple, for improvements in propelling and steering vessels, and in the steam-engine applied to these purposes.

*The above bear date September 7th.*

1955. John Thornborrow Manifold and Charles Spencer Lowndes, both of Liverpool, for improvements in windlass fittings.

1957. John Youil, of Burton-upon-Trent, for improvements in the mode or method of fermenting liquors, and in the machinery or apparatus employed therein.

1963. William Prior Sharp and William Weild, both of Manchester, for improvements in the production of raw and thrown silk, and in machinery and apparatus to be used for the purpose.

1965. James Atherton, John Kinlock, and John Swainson, jun., all of Preston, Lancashire, for improvements in machinery or apparatus for sizing or dressing yarns or threads.

1969. Henry Robert Ramsbotham and William Brown, both of Bradford, Yorkshire, for improvements in preparing to be spun, wool, cotton, hair, tow, and other fibrous materials.

*The above bear date September 8th.*

1971. John Wesley Hackworth, of Priestgate Engine Works, Darlington, for improvements in steam-engines and in gearing connected therewith.

1973. Thomas Hodson, of Manchester, for certain improvements in machinery or apparatus for doubling yarn or thread.

*The above bear date September 9th.*

1975. Peter Rothwell Jackson, of Salford, for improvements in the manufacture of wheels.

1977. Edward Palmer, of Southampton, for improvements in propelling vessels.

1979. James Worrall, jun., of Salford, for improvements in the method of treating and printing such fustian goods or fabrics as are called "cords" and "thicksets," or "velveteens."

1981. John Chillcott Purnelle, of Tachbrook-street, Pimlico, for improvements in obtaining and applying motive power.

*The above bear date September 11th.*

1983. Edward Gillman, of Twickenham, for obtaining filaments from certain vegetable substances, and applying the same to various manufacturing purposes.

1985. Charles Wentworth Forbes, of Bartley, Hants, for an improved rest for fire-arms.

1987. Joseph Williams, of Liverpool, for improvements in propellers.

*The above bear date September 12th.*

1989. William Muir Campbell, of Glasgow, for improvements in furnaces or fire-places, and in the prevention of smoke.

1991. John Brookes, of Birmingham, for a new or improved waistcoat.

1993. Joseph Betteley, of Liverpool, for improvements in giving elasticity to ships' standing rigging.

*The above bear date September 13th.*

1995. John Hossack, of Manchester, for improvements in machinery or apparatus for measuring the flow of water or other liquids and fluids.

1996. Charles Frederick Stansbury, of Cornhill, London, for improved machinery for making screws,—being a communication.

1998. Charles Frederick Stansbury, of Cornhill, London, for improvements in punches and dies,—being a communication.

1999. Alfred Wilson and George Wilson, of Nottingham, for improvements in knitting machinery.

2000. Robert Adams, of King William-street, City, for improvements in machinery for boring and rifling the barrels of fire-arms.

2001. William Bramwell Hayes, of Manchester, for certain improvements in looms for weaving.

2002. Julian Bernard, of Club Chambers, Regent-street, for improvements in the manufacture of boots and shoes or other coverings for the feet.

2003. Thomas Purdon, of Hull, for improvements in safety-lamps.

2004. Robert Rawlinson, of Westminster, for improvements in valves or adjustable thoroughfares.

2005. George Frederick Evans, of Hanover Lodge, Kew Bridge, and Frederick John Evans, of the Gas Works, Horseferry-road, for improved apparatus to be used in the distillation of coal and other bituminous or resinous substances.

*The above bear date September 14th.*

2006. Felix Fontenau, of Paris, for an improved mode of preventing mud from touching or adhering to carriages.

2007. John William Perkins, of Poplar-terrace, High-street, Poplar, for improvements in purifying gas,—the residuum arising from which forms a new artificial manure.

2008. Andrew Barclay, of Kilmarnock, for improvements in refracting and reflecting telescopes.

*The above bear date September 15th.*

2009. Samuel Collins, of Birmingham, for a new or improved castor for furniture.

2010. Joseph Harrison, John Oddie, John Eaves, and Henry Graham, all of Blackburn, for improvements applicable to machines for warping, sizing, or otherwise preparing yarns or threads for weaving.

*The above bear date September 16th.*

2011. William Simpson, of Birmingham, for an improvement or improvements in beams or girders for bridges and other structures.
2012. John Ashworth, of Bristol, for certain improvements in sizing and stiffening textile materials or fabrics.
2013. Nathan Thompson, jun., of New York, for improvements in life-preserving seats.
2014. George Thorne and Samuel Lemon, both of Fore-street, for improvements in fascia-boards, sign-boards, or name-boards.
2015. William Edward Newton, of the Office for Patents, 66, Chancery-lane, for improvements in tuning-keys for piano-fortes and other stringed musical instruments,—being a communication.
2016. Oscar Delloye Smal, of Huy, for a new system of oven for metals.
2017. Samuel Crabtree, of Bradford, Yorkshire, for improvements in machinery for combing wool, hair, and other fibrous substances.
2018. Thomas Lewis and Abraham Bartle, of Birmingham, for improvements in apparatus for purifying water.

*The above bear date September 18th.*

2019. William Henry Dawes, of Handsworth, Staffordshire, for an improvement in the manufacture of iron.
2020. George Piercy and George Collins, of Judd-place West, New-road, for improved apparatus for heating and supplying heated liquids to baths; useful also for supplying heated liquids for other purposes.
2021. John Cunningham, of Beith, Ayrshire, N.B., for improvements in the preparation or production of printing surfaces.
2022. Joseph Porter, of the Salford Screw Bolt Works, near Manchester, for improvements in machinery for cutting, punching, forging, and forming nuts, bolts, screws, and various other articles in metal.
2023. James Kershaw, of Bury, for improvements in looms for weaving.

*The above bear date September 19th.*

2025. William Gee, of Birmingham, for an improvement or improvements in the manufacture of braces used for boring, driving screws, and other such like purposes.
2026. Martin Billing and Walter George Whitehead, both of Birmingham, for a new or improved waterproof paper.
2027. James Robinson, of Huddersfield, for improvements in apparatus for generating steam and gas and consuming smoke.
2028. William Garnett, of Low Moor, near Clitheroe, for improvements in and applicable to machines for warping and sizing yarns or warps.
2029. Victor Athanase Pierret, of Paris, for improvements in watches and clocks.

2030. John Henry Johnson, of Lincoln's-inn-fields, for improvements in ovens or furnaces for melting or manufacturing glass,—being a communication.
2031. Jean Baptiste Edouard Savary and Jules Felix Hazard, both of Paris, for improvements in pumps.
2032. Auguste Edouard Loradoux Bellford, of Castle-street, for certain improvements in machines for drilling stone,—being a communication.
2033. Auguste Edouard Loradoux Bellford, of Castle-street, for certain improvements in machinery for washing paper stock,—being a communication.
2034. Auguste Edouard Loradoux Bellford, of Castle-street, for a new and improved governor for engines and machinery,—being a communication.
2035. Auguste Edouard Loradoux Bellford, of Castle-street, for certain improvements in sewing machines,—being a communication.
2036. Auguste Edouard Loradoux Bellford, of Castle-street, for a new mathematical instrument, to be termed the "horometer," for the purpose of solving problems in plane and spherical trigonometry,—one feature of which invention is or may be applicable in the construction of other mathematical instruments,—being a communication.

*The above bear date September 20th.*

2037. Henry Hudson, of the South Shields Flint Glass Works, for improvements in the manufacture of vessels for measuring fluids.
2038. William Prior Sharp and William Weild, both of Manchester, for improvements in machinery for winding, cleaning, doubling, spinning, and throwing of silk.
2039. Jean Antoine Passet, of Paris, for improved machinery or apparatus for pressing or calendering fabrics.
2040. Matthew Moneymont, of Lamb's Conduit-street, for improvements in hat, bonnet, and other boxes.
2041. William Hodson, of Kingston-square, Hull, for improvements in apparatus for the manufacture of bricks, tiles, and other articles from plastic materials.

*The above bear date September 21st.*

2042. William Crofts, of Derby-terrace, Nottingham-park, for improvements in the manufacture of fringes and other plain and ornamental fabrics.
2043. James Egleson Anderson Gwynne, of Essex Wharf, Strand, for improvements in machinery for lifting, forcing, and exhausting.
2044. John Henry Johnson, of Lincoln's-inn-fields, for improvement in machinery or apparatus for manufacturing cards employed in the preparation of fibrous materials,—being a communication.

2045. Henry Holland, of Birmingham, for improvements in the manufacture of umbrellas and parasols.
2046. Thomas Lawrence, of Birmingham, for improvements in machinery or apparatus to be employed for the purpose of shaping and finishing certain parts of bayonets.
2047. Peter Spence, of Pendleton, for improvements in obtaining sulphur from iron pyrites and other substances containing sulphur.
2048. George Collier, of Halifax, and Samuel Thornton, of Rochdale, for improvements in looms for weaving.
2049. William James Brown, of Bristol, for improvements in a composition or combination of materials to be used for sizing yarns and other articles.

*The above bear date September 22nd.*

2050. Thomas Garnett, of Liverpool, for improvements in steam-engine and other governors.
2051. Pietro Feloj, of Fleet-street, for improvements in the manufacture or construction of a knife and fork.
2052. Thomas Banks, of Derby, and Henry Banks, of Wednesbury, for improvements in apparatus for retarding and stopping railway trains.
2053. Samuel Elliott Hoskins, of Guernsey, for an improvement in the manufacture of paper.
2054. John Henry Johnson, of Lincoln's-inn-fields, for improvements in the generation of steam,—being a communication.
2055. Robert Pinkney, of Long-acre, for improvements in stoppers, corks, or valvular apparatus for bottles or receptacles for liquids, and in the machinery or apparatus employed for making the same.
2056. George McNaught, of Glasgow, for improvements in saddletrees.
2057. Georges Danré, of Marseilles, for certain improvements in gas-burners.
2058. Henry Alexandre Genetreau, of Paris, for an improved system of carriage-shafts, poles, or beams.

*The above bear date September 23rd.*

2059. William Marshall, of Wachinghem, Pas-de-Calais, France, for an improvement or improvements in metallic wheels for railway and other purposes.
2060. Robert Mc Connel, of Glasgow, for improvements in locks.
2061. Philip James Chabot, of Spitalfields, for improvements in supplying air to furnaces.
2062. Henry Heather Bigg, of Leicester-square, for improved apparatus for curing deformities of the human frame.
2063. Henri Catherine Camille de Ruolz and Anselme Louis Marie de Fontenay, both of Paris, for improvements in the treatment of certain metals for producing an improved metallic alloy.



2064. William Palmer Surgey, of Hackney, for improvements in cigars, cigarettes, and cheroots.

*The above bear date September 25th.*

2065. Joshua Bachelor Halsey, of Norfolk-street, Strand, for an improved machine or apparatus for crushing and pulverizing ores, and for separating the gold therefrom by amalgamation.

2066. Louis Cornides, of Trafalgar-square, for a new mode of manufacturing a transparent medium, plain, printed, and colored, of gelatine, in combination with other substances.

2067. Joseph Boulton, of Coppice-row, Clerkenwell, for improvements in dry gas-meters.

2068. George Spencer, of Alpha-road, New-cross, Deptford, for improvements in the external coverings of roofs and walls of buildings and sheds, and in the windows of such buildings and sheds.

2069. William Flowerdew Sadler, of Tooley-street, for a machine or apparatus for using up all the smoke of furnaces and other fire-places.

2070. Thomas Clayton, of Oldham, and Robert Harrop, of Low-side, near Oldham, for improvements in ornamenting wood, and in the machinery or apparatus connected therewith.

2071. The Honorable James Sinclair, commonly called Lord Berriedale, of Hill-street, for improvements in treating, cleansing, and ornamenting paper and other surfaces.

*The above bear date September 26th.*

2073. John Simon Holland, of Woolwich, for improvements in large and small fire-arms, and in the preparation of their charges.

2074. William Kimmins Mc Minn, of Robert-street North, Liverpool, for letting go and heaving up ships' anchors,—which he calls a double-acting anchor purchase.

2075. Charles Barraclough, of Halifax, for improvements in machinery or apparatus for the manufacture of clog soles and patten soles by power.

2076. Jonathan Edge, of Bolton-le-Moors, for improvements in pistons.

2077. John Chambers, of Manchester, for improvements in washing fabrics, and in machinery employed therein.

2078. Robert Hoyle, of Whitehead-bridge, Bury, for improvements in preventing incrustation in steam-boilers.

2079. Robert Renfrew, of Glasgow, for improvements in bobbins.

*The above bear date September 27th.*

2080. Frederick Clark, of King-street, Westminster, for an improved spindle and bush for door-knobs, and other similar uses.

2081. Aretas Young Crosse, of Blackheath, for improvements in the manufacture of buttons.

2082. John Rogerson and James Brimelow, both of Bolton, for improvements in certain parts of steam-engines.

2083. James Simpson, of Roehdale, for an improvement in the manufacture of "printers' blankets."  
2084. Alfred Vincent Newton, of the Office for Patents, 66, Chancery-lane, for an improvement in the rigging of sailing vessels,—being a communication.  
2085. William Hutchinson and William Barlow, both of Salford, for improvements in steam-boilers.  
2086. William Beckett Johnson, of Manchester, for improvements in lamps and other apparatus used for illumination.  
2087. George Cruz, of Manchester, for improvements in the production of bonnets, children's hats, and similar coverings for the head.  
2088. John Woodward, of Barnet, for certain apparatus for stopping shot and other holes in ships and vessels.  
2089. Charles William Lancaster, of New Bond-street, for improvements in fire-arms, and in cartridges to be used therewith.  
2090. Moses Poole, of Avenue-road, Regent's-park, for improvements in cylinder paper machines,—being a communication.  
2091. Louis Beer, of Elbeuf (Seine Inférieure), France, for certain improvements in machinery for shearing piled, terry, or raised fabrics.

*The above bear date September 28th.*

2092. Thomas Foxall Griffiths, of Birmingham, for an improvement or improvements in lamps.  
2093. Thomas Mohan, of Aclint, Louth, for an improved churn.  
2094. Walter Sneath, of Derby-road, Nottingham, for an improvement in sewing machines.  
2095. John Nelson Gamewell, of Camden Kershaw District, South Carolina, U. S., for improvements in instruments for relieving the wires of the electric telegraph of atmospheric electricity.  
2096. John Henry Johnson, of Lincoln's-inn-fields, for improvements in machinery for removing the points from the hairs of rabbit and other skins employed in the manufacture of hats and similar articles,—being a communication.

*The above bear date September 29th.*

2098. James Bradbury and John Bradbury, both of Denton, Lancashire, for improvements in machinery or apparatus for manufacturing or producing piled goods or fabrics.  
2100. Gémis Fihon, of Paris, for improvements in glass chimneys for gas-burners or lamps.  
2102. Arthur Boyle, of Birmingham, for improvements in making umbrella and parasol stretchers.  
2104. George Fergusson Wilson and George Payne, both of Belmont, Vauxhall, for improvements in the manufacture and application of rosin oil.

*The above bear date September 30th.*

2106. Thomas Gray, of Saint Clement's-lane, Strand, for a new and improved method of preparing and bleaching raw and fabricated fibrous substances now used in the manufacture of paper, or which are applicable to be used in such manufacture.
2108. William Woods Cook, of Rumforth, near Bolton, for an improved method of weaving or manufacturing woven fabrics, suitable for petticoating or similar purposes, where thick and thin parts of the same fabric are required.
2110. William Partington, of Bonhill, Dumbarton, N. B., for improvements in bleaching.
2112. Charles Bowles Hare, of Bristol, for an improved mode of manufacturing printing blocks.
2114. John Penn, of Greenwich, for an improvement in the bearings and bushes for the shafts of screw and submerged propellers.
2116. John Stephens, of the Temple, for improvements in apparatus for supplying purified air to rooms or buildings.

*The above bear date October 2nd.*

2120. John Jeyes, of Northampton, for an improvement in the manufacture of paper, threads, and yarns.
2122. William Edward Newton, of the Office for Patents, 66, Chancery-lane, for improvements in the construction of locks, —being a communication.
2124. Christopher Nickels, of the Albany-road, Surrey, and James Hobson, of Leicester, for improvements in apparatus used when weaving piled fabrics by the aid of wires.
2126. Thomas Cooper, of the Isle of Wight, for an improvement in the manufacture and in the mode of joining earthen pipes.

*The above bear date October 3rd.*

---

## **New Patents.**

*Sealed under Patent Law Amendment Act, 1853.*

---

1854.

- |                                   |                          |
|-----------------------------------|--------------------------|
| 714. Alfred Hodgkinson.           | 796. Emile Dupont.       |
| 716. Henry Francis.               | 800. Julian Bernard.     |
| 733. P. J. Passavant and J. Cure. | 801. James Worrall, jun. |
| 758. James Forsyth.               | 807. F. R. A. Glover.    |
| 768. Joseph Bentley.              | 820. William Naylor.     |
| 773. H. Y. D. Scott.              | 821. William Naylor.     |
| 789. James Smith.                 | 834. Henry Gilbee.       |
| 794. A. E. L. Bellford.           | 843. Zachariah Round.    |

- |                                   |                                       |
|-----------------------------------|---------------------------------------|
| 847. C. A. Noedl.                 | 1091. G. Manwaring and W. A. Summers. |
| 848. John Mitchell.               | 1103. J. Worthington & F. Allman.     |
| 850. T. S. Whitworth.             | 1125. A. E. L. Bellford.              |
| 854. B. Fothergill and W. Weild.  | 1145. John Biggs.                     |
| 857. Edward Briggs.               | 1182. William Stenson, jun.           |
| 864. E. W. Hansen.                | 1210. L. J. Molinos and C. Pronnier.  |
| 866. A. H. Cox.                   | 1248. Edward Manière.                 |
| 867. J. Greenwood and R. Smith.   | 1255. John Nicholson.                 |
| 869. James Griffiths.             | 1260. W. E. Newton.                   |
| 872. Joseph Croisy.               | 1273. R. A. Brooman.                  |
| 873. Thomas Lawes.                | 1282. A. L. Dawson.                   |
| 875. Alexander Chaplin.           | 1323. John Rawe.                      |
| 879. G. L. F. Tired.              | 1339. Henry Worrall.                  |
| 881. Thomas Hawkins.              | 1351. G. R. Chittenden.               |
| 883. W. H. Bentley.               | 1412. Andrew Smith.                   |
| 884. Benjamin Fullwood.           | 1416. William Morgan.                 |
| 890. Julian Bernard.              | 1427. W. J. Bissek.                   |
| 891. Julian Bernard.              | 1490. N. M. Caralli.                  |
| 892. John Rowley.                 | 1514. Edwin Wolverson.                |
| 893. Charles Watt.                | 1542. R. Bodmer.                      |
| 895. John Frearton.               | 1545. A. S. Stocker.                  |
| 897. J. F. F. Challeton.          | 1598. Thomas Chambers, jun.           |
| 898. J. D. Pfeiffer.              | 1602. A. V. Newton.                   |
| 906. Thomas Vickers.              | 1624. G. F. Wilson and G. Payne.      |
| 916. F. B. Anderson.              | 1633. T. Bell and H. Scholefield.     |
| 920. William and Joseph Harcourt. | 1635. J. C. Hurd.                     |
| 924. A. B. Barlow.                | 1638. J. A. Cutting.                  |
| 925. P. J. F. Mouchel.            | 1642. A. E. L. Bellford.              |
| 928. Joseph Gill.                 | 1645. Thomas Huckvale.                |
| 932. C. E. Blank.                 | 1650. A. E. L. Bellford.              |
| 933. David Buddo.                 | 1667. A. H. Petit.                    |
| 946. William Collier.             | 1669. James Gilbertson.               |
| 949. J. Lawson and S. Dear.       | 1672. E. Burke and A. S. Stocker.     |
| 952. E. Crosland and T. Boardman. | 1681. Henry Walduck.                  |
| 956. J. H. Johnson.               | 1693. John Mc Gaffin.                 |
| 961. Frederick Woodbridge.        | 1694. W. E. Newton.                   |
| 970. J. Porter and R. Howson.     | 1699. Samuel Lees.                    |
| 971. E. Briggs and W. Souter.     | 1706. Charles Tetley.                 |
| 972. W. A. Waddington.            | 1711. S. L. Taylor.                   |
| 985. Carlo Minasi.                | 1725. G. A. Cox.                      |
| 986. R. J. Mary'on.               | 1727. J. H. B. Thwaites.              |
| 988. Désiré Plisson.              | 1732. Thomas Waterhouse.              |
| 1002. John Manley.                | 1739. Alexander Ogg.                  |
| 1011. V. Wanostrocht.             | 1774. Joseph Beardmore, jun.          |
| 1021. Charles Cammell.            | 1780. John Coupland.                  |
| 1029. G. B. Goodman.              | 1787. William Kennard.                |
| 1044. J. Anthony and W. T. Chafe. | 1842. W. H. Meriwether.               |
| 1049. Henry Tylor.                | 1848. Charles Blunt.                  |
| 1055. John Platt.                 |                                       |
| 1067. A. E. L. Bellford.          |                                       |

\* \* \* For the full titles of these Patents, the reader is referred to the corresponding numbers in the List of Grants of Provisional Protections.

CELESTIAL PHENOMENA FOR NOVEMBER, 1854.

D. H. M.		D. H. M.	
1	Clock after the ☉ 16m. 16s.	16	Ceres, R. A., 21h. 5m. dec. 26.
—	☽ rises 3h. 44m. A.	—	51. S.
—	☽ passes mer. 9h. 32m. A.	—	Jupiter, R. A., 19h. 42m. dec.
—	☽ sets 2h. 14m. M.	—	21. 47. S.
4	Partial Eclipse of the ☽	—	Saturn, R. A., 5h. 40m. dec. 20.
6 52	First Contact.	—	40. N.
9 12	Mid. Eclipse.	—	Uranus, R. A., 2h. 47m. dec. 15.
11 31	Last Contact.	—	47. N.
9 1	Ecliptic oppo. or ☉ full moon.	—	Mercury passes mer. 0h. 11m.
—	Occul. ♂ Arietis, im. 9h. 59m.	—	Venus passes mer. 23h. 20m.
—	em. 10h. 58m.	—	Mars passes mer. 2h. 5m.
4 41	♃'s first sat. will em.	—	Jupiter passes mer. 4h. 0m.
13 48	♃ in conj. with the ☽ diff. of dec.	—	Saturn passes mer. 13h. 7m.
—	0. 19. N.	—	Uranus passes mer. 11h. 5m.
5	Clock after the ☉ 16m. 16s.	17 3 59	♃ in the ascending node.
—	☽ rises 4h. 46m. A.	18 6 38	Vesta in conj. with the ☉
—	☽ passes mer. Morn.	13 26	Vesta in conj. with ♃
—	☽ sets 7h. 30m. M.	19 36	♃ in inf. conj. with the ☉
6	Occul. ♀ Tauri, im. 5h. 24m.	19 11 59	♀ in conj. with the ☽ diff. of dec.
—	em. 5h. 54m.	—	0. 45. N.
19 12	Juno in conj. with ♀ diff. of dec.	18 30	♃ in conj. with the ☽ diff. of
—	5. 39. N.	—	dec. 1. 14. N.
22 15	♃ in oppo. to the ☉	20	☉ eclipsed, invis. at Greenwich
23 16	♃ in conj. with the ☽ diff. of dec.	—	Clock after the ☉ 14m. 13s.
—	8. 53. S.	—	☽ rises 7h. 30m. M.
7	Occul. 12♁ Tauri, im. 16h. 5m.	—	☽ passes mer. 11h. 49m. M.
—	em. 17h. 4m.	—	☽ sets 3h. 58m. A.
8	Ceres in Aphelion.	20 10 2	Ecliptic conj. or ☉ new moon.
10	Clock after the ☉ 15m. 56s.	21 4 17	♃ in conj. with ♀ diff. of dec.
—	☽ rises 8h. 10m. A.	—	0. 38. N.
—	☽ passes mer. 4h. 3m. M.	17 42	♃ in Perihelion.
—	☽ sets 0h. 49m. A.	22 6 5	♂ in conj. with the ☽ diff. of dec.
—	Occul. ♀ Cancri, im. 16h. 1m.	—	2. 16. N.
—	em. 17h. 14m.	11	☽ in Perigee.
18	☽ in Apogee.	23 18 59	♃ in conj. with the ☽ diff. of dec.
11 6 36	♃'s first sat. will em.	—	4. 14. N.
12 10 9	☽ in ☐ or last quarter.	25	Occul. 35 Capricorni, im. 6h. 45m.
15	Clock after the ☉ 15m. 15s.	—	em. 7h. 44m.
—	☽ rises 0h. 52m. M.	—	Clock after the ☉ 12m. 56s.
—	☽ passes mer. 7h. 53m. M.	—	☽ rises 0h. 55m. A.
—	☽ sets 2h. 36m. A.	—	☽ passes mer. 4h. 58m. A.
16	Mercury, R. A., 15h. 52m. dec.	—	☽ sets 9h. 10m.
—	20. 38. S.	4 15	♃'s second sat. will em.
—	Venus, R. A., 15h. 0m. dec. 16.	27 2 40	☽ in ☐ or first quarter
—	9. S.	4 56	♃'s first sat. will em.
—	Mars, R. A., 17h. 46m. dec. 24.	12 48	Vesta in conj. with ♀ diff. of
—	29. S.	—	dec. 3. 2. N.
—	Vesta, R. A., 15h. 33m. dec. 15.	28 2 22	♃ stationary.
—	28. S.	7 22	♃'s fourth sat. will em.
—	Juno, R. A., 14h. 27m. dec. 7.	30	Clock after the ☉ 11m. 9s.
—	29. S.	—	☽ rises 2h. 20m. A.
—	Pallas, R. A., 19h. 34m. dec. 0.	—	☽ passes mer. 9h. 0m. A.
—	47. N.	—	☽ sets 2h. 40m. M.

J. LEWTHWAITE, Rotherhithe.

THE  
LONDON JOURNAL,  
AND  
REPERTORY  
OF  
Arts, Sciences, and Manufactures.

---

CONJOINED SERIES.

---

No. CCLXXVI.

---

RECENT PATENTS.

To LEWIS JENNINGS, of *Fludyer-street, in the City of Westminster, mechanical engineer, for an improved mode of producing plain and ornamental sewing, and in machinery applicable thereto.*—[Sealed 30th November, 1853.]

THIS invention relates to the formation of a novel kind of tie stitch, or a stitch which will have a sufficiently independent character to ensure the strength of any seam which it may be employed to form, although the seam were purposely injured by severing the thread in several places. And this invention is also intended to effect an economy in the manufacture of sewing machines by simplifying their construction.

In Plate XI., fig. 1, shews in longitudinal sectional elevation the improved sewing machine; fig. 2, is an end elevation, partly in section, to shew the arrangement for feeding the cloth; and fig. 3, is a sectional plan view taken in the line 1, 2, of fig. 1. *a, a*, is a cast-iron hollow framing for supporting the various parts of the mechanism. *b*, is a short cam-shaft, which receives rotary motion from any first mover. Upon this shaft is a cam-wheel *c*, which is provided with a cam-groove *d*, for the reception of the bowle of a rocking-lever *e*, and a face-cam *f*, against which the bowle of a rocking-lever *g*, works, for the purpose to be presently explained. The outer end of the lever *e*, which has its fulcrum at *e\**, is connected loosely, by means of an adjustable collar *h\**, to a round bar *h*, which carries at its

lower end the needle *i*. This needle bar slides in guides made for it in the frame *a*, and by that means is kept in a vertical position, while, by being round, it admits of the ready adjustment of the needle. Immediately below the needle the framing *a*, is cut away, and a guide-plate *i*\*, is inserted, to permit of the descent of the needle below the bed of the framing when it pierces the cloth. Contiguous to this guide-plate *i*\*, is the feed-wheel *k*, which projects through the opening made in the bed of the framing, and, by reason of an intermittent axial motion which it receives, carries forward the fabric, which is kept in contact with its roughened periphery by means of the ordinary spring-presser *k*\*. This wheel *k*, is mounted loosely on an axle *l*, bolted to the framing; and the boss of the wheel serves as a fulcrum for a lever *m*, which is capable of moving independently of the wheel. Connected to this lever is a rocking segment-piece *n*, which bears against the inner periphery of the feed-wheel. Beneath the end of the lever *m*, and kept in contact therewith, by the downward pressure of a spring *m*\*, is an arm of a compound rocking-lever *o*, the other arm of which bears against the cam-shaft *b*, at the part of its periphery which is recessed, as shewn at fig. 1, and therefore acts as a cam to rock the lever *o*. As long as the larger radius of this cam is presented to the lever, the feed-wheel will be stationary; but as soon as the smaller radius is presented (which will take place when the needle is raised out of the fabric), the spring *m*\*, will come into action and depress the lever *m*,—which movement of the lever *m*, will cause the segment *n*, to grip the feed-wheel, and move it round a portion of a revolution. The amount of motion permitted to the lever *m*, will determine the amount of axial motion imparted to the feed-wheel, and consequently the length of stitch put into the work. A screw-stop *n*\*, is therefore provided,—by turning which to the right or left, the length of stitch required may be readily obtained. Jointed loosely to the opposite end of the lever *g*, to that which carries the friction-bowle, is a slotted guide-piece *p*, for carrying the finger *q*, and regulating its movements. This finger is peculiarly shaped, as shewn best in the plan view, fig. 3, and is intended to catch up the loops as they are formed by the depression of the needle into the fabric under operation, and to interlace the loops, one within the other, in such a manner as to form a firm and secure stitch. Into the slit of the guide-piece a fixed (adjustable) pin projects; and, as the lever *g*, is vibrated, the finger is caused to oscillate on its fulcrum, and thereby bring the loops in succession under the descending needle, to effect the proper interlocking of the

stitches. The thread for forming the stitches is carried by a bobbin *r*, at the top of the machine. In passing from this bobbin it enters the eye of an adjustable guide *s*. The thread next passes through a guide carried by the needle-bar, and is brought down in front of the machine to the eye of the needle. This guide *s*, is made adjustable, in order that the eye through which the thread passes may be raised or lowered, according to the quality of work to be sewn. Attached to the front part of this framing is a spring-presser *t*, behind which the thread passes on its way to the needle. From this presser projects inwards a pin, which bears against the carrier *h\**, of the needle-bar; and, by that carrier being chamfered at its lower part (as shewn by dots in fig. 1,) the presser *t*, as the needle-bar rises, is permitted to close upon the thread, and hold it fast; but immediately before the needle enters the fabric, the presser will be thrust outward and the thread will be released. The tension of the thread is preserved by means of a weighted lever *u*, pressing upon the under side of the bobbin.

The machine is shewn as arranged for producing the novel kind of stitch exhibited by the diagram fig. 4, wherein each loop is similarly interlocked, and thus a very secure seam is ensured; but this machine is also capable of producing the stitch shewn by the diagram fig. 5, as well as the common crochet stitch, by merely substituting for the cam-wheel *c*, another cam-wheel, which will effect the change in the relative movements of the needle and loop-finger suitable for producing the required stitches. The operations of this machine to form the stitch shewn at fig. 4, are as follows:—Supposing the fabric to be sewn to lie between the feed-roller *k*, and the presser *k\**, and the thread to have been passed through the eye of the needle *i*, rotary motion is imparted to the shaft *b*; and by means of the cam *d*, the lever *e*, is rocked into the position shewn at fig. 1. The needle will now have entered the fabric, and the next movement is to draw the thread which the needle has brought down into a loop. This is effected by the advance of the finger *g*, which, by taking up the thread upon its point, prevents the needle on its ascent from drawing back the thread. The advance of the finger *g*, is effected by means of the face-cam *f*, rocking the lever *g*, on its fulcrum. In the diagram fig. 6, No. 1, shews the loop as formed on the finger and the needle depressed to form a second loop: that is, in the position it will take when the part 1, of the cam-groove *d*, is acting upon the bowl of the lever *e*. By the rotation of the cam-wheel *c*, in the direction of the arrow, the part 2, of the cam-groove will come under the bowl of the lever *e*, at the moment



that the part 2, of the face-cam *f*, (see the diagram, fig. 7, which shews this face-cam laid out flat), acts upon the bowle of the lever *g*, and thus the needle will be raised (to slack the thread), and the finger advanced simultaneously to the position of No. 2, which represents the finger as having thrust the first formed loop through the second loop, which is now being made by the ascent of the needle. When the part 3, of the cam-groove has come round, the needle will have risen free of the work as at No. 3, and formed a loop on the shoulder of the finger; and simultaneously with that movement, the cam-shaft *b*, by presenting a recess to the end of the lever *o*, will have permitted the partial rotation of the feed-wheel *k*, and consequently of the advance of the fabric; the thread having been at the same time slackened off to facilitate this operation, by the part 3, of the cam-face *f*, presenting itself to the lever *g*, and permitting the finger to recede a short distance. The continued rotation of the cam *c*, will bring the part 4, of the cam-groove into action, and the needle will descend as at No. 4, to make another stitch. The finger being still advanced (and held under the needle by means of the fixed pin projecting through the outer end of the slot in the guide-piece *p*,) the needle will now pass through the loop on the shoulder of the finger; and, as the needle continues to descend, the part 1\*, of the cam-face *f*, will be brought under the bowle of the lever *g*, and thereby the finger will be drawn back. The loop now caught by the needle will be drawn off the point of the finger, and the loop formed on the shoulder of the finger will be drawn forwards on to the point, as shewn at No. 5. The continued depression of the needle, caused by the action of the part 1\*, of the cam-groove, will carry the thread through the loop on its shaft; and, when the thread is slackened by the partial rising of the needle, as before explained, the finger, advanced by the part 2\*, of the cam-face *f*, coming into action, will carry the loop on its point through the loop formed by the slackened thread; and by a repetition of these movements the row of stitches, shewn at fig. 4, will be produced.

In order to produce the stitch shewn at fig. 5, a cam, constructed as shewn at fig. 8, is substituted for the cam *c*. The face *f*, of this cam is shewn, as laid out flat, at fig. 9. The diagrams, fig. 10, shew the different movements of the needle and finger to form the stitch. As these are very similar to those described with respect to fig. 6, and as the parts of the cam for effecting these several movements are numbered to correspond with the diagrams illustrating the movements, it will be unnecessary to refer particularly to any other of the

movements than those marked Nos. 5, and 6, which are peculiar to this stitch. Referring to the description of the movement No. 5, of fig. 6, instead of the finger waiting for the descent of the needle to pass the thread through the cast-off loop, the finger advances, as shewn at No. 5, fig. 10, and tightens the loop which the needle has received on its shaft. This is effected by the part 5, of the cam-face *f*, fig. 9, coming into action. The finger then recedes by reason of the depression 6, in the cam-face, and drops the loop which it held, which loop is drawn up by the descent of the needle, as shewn at No. 6. Part 7, of the cam-face now comes into operation, and drives the finger forward, to catch up another loop, as shewn at No. 7; and the movements described with reference to fig. 6, and numbered 1, 2, 3, 4, are then repeated.

The patentee claims, First,—the mode of forming tie-stitches, as described with reference to the diagrams fig. 6, and the modification thereof shewn in the diagrams, fig. 9. And particularly, with reference to the modification of stitch shewn at fig. 9, causing the finger to advance to the position shewn at No. 5, whereby the cast-off loop (now lying on the needle-shaft) will be pulled up and tightened, without depending upon the movement of the needle to effect that object. Secondly,—the general arrangement of sewing machinery, as above described, for producing plain and ornamental sewing. And, particularly, the round needle bar, with the needle set eccentrically to its axis, for the purpose of facilitating the adjustment of the needle. Also the grip motion, for actuating the feed-roller, as explained. And likewise the arrangement of spring-presser, for holding the thread at tension, and preventing it from becoming entangled while the needle is descending.

---

*To NEHEMIAH HUNT, of the State of Massachusetts, United States of America, for improvements in machinery for sewing cloth or other material,—being a communication.*  
—[Sealed 19th January, 1854.]

THE improved sewing-machine, which forms the subject of the present invention, is shewn in several views in Plate XI. Fig. 1, is a longitudinal section of the machine; fig. 2, is an under side view of it; and fig. 3, is a transverse section of the table, shewing the feeding-wheel and the apparatus for imparting movement thereto. *a*, denotes the frame or table of the machine; *b*, is the goose-neck or arm thereof; *c*, is the main driving-shaft, having a fly-wheel *d*, placed upon it;

*e*, is the needle-carrier; *f*, the needle; *g*, the shuttle; *h*, the shuttle-driver; and *i*, the shuttle-race. This machine performs the operations of sewing by the conjoint action of a needle and shuttle, in a manner well known and understood; the shuttle having imparted to it an intermittent rectilinear movement. As the mechanism by which the needle is made to move in vertical directions is not essentially different from such as is generally adopted in similar machines, it needs no particular description. The cloth, during the operation, is fed along by the intermittent rotary movement of a feeding-wheel *l*, which is placed and made to revolve on a stationary shaft *m*, which serves as a support to one end of the driving-shaft. This feeding-wheel is formed with a serrated or toothed periphery, and with a circular groove or channel *a\**, made in its inner side and concentric with its periphery. Into this groove a T-shaped lever or brake *n*, is inserted. The part *b\**, of the lever is a portion of an annulus, whose transverse section corresponds with that of the groove,—it being made to fit the groove, so that it can slide freely in it, while the lever stands perpendicularly to the plane of the side of the feeding-wheel. The fitting of the brake part *b\**, of the lever, with respect to the groove, should be such, that, when the lever is turned a little, or moved out of a position at right angles to the side of the wheel, the brake shall be made to bind or press against the two opposite concentric surfaces of the groove of the wheel. A screw or pin *c\**, extending from an arm *d\**, of a lever *o*, is made to enter a hole formed in the brake-lever. One end of a spring *p*, is attached to the outer side of the brake-lever at or near the brake,—such spring being made to project beyond the inner end of the brake-lever, and to rest against one end of a slide *q*, inserted and made to slide freely in the lever *o*, and to be moved outwards by a cam *r*, fixed on the driving-shaft. There is another cam *s*, fixed on the driving-shaft,—the office of such cam being to depress the lever *o*; such lever turning on a fulcrum at *t*, and being raised by the contractile power of a spring *u*. The extent of upward movement of the lever *o*, is regulated by a stop-screw *v*, against which an arm *e\**, from the lever abuts, when the lever rises up to its highest position. Under this state of things, during the revolution of the driving-shaft, the brake-lever will be moved by its cam, so as to bind or bear against the two opposite concentric sides of the groove *a\**; and, as soon as this has been accomplished, the lever *o*, will be moved downwards by its cam, and thereby move the brake-lever, and cause it to rotate the feed-wheel the distance

required for the production of a stitch of the sewing. In the improved feeding-apparatus the friction-brake is made to act against two surfaces at one and the same time, and in such manner or with such power of hold upon them as completely to prevent it from slipping along on them while the feed-wheel is being moved. When a friction-brake or knuckle is caused to operate against a single surface or flange upon the feed-wheel, it is very apt to slip; and thus the stitches of the line of sewing would be liable to be made of variable lengths. The grip or hold of the brake on the feeding-wheel is not produced by the movement of the lever which causes the brake to turn the feeding-wheel, but by a separate mechanism, viz., a cam-slide and a spring, which, by their co-operation and action, produce the grip or hold of the brake in the groove of the feed-wheel before any motion is given to the lever  $o$ , by which the brake is moved, so as to move the feed-wheel. The shuttle-driver  $h$ , is attached to a slide or carriage  $a^1$ , which is moved by means of a bent lever  $b^1$ , actuated by a grooved cam  $c^1$ , fixed upon the driving-shaft. The form of the groove of this cam is developed in fig. 4. During the entire revolution of the cam it causes the shuttle-driver to be twice moved forward and backward,—each half of the cam being constructed so as to produce one backward and one forward movement of the shuttle. Into the groove of the cam a round pin or projection  $d^1$ , from the lever  $b^1$ , is caused to extend,—such projection being made of a diameter to correspond with the width of the groove of the cam. That end of the lever  $b^1$ , which is connected with the shuttle-driver, has an elongated slot  $e^1$ , formed through it,—a pin  $f^1$ , being passed through such slot and into the carriage of the shuttle-driver. By means of such slot and pin the lever is enabled, during its movements on its fulcrum  $g^1$ , to effect a reciprocating rectilinear motion of the carriage of the shuttle-driver. Besides having imparted to it a reciprocating rectilinear movement by means of the parts  $g^*$ ,  $h^*$ , of the cam, the shuttle-driver, after it has moved forwards so as to throw the shuttle into the loop of the needle, is moved backward a short distance by the part  $i^*$ , of the cam, and it remains stationary while the part  $k^*$ , of the cam is moving on the projection of the lever. The object of this back movement of the shuttle-driver is to open a space between the heel of the shuttle and the next adjacent arm of the shuttle-driver, in order to ensure the passage of the loop of thread over the heel of the shuttle when the thread is drawn into the cloth by the elevation of the needle.

In ordinary sewing-machines, wherein the shuttle is operated by a driver of the kind above mentioned or described, there is no short backward movement and interval of rest given to the driver immediately after it has thrown the shuttle forwards, and before it moves the shuttle entirely back through its race: the consequence is, that under such circumstances the thread of the needle, while being drawn off the heel of the shuttle, has to pass in contact with such heel and the shuttle-driver arm resting against it. This, of course, causes a movement of the shuttle and considerable friction on the thread of the needle; which friction is often so great as to render it difficult, if not impossible, to use cotton thread in the needle,—it being necessary to employ a stronger thread, made of silk or other suitable material. While the slight backward movement is being given to the shuttle-driver, in order to open or enlarge the space between the shuttle and next adjacent arm of the driver, the shuttle remains still in its race,—it being prevented from moving until the other arm of the shuttle-driver is brought into contact with the nose of the shuttle.

The patentee claims the improved mode of constructing and operating the brake or clamp contrivance,—the same consisting of two concentric surfaces or a circular groove  $a^*$ , formed, as described, in the face of the feed-wheel, in combination with a lever-clamp  $n$ , applied to operate or bear against the said two opposite concentric surfaces or sides of the groove, and carried by a lever  $o$ , and operated by a spring and a cam separate from that which operates the lever  $o$ ,—the whole being substantially as specified. He also claims, in combination with the parts  $g^*$ ,  $h^*$ , of the cam-groove or mechanism for imparting to the shuttle-driver its reciprocating rectilinear movements—the parts  $i^*$ ,  $k^*$ , of the cam-groove, or a mechanism or means of causing such shuttle-driver to have a backward movement a short distance, and interval of rest immediately after each forward movement of it, and just before the loop of thread is drawn off the shuttle,—the same being substantially as above described, and so as to open the space between the heel of the shuttle and next adjacent arm of the driver before the shuttle is moved backward,—such opening or enlargement of the said space being to facilitate the passage of the loop over the heel of the shuttle, as herein-before specified.

---

To ELMER TOWNSEND, of Boston, in the State of Massachusetts, United States of America, for improvements in machinery for sewing cloth, leather, or other material,—being a communication.—[Sealed 10th January, 1854.]

THIS improved sewing machinery is shewn in Plate XI., wherein fig. 1, is an under side view of the machine, and fig. 2, is a longitudinal vertical section. A, represents the main table or frame of the machine, having a curved arm or goose-neck B, extended upward and over the same,—such being for the purpose of sustaining the needle and the thread-carrier, and portions of the machinery by which they are operated. C, is the main driving-shaft of the machine, and D, is a secondary shaft, both of which are supported and made to revolve in suitable bearings E, E, and F, F. G, is a fly-wheel shaft, fixed upon one end of the main shaft.

This machine produces what is termed chain-stitch sewing; the same being effected in part by a needle H, constructed and made to operate in a peculiar manner. This needle is shewn in edge view at fig. 2, and in side view at fig. 3. The said needle is fixed in the lower end of a carrier or slide I, that is supported and made to work vertically in the arm B, and is moved upwards and downwards by a rocker-lever K, that plays upon a fulcrum L, and is worked by a grooved cam M, fixed on the driving-shaft C. The groove of the periphery of the cam represented at N, is so formed that during one entire revolution of the cam it not only causes the needle to be raised and lowered twice, but to remain stationary for a short time while the needle is elevated to its highest position; the same being in order to allow the thread-carrier O, time to lay the thread P, into the recess of the needle.

Instead of making the needle with a hook, in the usual manner in which those are made that draw the stitch through the cloth, it is constructed with a notch or recess a, which may be termed a reversed hook; the object of which in part is to receive the thread P, and force it down through the cloth during the descent of the needle. In connection with this needle a hook R, is employed, which is affixed to one end of a revolving shaft S, and is arranged below the table on which the cloth or material is supported while being sewn. The position of this hook is represented at figs. 4, and 5,—in the former figure as depressed to its lowest position, and in the latter as raised to its highest position. This hook works close to or against the needle, and so as to seize the loop of thread formed by the needle, and to hold the said loop

in a proper position for the needle to pass down through it when such needle next descends. This hook is worked in one direction by means of a cam  $\tau$ , operating against an arm  $\upsilon$ , that projects from the shaft  $s$ , and carries a friction-roller  $v$ , that rests on the periphery of the cam. The hook is moved in the opposite direction or downwards by means of a spring  $w$ , applied to a projection on the main frame.

By the above-mentioned method of constructing the needle, and the employment of the hook  $x$ , chain-stitch sewing may be performed with the finished or plain line of sewing on the upper side of the cloth, and under the inspection of the eye of the attendant, while the machine is in operation. The interlooping of the stitches takes place on the under side of the cloth,—their appearance on this side, when thus interlooped, being that of a chain of stitches. The sewing, as it appears on the upper side of the cloth, is termed the finished stitch or line of sewing. The thread-carrier  $o$ , before mentioned, consists of a bent lever working on a fulcrum  $x$ , and jointed to one end of a connecting-rod  $y$ , whose other end is jointed to the upper arm of an upright lever  $z$ , that turns upon a fulcrum  $b$ , and at its lower end is jointed to a slide  $c$ . From this slide a projection  $d$ , is made to enter the groove of the periphery of a cam  $e$ , fixed upon the driving-shaft  $c$ ; and, during its rotation, it effects the movements of the thread-carrier necessary to lay the thread in the notch  $a$ , of the needle.

The contrivance for holding the material to be sewn, and moving it along under the needle, not only longitudinally but laterally, will now be described. A top view of the holding-clamp is exhibited in fig. 6, and a longitudinal section of it in fig. 7. In this particular instance it is exhibited in the shape proper to enable it to hold the two pieces of leather which constitute the leg of a boot,—this clamp being adapted to the sewing of the side-seams thereof. The clamp is composed of two bars  $g, h$ ,—the upper one of which ( $h$ ) is to be forced towards the lower by means of clamping-screws or suitable contrivances, as seen at  $i$ , and  $k$ ; so that when the leather or other material is placed between the two bars  $g, h$ , it may be held in place by forcing the bar  $h$ , down upon it and towards the bar  $g$ . The bar  $g$ , is made to turn horizontally on a fulcrum  $l$ , arranged near one end, or any other convenient part of it, and projecting up from a long tooth-rack  $m$ , which is moved longitudinally by a gear-wheel  $n$ , fixed on a stationary shaft  $o$ , extending from a strut  $p$ , as shewn in fig. 2. This gear-wheel engages with a pinion  $r$ , fixed upon the hori-

zontal shaft *d*; and on this shaft there is a ratchet-wheel *s*, as shewn in figs. 2, and 8. The latter figure exhibits a side view of the ratchet-wheel, a rocker-lever *t*, a pawl or click *u*, its spring *v*, and the cam *w*, by which the rocker-lever is operated. The cam *w*, is placed upon the shaft *c*, and works against a roller or pin *x*, extended from the side of the rocker-lever *t*, which is placed upon the shaft *d*, and rocks freely thereon. This lever is disposed by the side of the ratchet-wheel *s*, and carries an impelling pawl or click *u*, whose impelling arm is kept in contact with the periphery of the wheel *s*, by a spring *v*. During the rotation of the cam *w*, it twice depresses the lever *t*, and thereby produces an intermittent partial rotation of the ratchet *s*. This gives motion to the shaft *d*, which, by means of the pinion *r*, conveys rotary motion to the gear *n*. A counter movement of the lever *t*, may be produced by a spring *y*, suitably applied to it and some part of the frame-work; while the extent of this movement may be regulated by a screw *z*, made to abut against some suitable part of the frame,—the stop screw being screwed through the lever, as seen in fig. 8. By means of the feeding-clamp, thus made and operated, the work or material to be sewn may not only be moved longitudinally in the line of sewing, but either towards or away from the needle, or under it laterally, so as to enable a workman to produce a curved or irregular line of sewing,—he laying hold of the clamp and guiding it laterally while it is moved longitudinally by the rack *m*.

The patentee remarks that he is aware that, in the performance of sewing by a chain-stitch sewing-machine, a hook has been employed in connection with a needle; the needle being constructed with a thread-hole made through it near its point, while the hook was arranged so as to stand and operate transversely to the axis of the needle; the barb of the hook being formed so as to turn and open the loop of thread, in order to enable the needle to enter it in the formation of another stitch. He therefore does not claim the combination of a hook and a needle, or such an arrangement, construction, and mode of operating the same. The needle in the above-described machine is formed with a notch or recess hook in its side, such as will enable it not only to leave the thread laid into it by a thread-carrier, but depress the thread through the cloth in the form of a loop, and discharge from it the loop after its formation, and during the withdrawal of the needle from the material sewn. The hook of this machine rotates or moves in a plane passing longitudinally through or parallel



to the axis of the needle. This enables the hook readily to seize or pass into the loop perpendicularly or thereabouts to the plane of the loop; and as it draws the loop forwards there is no twisting of the loop necessary in order to present it to the needle so that the latter may enter it. This is an important advantage when a waxed thread is employed in the needle; for if the thread is twisted, not only is more force required to draw it into the leather or material sewn, but the thread is subjected to more wear by the increased strain on it.

The patentee claims the arrangement and employment of a reversed hook recess *a*, made in the side of the needle, as described, in combination with the arrangement of the hook; so that, in order to seize the loop of the needle, it shall turn or move in or about in a plane arranged longitudinally with respect to the axis of the needle as specified. He also claims the application of the clamp (for holding the material to be sewed) to a separate carriage or rack-bar *m*, and so as to play or move laterally upon a pin or fulcrum *l*, arranged at or near one end, or in some other convenient part of the carriage or rack-bar; the same enabling the material to be sewed to be moved laterally or transversely during its longitudinal movements under the needle, as specified.

---

*To ELMER TOWNSEND, of the State of Massachusetts, United States of America, for an improvement in machinery for sewing cloth or other material,—being a communication.—*  
[Sealed 30th March, 1854.]

THE improved machine forming the subject of the present invention is shewn at fig. 1, Plate XI., in front elevation, and in longitudinal vertical section at fig. 2.

The machine, in performing the operation of sewing, employs two threads; and it uses a needle made with an eye near its point,—one of the threads being carried through the eye; and, when forced through the cloth, the thread is carried through in the form of a loop; the needle operating essentially the same as it does in machines which perform the operations of sewing by means of a needle and shuttle,—each carrying a thread. In connection with the needle of the machine, in order to pass the other thread through the loops formed by said needle, the patentee employs a device or contrivance, or a combination of devices or contrivances, essentially different in their operation from that of a shuttle; for the thread employed as a binding thread to the thread carried by the needle is used in a short piece, as the thread is em-

ployed in the sewing-machine invented and patented in the United States, by Frederic R. Robinson, on the 10th December, 1850, and also patented in England; whereas the shuttle of the shuttle sewing-machines carries a bobbin having a long thread.

A, denotes the needle, which is arranged vertically, and made to play up through the bench or table B, by means of suitable machinery. It has an intermittent reciprocating rectilinear motion, such as will cause it to pass up through the cloth, and remain at rest during the operation of passing a thread through its loop; and is next to descend so as to pass out of the cloth. The needle is fixed in the upper end of a vertical carrier or slide C, which is supported so as to slide freely upwards and downwards; and has a projection D, extending into the groove *a, a*, or a grooved cam E, fixed upon the main driving-shaft F, of the machine. The cam should be so formed as to cause the needle, after it has passed entirely upwards through the cloth, to move downwards a little, so as to bow out its thread, as is done in most, if not all, of the shuttle sewing-machines. The object of this is to allow a hook G, carried upon the lower end of a vibrating arm H, to pass through the loop, or between the thread and the needle. The arm H, of the hook G, extends, at an obtuse angle, from the outer end of an arm I, which is projected from a horizontal rocker-shaft K, supported by standards L, L. This rocker-shaft has a reciprocating motion imparted to it by means of an excentric M, fixed upon the driving-shaft F,—a connecting-rod N, and a crank O, extending from the rocker-shaft.

In connection with the hook G, a rotary forked thread-carrier P, is used. This thread-carrier has its axis disposed vertically and directly over the needle, or in line with it; and such thread-carrier is supported by, and made to rotate horizontally in a goose-neck or arm Q. Each tine of the fork P, is provided with a spring R, as shewn at fig. 3, which is a detached view of the rotary forked thread-carrier. During the operation of the machine this thread-carrier receives an intermittent rotary movement; that is to say,—while the hook G, is moved away from and made to approach the thread-carrier, the latter is revolved 180° of a circle; and it remains at rest during the time that the hook passes forwards into it and backwards out of it. This intermittent rotary motion is produced in part by means of two helix cams C, C, arranged on opposite sides of the shank D, of the carrier G, and acted upon by projections from the inner sides of a fork T, which

embraces the upper part of the shank of the carrier, and is jointed to the arm *i*. The lower part of this fork *r*, is guided in its vertical movement, and slides upon and between two vertical guides *v*, *v*. In connection with the helix cams *c*, *c*, two other and shorter helix cams *f*, *f*, are used. These are arranged on opposite sides of the shank *d*, and above the terminations of the before-mentioned helix cams; each of the smaller helix cams being disposed in respect to one of the larger, as shewn in the drawings. During the outward movement of the hook *g*, the fork *r*, is elevated; and when its projections are respectively carried into contact with the under inclined surface of the smaller helix cams, the pressure of such projections against such surfaces creates a short rotary motion of the forked thread-carrier sufficient to bring the projections directly over the larger helix cams, in order that, when the fork *r*, next descends, its projections shall be carried into contact with the larger helix cams, and thereby or during such descent cause a semi-rotation of the fork thread-carrier; such forked thread-carrier remaining at rest after the same, and until the projections of the fork *r*, are next brought in contact with the lesser helix cams.

When the machine is in operation, the thread which is worked by the hook *g*, extends from the cloth and passes under the spring of the rearmost tine of the thread-carrier, and lies over the path of the hook *g*, shewn at *t*, in fig. 1; that is to say, the thread is so extended from the cloth that, while the hook *g*, is passing into the thread-carrier, it will move under and lift that part of the thread *t*, which extends from the carrier down to the cloth or material undergoing the operation of being sewn. This is so arranged that the hook, in moving back, may seize the thread *t*, and draw it back with it through the loop of the needle *a*; it also draws it through the space between the front tine and the spring thereof of the thread-carrier,—such hook having previously entered said space during its passage into the thread-carrier.

Fig. 4, shews the relative positions of the needle *a*, the hook *g*, the rotary fork thread-carrier *r*, and the thread *t*, when the hook has entered, to the full extent of its motion, into the thread-carrier.

When the thread *t*, is drawn through the carrier *r*, it is left supported by the tine thereof, between which and the spring of the tine the hook has drawn it, while thus supported; and, during a portion of the descent of the needle, a semi-rotative movement of the thread-carrier takes place, and again presents the thread *t*, in a proper position to be seized by the

hook *g*, when again drawn backwards,—the hook, during its forward movement, being made to pass through the loop of the thread *A*. If the length of the thread *d*<sup>1</sup>, is less than the distance from the cloth to the extreme point of outward or backward motion of the barb of the hook *g*, the machine will perform the operation of sewing, and continue to draw the hook through each loop as it is formed by the needle, until the length of the thread *t*, extending beyond the cloth, is too short to pass from the cloth into the needle-carrier.

The thread for the supply of the needle *A*, is exhibited at *u*, and as passing from a bobbin *v*. The feeding-wheel of the machine is seen at *v*, and the cloth-presser at *w*,—they being constructed and made to operate as do similar devices in many other machines. During the performance of sewing by the machine, the forked thread-carrier winds the upper thread around the lower thread, and, in this respect, the machine performs sewing different from other machines.

The patentee claims the combination of the rotary fork thread-carrier *p*, and the hook *g*, as made to operate in connection with the needle *A*, and perform sewing therewith, substantially as hereinbefore specified.

---

*To JOHN WHITEHEAD and THOMAS WHITEHEAD, both of Leeds, in the county of York, for certain improvements in cutting tools, and in the working of iron, brass, and other metals, and wood, and other materials.*—[Sealed 1st November, 1853.]

THIS invention relates to the employment of certain arrangements of mechanism for facilitating the operations of turning cylindrical surfaces; of cutting the teeth of wheels; and of planing, slotting, and grooving metals, and other materials.

In Plate XII., fig. 1, represents in side elevation an improved arrangement of mechanism for turning shafting, and such like solid cylindrical work; so much only of the parts being shewn as will serve to explain the nature of the improvement. This part of the invention consists in fixing to the saddle of a slide-lathe or other lathe three or more cutting tools, to which a simultaneous backward or forward movement may be given, by means of a scrowl-screw or other mechanical equivalent, for the purpose of turning or cutting a larger or smaller diameter. *a, a*, is a circular plate having the bracket *b*, cast to it, for the purpose of being bolted to the traversing saddle of a hand or slide-lathe; or it may, if preferred, be fixed to the revolving

spindle of a lathe. *c, c, c*, are three guide pieces cast to the circular plate *a*, and intended severally to carry a slide *d*. These slides move in and out simultaneously, for the purpose of causing the cutting tools to approach or recede from their work as required. This action is effected by means of screws *e, e, e*, which connect the slides *d*, with the guide pieces. To each of these screws *e*, a bevil-pinion *f*, is keyed; and all of these pinions gear into the large bevil-wheel *g*. When, therefore, one of the screws *e*, is turned, its pinion *f*, will transmit an axial motion to the wheel *g*, and, through that wheel and the pinions in gear with it, turn the screws of the other slides *d*; whereby the three slides will be caused to move in or out at the same time. *h, h, h*, are three independent slides, which carry the three radial cutting tools *i, i, i*, for turning down the shaft *j*. *k, k, k*, are screws for moving out the slides *h, h, h*, separately, for the purpose of adjusting the turning tools to their required positions.

The second part of this invention consists in making a boring head to hold three or more cutting tools, which, by preference, are capable of simultaneous adjustment, by scrowlscrews, or any other mechanical equivalent, for the purpose of boring cylinders of various diameters. In fig. 2, *a*, is an axle to which a circular plate *b*, is keyed. This plate carries guides *c, c, c*, which are set radially, and are intended to receive slides *d, d, d*, in which the cutting tools *f, f*, are secured. The slides *d, d, d*, are provided with pins or projections which fit into a scrowl *e*, carried by the axle *a*. The tools are brought up to their work by turning the scrowl *e*; which movement causes the slides to approach each other. The simultaneous adjustment of the slides *d, d, d*, may be accomplished by means of screws, as shewn in fig. 1, in lieu of the scrowl *e*, if thought desirable.

The third part of this invention relates to the cutting of the teeth of spur-wheels, worm-wheels, and racks; and consists in the employment for that purpose of a steel worm having saw-teeth on its periphery; which worm is brought into contact with, and caused to revolve against, a plain wheel or plain rack, and thereby cut or mill out teeth in the same without the use of an index or dividing wheel. In fig. 3, *a*, is an arbor, on which the steel cutter *b*, is fixed; and *c*, is a plain wheel against which the rotating cutter is caused to bear, and cut out the teeth on the periphery of the plain wheel. This worm may be brought to bear against the plain wheel by an ordinary slide, and may be worked upwards or downwards, in or out, or at any angle also, by means of slides.

The fourth part of the invention refers to the planing, fluting, shaping, or slotting of various articles, and consists in the use of two or more pairs of uprights, and two or more pairs of cross slides opposite each other, for the purpose of carrying and bringing into operation tools which stand with their cutting points towards each other (or otherwise), and plane or cut continuously, as the planing-machine table or the cutters travel backwards and forwards; thereby keeping the machine always cutting, and at a uniform speed,—that is, cutting both backwards and forwards, up and down, or angularly.

The patentees remark that they are aware that cutting tools have been used in planing-machines with their points turned from each other, whereby a backward and forward cut has been obtained; but in these cases the cutters have been at a considerable distance from each other, and the planing-machine table has consequently been required to travel a considerable distance to bring the metal under operation; but according to this invention the points of the tools are arranged at a very short distance from each other, whether pointed to or from each other; so that, when the planing-table is set in motion, the two cutters operate almost as if they were one tool; thereby preventing the great traverse of the table in the first case, or, in other words, effecting a considerable saving of time in operating the machine.

Fig. 4, is a longitudinal elevation of a planing-machine, shewing so much of the machine as is necessary to elucidate this improvement; *a*, is an ordinary planing-machine bed; and *b*, the table, which travels backwards and forwards at one uniform speed; *c, c*, are the two uprights which may be either cast together or separately; *d, d*, are two cross slides which carry the cutting tools *e, e*, (standing opposite each other), and are provided with all the ordinary motions requisite for horizontal or perpendicular planing. The same mechanism is also applicable as a fluting-machine, for fluting rollers; an intermittent axial motion being in that case given to the work, by a ratchet-wheel and click, or otherwise.

Fig. 5, is a modification of the above-described arrangement; only one pair of uprights and one cross slide being in this case used. The same letters of reference refer to the like parts in figs. 4, and 5.

Fig. 6, is a further modification of the same. In this instance, the sliding-bar *a*, is fixed in the slotting-bar of a slotting or shaping-machine, and as the bar works up and down, the cutting tools *b, b*, cut alternately. The same may be also used in a planing-machine, by fixing the holding bar *c*, to the

cross slide of a planing-machine; whereby the cutters *b, b*, will be caused to act alternately.

The patentees claim, First,—the employment of three or more cutters mounted in one and the same saddle or head, and capable of acting simultaneously on the work, whether such tools be employed in cutting concave or convex surfaces. Secondly,—the use of worms having saw-teeth on their periphery, for the purpose of cutting the teeth of wheels and racks, as described. Thirdly,—the arrangement of cutting tools for planing, fluting, shaping, or slotting metals, wood, and other materials, as described with reference to figs. 4, 5, and 6, or any mere modification thereof, for effecting a quick succession of backward and forward cuts, as above explained.

---

*To WILLIAM LITTLE, of the Strand, for improvements in distilling or obtaining products from coals and bituminous substances.*—[Sealed 4th February, 1854.]

THE object of this invention is to distil or obtain products from coals and bituminous substances, by bringing in contact therewith highly-heated gases resulting from the passage and decomposition of air through fire,—these highly-heated gases to be used either alone or combined with steam. For this purpose the coals or bituminous substances to be distilled are placed in a chamber or vessel, which is connected to a fire-place by a flue or passage; and it is also connected with a suitable condensing apparatus, by a pipe or passage. Air is decomposed by passing through a red fire, and the products alone, or combined with steam, pass into the vessel or chamber containing the coals or bituminous substances to be distilled; by which means their volatile constituents are expelled, and pass into the condensing apparatus. The passage of the distilling agent, viz., the decomposed air and steam, is preferred to be accomplished by the aid of exhausting apparatus, though other means may be resorted to.

The figure in Plate XI., shews a section of a distilling-chamber, fire, and apparatus arranged or combined in a suitable manner for carrying out this invention. *a*, is a chamber of brickwork, or other suitable material, of a semi-spherical form. The bottom of the chamber is formed of perforated tiles or iron plates, in such manner that heated products from a fire and heated steam may be distributed below the bottom, and pass up amongst the coal or bituminous matters in the chamber *a*. The coal or bituminous matters

are fed into the chamber *a*, so as to fill it, or nearly so, at the opening *b*, which is closed when the process of distillation is going on; and there is an opening at *c*, where the residual matters are removed from the chamber *a*; which opening *c*, is also closed when the process of distilling is going on. *d*, is a fire-place, in which a coke fire is constantly kept;—the bottom of the fire-place is of fire-bars, or of perforated tile or plate. *e*, is a passage leading from the bottom of the fire-place *d*, to the space below the bottom of the chamber *a*: hence the products from the fire descend into the passage *e*, and thence up through the perforated bottom of the chamber *a*, amongst the coal or bituminous matters which are being distilled. At the upper part of the chamber *a*, is a pipe *f*, leading to a condenser, which may be in the form of a worm, or otherwise kept cool by a flow of water, and thence to a shaft,—the draft being assisted by a fan or other convenient means. *g*, is a steam-pipe passing through the fire, and thence under the bottom of the chamber *a*. By this means highly-heated steam may be introduced into the chamber *a*, and amongst the charge of coal or bituminous matters therein. By this arrangement it will be evident that the distillation of the coal or bituminous matters in the chamber *a*, will depend on the heated products from the fire, or those products aided by steam. It will be evident that the degree of speed at which the products from the fire are caused to pass amongst the coal or bituminous matters, may be varied, and from time to time accommodated to the progress of the distillation, and by a suitable throttle or other valve the quantity of steam admitted may be also regulated.

The patentee claims the combination, herein described, for distillation, or obtaining products from coal and bituminous substances.

---

*To SYDNEY SMITH, of Hyson Green Works, near Nottingham, for improvements in valves or apparatus for regulating the passage and supply of fluids.*—[Sealed 26th January, 1854.]

THIS invention consists in forming valves of portions of spheres, fitted and ground to seats, which are also portions of spheres,—such valves moving on spherical joints or on axes, in such manner that each valve is in a state of balance; so that, when closed, and the pressure of fluid is on one side, it has no tendency to open, by reason of the state of balance; but such valve will open with facility when acted on by an instrument in connection with a float, or by a handle, or other



instrument connected to the valve—the axis being the fulcrum—or, when required, to the spindle or other connection forming the axis of the valve, as in steam or water-taps, in consequence of the valve opening one half with the flow of the fluid, and one half against the flow of the fluid.

The figure in Plate XII. represents a valve constructed and combined according to this invention. *a*, is a valve, the face of which is composed of part of a sphere, and it fits into a seat also spherical. This valve moves on a spherical joint *b*, connected to the valve *a*, by a stem *c*,—the spherical joint having its bearing in a hollow or spherical bearing in the cross-bar *d*, as shewn. By this combination and construction of parts the valve, when pressed on, will have no tendency to open, by reason of its being in a state of balance; but it may be readily moved, notwithstanding that it is subject to considerable pressure, by means of an arm *e*, fixed to the spherical joint, or it might be to the stem, or to the valve itself; according to the use to which the peculiar valve may be applied.

The patentee claims the combination of parts herein described.

---

*To JULIAN BERNARD, of Regent-street, in the county of Middlesex, gent., for improvements in the manufacture of boots and shoes; part of such improvements being applicable to the manufacture of garments.*—[Sealed 3rd January, 1854.]

THIS invention relates, first, to a novel mode or modes of securing the uppers or fronts to the soles or bottoms of boots and shoes. This is effected by securing, first, a welt or strip to the upper, before such upper or welt is secured to the sole; or the welt is attached first to a sole; or a sole is split along and around its edge, and the edge is raised so as to form a substitute for a welt, and is connected, by stitching or otherwise, to the uppers, either with or without a welt, or by means of another strip or welt, according to the description of boot or shoe to be made. If the boot or shoe is to be turned, a second welt need not be employed, unless such welt be attached to the outer edge of the sole. If a second sole or double sole be applied outside, it is desirable, but not necessary, to employ a second welt, which may be either applied to the upper first, at the same time, or together with the upper, while being connected to the first or inner sole: and such last-mentioned welt is more particularly for the purpose of uniting an outer or additional sole to the boot or shoe. In some cases, it is

proposed to turn over the outer edge of the last-mentioned strip or welt, so as to cover it, and afterwards attach an outer sole to it.

The second part of the invention relates to a novel mode or modes of cutting the various parts and materials of which boots and shoes and garments are composed. This is effected in two distinct ways, the first of which is as follows:—Two spindles, working in suitable bearings, one underneath and one above a table, are geared together; and on these spindles are placed two shear-edge discs, which are caused to revolve in contrary directions. One of the shear-edges may be stationary, and may be round or straight, and only one revolving disc employed.

Another mode of performing the same operation consists in employing an endless band of steel for cutting such parts; such band being passed round three drums,—one above, one below, and another at the end of a table; or otherwise suitably placed.

In Plate XI., fig. 1, is a transverse diagram section of an upper leather and single sole of a boot or shoe, before being turned, with the welts secured to the single sole by stitching through and through. Fig. 2, represents a similar view of another arrangement, where the edge of the sole is split all round to form a welt, to which the upper is attached. Fig. 3, represents a transverse diagram section of a boot or shoe-sole with the upper attached thereto, and the welt secured previously to the upper, by means of cement, or otherwise: in this figure a double sole is represented. Fig. 4, represents another mode for securing the uppers to the inner sole, which is split all round, as hereinbefore described; and fig. 5, is a similar view of the mode of constructing boots or shoes by turning the welt over the edge of the inner sole, so as to cover the edge of the same, and afterwards securing the outer sole thereto.

The welt having been secured to the upper (either by hand or machinery-sewing), the upper (a welt being previously attached thereto) is placed over a last, having an inner sole upon it, as at fig. 3; the edge of the upper *b*, being turned over the edge of the inner sole *c*, and secured thereto by any suitable adhesive solution or cement. The outer sole *d*, is then laid over the inner sole, and secured to the other parts by means of the welt *a*. In fig. 1, the welt *a*, is secured to a single sole by being stitched thereto through and through, as shewn at *b, b*; and the upper *c*, is also secured to the welt by stitching through and through, as at *d, d*; and, when

stitched, the boot or shoe is turned or reversed in the ordinary manner, and further shaped and finished upon a last. In fig. 2, the welt *a*, in place of being attached to the sole *b*, is formed thereon by splitting the sole all round, and turning up such split portion, to which the upper *c*, is secured, by stitching through and through, as at *d, d*; and the boot or shoe is then turned. The boot or shoe shewn at fig. 3, is not supposed to have been turned or reversed. Another mode of making single-soled boots or shoes is shewn at fig. 4, where the upper *a*, is secured to the split portion or welt *b*, of the single sole *c*. The stitching is effected through and through the material, as shewn at *d*; but as the sole is split, such stitching will not shew on the under side of the sole when the edges are well pressed down in the manner shewn at *e*.

The patentee observes that he does not confine himself either to single or double-soled boots or shoes; the principle of this portion of the invention being the so arranging the modes of securing uppers to soles, whether such soles be single or double, that the operation of stitching may be more readily effected.

Fig. 5, shews the mode of giving a finished or ornamental appearance to boots or shoes by turning over the welts *a*, so as to form a species of binding on the edge of the inner sole *b*. This welt is made wider than usual, to allow of such turning over, and is previously secured to the upper *c*. The upper with its welt is then secured to the inner sole by cement, or by stitching through and through, as hereinbefore described. The protruding or overhanging edge of the welt is now doubled down and back over the edge of the inner sole, as at *a, a*; and the outer sole is secured thereto by stitching, or otherwise. The uppers may be composed either of cloth or fine leather, or any other substitute; and the soles may consist of gutta-percha or other suitable material for such purpose; and such parts may be partly stitched or united by any known cement or solution.

In the second part of the invention, which relates to the cutting of materials, fig. 6, represents a side elevation and partial vertical section of one of the cutting-machines,—a portion being broken away for the sake of compactness. *a, a*<sup>1</sup>, are two spindles, which work in suitable bearings *b, b*<sup>1</sup>, and are geared together by the spur-wheel and pinion *c, d*. *e, f*, are two shear-edged discs or cutters, which are secured to the extremities of their respective spindles by the nuts *g, h*, and are so placed that their shear or cutting edges will come in contact with and slightly overlap each other. Motion is com-

municated to the lower spindle  $a^1$ , by the grooved pulleys  $i, i$ , and a suitable driving band, or by gearing, if found desirable. The lower disc  $f$ , is made to project slightly above the surface of the small plate  $j$ , which is slotted for that purpose, and is inserted flush with the top of the table  $k$ . On motion being communicated to the apparatus by the pulleys  $i$ , the lower cutting-disc revolves; whilst the upper one  $e$ , will revolve at a slower rate, and in a contrary direction. The material to be cut is then spread out on the table  $k$ , and pushed gently forward between the two discs, which effectually sever the parts either in a straight line or in a curved direction, according to the cut required. In place of both discs or cutters revolving at different speeds, they may both revolve at the same speed, or one of them may be entirely stationary.

The patentee claims, with regard to this part of his invention, the employment of a revolving shear-edged disc or cutter working in conjunction with a second disc or cutter; which second disc or cutter may either be stationary or have a rotatory motion communicated thereto. Fig. 7, is a side elevation and partial section of another cutting-machine; and fig. 8, is an enlarged side view of a portion of a serrated cutter, employed for cutting strong leather; or a smooth or knife-edged blade may be employed. The blade or cutter  $a$ , shewn in dots, consists of an endless belt or band of steel, rivetted or otherwise joined together, which is passed over and carried by the three pulleys  $b, c, d$ . The pulley  $b$ , is supported in the end of the overhanging bracket  $e$ , which is bolted or otherwise secured to the bed-plate or table  $f$ . The second pulley  $c$ , is carried by the shaft  $g$ , which works in the fixed bearings  $h$ , secured to the under side of the table: this shaft is fitted with a driving-pulley (not shewn in the drawing), and serves as the driving-shaft of the cutter. The third pulley  $d$ , acts not only as a carrier, but also as a tension-pulley for keeping the steel belt well stretched. This is effected by fitting the pulley on to the stud-centre  $i$ , which is carried in a sliding-piece working in the horizontal slot or groove  $j$ , in the fixed bracket  $k$ . The pulley  $d$ , is traversed backwards or forwards along the slot  $j$ , by means of the screw  $l$ , and winch-handle  $m$ , at the end of the table. The bracket  $e$ , is made hollow, and a moveable cover is fitted on to its side to enclose entirely the portion of the steel blade which is contained therein: this cover is removed in fig. 7, to shew the cutter, and interior of the bracket.  $n$ , is a slotted tube or guard screwed, at  $o$ , into the head of the bracket, which is also slotted at  $p$ , to admit of the entrance of the endless belt over the several car-

rying-pulleys *b, c, d*. The tube or guard *n*, reaches nearly to the surface of the table,—there being just space enough beneath it to admit of the passage of the material to be cut. *g*, is a small metal plate let into the table flush with the top thereof; and to this plate is attached the bearing of the small grooved steadying pulley *r*, which serves also to guide and support that portion of the blade immediately beneath the cutting point. The cutting edge of the blade, when plain, may be kept sharp by the employment of an emery buff, or other means brought in contact with it as it revolves: and the same arrangement is also applicable to the discs in the last-described cutting-machine. On giving a rotatory motion to the driving-shaft *g*, the belt *a*, will revolve; and any materials that may be brought in contact with its cutting edge will be cut or severed in a straight or curvilinear direction, according as they may be fed in.

The patentee claims, in the arrangement of apparatus shewn at fig. 7, the use of a flexible or endless cutter for cutting cloth, leather, and similar materials; such cutter or band being kept stretched by any suitable mechanical arrangement, either by a weighted lever or otherwise.

---

To JOHN KERSHAW, of the City of Dublin, Ireland, engineer, for improvements in steam-engines.—[Sealed 30th January, 1854.]

THIS invention relates to the heating of the feed-water, previous to its entering the boiler of locomotive and other engines, and consists in the employment of a wrought or cast-iron vessel or chamber, placed behind or in front of the fire-box, or in any convenient position between the pumps and the tender or tank. Running from end to end, and along the top of this chamber is a pipe, perforated on its under side with small holes, and in immediate communication with the supply pipes from the tender or tank. In the centre, and immediately below the perforated water pipe, and for about one quarter its length, is fitted the nozzle of a steam-pipe or pipes, in connection with the lower portion of the blast-pipe of the engine. This nozzle is of a T-shape, and open at both ends, from which the exhaust steam issues. In the smoke-box the steam-pipe is turned upwards in front of the tube-plate, so as to be above the level of the water in the tender; and it is so arranged, by an extension of surface, as to take advantage of any amount of the waste heat of the smoke-box.

It passes directly through the ash-pit and beneath the fire-bars, with which it is in close proximity, thereby keeping the steam heated or surcharged to a certain extent, previous to its exit by the nozzle into the condensing box or heating chamber. When the feed is turned on, the water descends in a shower through the perforations in the pipe before mentioned, and falls through the jets of steam immediately beneath it, which becomes condensed, and so imparts to the feed-water a certain amount of heat. This heated water then remains in the lower portion of the chamber or reservoir, and is supplied to the boiler therefrom by the usual feed-pipes, opening from the bottom of the reservoir and connected to the pumps. A regulating cock is fitted to the exhaust steam-pipe or pipes, for regulating the due supply of steam in accordance with the supply of water used by the engine; and also a steam blow-cock is fitted to the feed-pipes, for carrying off the waste steam from the boiler into the tender. In case the heating-chamber or condensing-box should be allowed to get full of steam, through the steam-cock being left open, when the water-cocks are shut, a discharge-cock is fitted to the chamber, which is either self-acting or under the control of the engineer. It is obvious that these arrangements are equally applicable to locomotive, marine, and stationary engines, and to boilers of every class.

In Plate XI., fig. 1, represents, in vertical longitudinal section, a portion of the back of a locomotive engine, with a heating-chamber or condensing-box attached, and shewn in transverse section; and fig. 2, is a sectional plan of the condensing-box, looking up from the under side. *a*, is a wrought-iron chamber or box, situated behind the fire-box *b*, and attached, by arms, or otherwise, to the foot-plate *c*, or to the framing of the engine. A pipe *d*, perforated on its under side with small holes, runs from end to end along the top of this chamber. The perforated pipe *d*, communicates by means of the branch or supply-pipes *e*, *e*, with the tender or tank of the engine immediately below; and in the centre of the perforated pipe *d*, is fitted the T-shaped nozzle *f*, of the steam-pipe or pipes *g*, in connection with the lower portion of the blast-pipe. The other end of this steam-pipe, in the smoke-box, is turned upwards, as before described, so as to be above the level of the water in the tender. This steam-pipe passes in close proximity with the under side of the fire-bars *h*, as shewn at fig. 1, whereby the steam becomes, to a certain extent, superheated, before entering the condensing-box *a*. On turning on the feed-water, it descends through the per-

forations in the pipe *d*, in the form of a shower, and falls through the two jets of superheated steam issuing from the T nozzle *f*, beneath: this steam becomes condensed, and imparts at the same time a certain amount of heat to the feed-water. The heated feed-water is supplied to the boiler by the pipes *i*, *i*, and ordinary feed-pumps, which are not shewn. A regulating cock is fitted to any convenient part of the steam-pipe *g*, and placed under the control of the engineer; whereby the supply of steam may be regulated according to the amount of water required to feed the boiler. *j*, is a discharge-cock and pipe, also under the control of the engineer, or it might be self-acting, by which any superabundant steam in the condensing-box *a*, may be allowed to escape. *k*, *k*, are mud-cocks or plugs, for cleaning out the condensing-box, and running off any deposit contained therein. *l*, is a steam blow-off cock, for blowing the waste steam from the boiler to the tender when requisite, or at a station. The patentee remarks that he does not confine himself to any particular dimensions or form of heating-chamber or condensing-box, nor to its exact position under the engine, as both of these conditions must, of course, depend upon the arrangement of the working parts of the engine, and other local circumstances. By the arrangement hereinbefore described, it will be obvious to the practical man that all the feed-water required for the engine will be heated to boiling or nearly boiling point; and that a saving, moreover, in the weight of water requisite to be carried will be effected by the employment of the condensed steam,—both these objects being effected without the aid of mechanical power.

The patentee claims, First,—the general arrangement and construction of apparatus for heating the feed-water of steam-boilers, as hereinbefore described. Second,—the system or mode of heating the feed-water of steam-boilers, wherein the condensation of so much of the exhaust steam is effected as will give to the whole of the feed-water required by the engine a temperature of about 212°; such result being obtained without the expenditure of any mechanical power. Third,—the employment of the water in the boiler more than once, by reason of the condensation of the steam produced in imparting heat to the feed-water; such condensed steam intermixing with the feed-water.

---

To DAVID HULETT, of High Holborn, for improvements in gas regulators for regulating the supply of gas to the burner,—being partly a communication.—[Sealed 4th January, 1854.]

THE object of this invention is to regulate the supply of gas as it issues from the main to the burner, and prevent fluctuation in the height of the flame, notwithstanding any difference that may occur in the pressure of the gas in the main.

The improved apparatus consists of a cast-iron vessel with inlet and outlet passages for the admission and emission of the gas: the inlet is covered by a valve, the edge of which dips into a groove containing mercury: this renders the joint perfectly gas-tight without impeding the motion of the valve, which is hung in such manner as to move with the slightest variation of pressure. The valve is attached by a rod to a short cylinder, the lower part of which is open, and dips into a channel or groove containing mercury. The cylinder covers and surrounds the inlet passage: thus, as the gas flows from the main through the inlet of the regulator, it exerts an upward pressure on the cylinder, which is adjusted by means hereinafter described, to admit the requisite quantity of gas for the supply of the burners. If the pressure of gas issuing from the main be increased, it lifts the cylinder which closes the valve; but the consumption by the burners quickly reduces the pressure within the regulator: this causes the cylinder to fall and open the inlet-passage.

In Plate XII., fig. 1, is a vertical section of the regulator arranged for use. *a*, is a cast-iron cylindrical vessel or box; *b*, is the inlet; and *c*, the outlet passage. The passage *b*, is closed by a valve. *d*, is a recess cast in the lower part of the box *a*, and forming a small cistern or reservoir to receive mercury when the regulator is adjusted for use. *f*, is a channel or groove for containing mercury: this communicates with the channel *g*, which conveys the mercury into the cistern or recess *d*.

The mercury or other suitable fluid is poured into the regulator through the tube *g*<sup>1</sup>, by which it is conveyed to the recess *d*, and channels *f*, *g*. *h*, is the valve-seat, which is secured by screws to the box *a*. *i*, is the valve, the rod *k*, of which is jointed at *l*, to the seat *h*. To the outer end of the rod *k*, is jointed a small rod or spindle, which supports the cylinder. A groove or channel *n*, is formed in the valve-seat *h*, which surrounds the valve: when this is filled with mercury or other suitable fluid, the valve dips into it, and forms



a gas-tight joint. When the valve is secured to the box *a*, the joint of the valve-rod is within the recess *d*, and below the surface of the mercury, as also is the joint of the rod *m*. This arrangement prevents the clogging of the joints, arising from the deposit of oily and bituminous matters. *m*, is the rod or spindle secured at one end to the valve-rod *k*: at the upper part is a nut *o*, upon which the cylinder *p*, rests. The cylinder is made of iron, or other suitable material, and open at the bottom. It is secured to the rod *m*, by a nut, which is screwed down upon the cylinder; and discs or washers of leather are placed between the nuts to render the joint gas-tight.

At the top of the rod *m*, is an eye, to which is fastened a metal bar *r*, by a pin passing through the lugs *s*. The bar *r*, is supported by a rod *t*, which passes through the lug *u*; and the ends of the rod *t*, are supported by the pins or brackets *v*, screwed in the edges of the box *a*. This bar *r*, is perforated, to receive a small weight *w*, by which the pressure of the bar *r*, on the cylinder *p*, is regulated. If it be placed at the back of the fulcrum *u*, or to the left-hand side, as shewn, the pressure may be wholly taken off the cylinder *p*; and it will be gradually increased as the weight is moved along the bar. When the regulator is to be adjusted for use, after attaching it to the inlet and outlet-pipes, the channel *p*, the recess *d*, and the grooves *f*, *g*, are to be filled with mercury, by pouring it into the pipe or tube *g*<sup>1</sup>, until the metal is nearly level with the top: a nut is then screwed in the pipe *g*<sup>1</sup>, the gas turned on, and the weight *w*, put in a position so as nearly to balance the cylinder *p*, when the gas is pressing it upward. Any increase of pressure from the main will lift the cylinder *p*, which causes the valve *i*, to descend, and shut or partially close the inlet until the pressure becomes uniform. On the contrary,—should the pressure from the main decrease, the cylinder will descend and open the inlet-passage to a greater extent. The regulator being properly adjusted as before described, the cover *x*, is put on to secure the internal parts from injury: the apparatus will then require no further attention.

A modification of the foregoing is represented in vertical section at fig. 2. It consists of a cylindrical box *a*, *a*; of which *b*, is the inlet, and *c*, the outlet-passage. Into the bottom of the vessel is screwed the piece of brass *d*, or other metal, the inside of which is grooved out, as shewn at *d*<sup>1</sup>. The valve *e*, is hollow, and slides over the piece of metal *d*; and three or four steadying pins project from the inside of the valve to keep it equidistant from the metal *d*. The valve is attached to a rod *f*, to which the cylinder *g*, is secured, as in the arrange-

ment before described. The lever *h*, and other working parts, being above the cylinder, are not within the influence of the gas. The pressure of the lever on the cylinder is adjusted in the same manner as before described. When the cylinder is lifted, the valve is drawn upward, and the angular edge of the aperture *i*<sup>1</sup>, in the partition *i*, dips into the groove formed round the top of the valve, by the edge *e*<sup>1</sup>, rising a short distance above the curved top. The groove is filled with mercury, to make a gas-tight joint when the edge of the partition *i*, dips into it. One or more apertures are made in the upper part of the valve to maintain an equality of pressure on both sides of the valve. The direction of the gas as it passes through the regulator is indicated by arrows.

Fig.-3, is a vertical section of another arrangement of regulator: *k*, is the inlet, and *l*, the outlet-passage; *m*, is a grooved piece of metal containing mercury; *n*, the valve connected to the rod *n*<sup>1</sup>; *o*, the lever; and *p*, the lever-supports. When the valve is lifted by a variation of the pressure, the curved edge of the metal *q*, dips into the mercury; thus stopping the passage of the gas. The action of the other parts of the apparatus is similar to the foregoing. In all cases the regulators are to be provided with covers, as shewn in the figures. The material preferred for the manufacture of the valves is malleable iron coated with tin, in order that the mercury surrounding the valve may adhere to it when it descends, and make the joint gas-tight.

The patentee claims the construction of the apparatus for regulating the flow of gas, substantially as herein described and shewn.

---

*To WILLIAM and JOSEPH CLIBRAN, of Manchester, in the county of Lancaster, machinists, for certain improvements in apparatus for regulating or governing the supply or pressure of gas as it is conducted from the main to the burners.—[Sealed 1st March, 1854.]*

THIS invention consists in a novel construction and arrangement of apparatus for obtaining an even amount of gas whilst passing from the main to the burners for consumption, and consequently, an equality of light, whatever may be the variation of the pressure of the gas. The regulation of the supply from the main to the burners is effected by means of a slide-valve or disc-valve (the slide-valve being preferred), formed by two corresponding surfaces placed together between the branch inlet-pipe from the main and the branch outlet-pipe to the burners.

These slide-valves have suitable apertures for the passage of the gas, so arranged that, when the apertures are open, the gas will pass freely; but as, by shifting the position of the slide-valve, the apertures may be gradually closed or opened to the full extent, so the quantity of gas allowed to pass from the main to the burners is regulated or governed. The continuous opening and closing of the gas-passages in this slide-valve is effected by the variable pressure of the gas acting within a small gasometer, after the gas has passed the valve; so that as the pressure increases, the gas rising within the gasometer, will cause it to rise, and, by any simple arrangement of connection or gearing, to open or close the apertures for the flow of the gas, and thus regulate the supply to the burners for combustion.

In Plate XII., fig. 1, exhibits a slide-valve of peculiar construction, the upper portion of which *a*, forms the frustum of a cone. Around this the collar *b*, fits, and rises and falls; thereby opening and closing the orifices or openings *c, c, c*, of the frustum-shaped slide-valve. Fig. 2, represents a similar valve; and the same letters of reference refer to corresponding parts. The action of this improved apparatus is as follows:—The flow of the gas from the main enters through the tube *d*, directly to the centre or interior of the valve, not in its line of direction operating on any one particular portion of the surface of the valve or other mechanical equivalent, as heretofore has been the case, but in the interior of the valve; distributing an equal pressure on all sides (that is,—radiating from the centre of the said valve). From the interior of the valve the gas passes through the perforations or openings *e, e, e*, in the direction of the arrows, into the small gasometer or chamber *f*, connected by two small pendants *g, g*, with regulating screws at their upper ends, to the collar *b*. The gas from the gasometer *f*, then passes the openings shewn by dotted lines at *j*, and, through the pipe *h*, to the burners: in both figures the valves are shewn open. Supposing now the gas to be at a higher pressure within the valve than desirable to be supplied to the burners, the gasometer *f*, in accordance with its previous adjustment, will raise or elevate the collar or valve *b*, thereby partially closing the outlet space and regulating the equal pressure at the burners; but should the pressure within the valve, and, of course, in the main, become less, then the gasometer *f*, must fall, and the free flow of gas be allowed proportionate to such fall. It will be evident now that, from the peculiar construction of the valve, whatever the pressure

of gas in the main, it must be equally diffused over the entire inner surface of the collar *b, b*, or of the shutting-off part of the valve; whereby extreme regularity of action is maintained.

The patentees claim, First,—the peculiar construction, employment, and use of an apparatus for regulating or governing the supply or pressure of gas as it is conducted from the main to the burners; having a central slide-valve through which the gas radiates, and thereby causes an equal pressure on all parts of the slide-valve and gas-holder, and also produces the required perpendicular lift of the same, in the manner and for the purposes above particularly set forth and described; such valve being placed in the regulated gas, in contradistinction to the valves of all other known gas-regulators, the valves of which have been invariably placed in the current of the irregular gas; by which means a valve is obtained which offers no resistance either to the action of the regulating surfaces or to the gas-holder. Secondly,—the peculiar construction or arrangement of an apparatus for governing or regulating the passage of gas, in which the necessary regulation of the gas and the supply of the same for distribution to the burners is effected in one chamber, which causes its operation to be more sensitive to the variations of pressure in the main, or to the shutting off of the supply of gas to the burners.

---

To JOHN CHISHOLM, of Holloway, in the county of Middlesex, chemist, for improvements in the purification of gas.  
[Sealed 20th February, 1854.]

THIS invention consists in combining or mixing the peculiar red earthy or ochry-looking substances found mingled with peat, and the subsoil of peat, with hydrate of lime, or the mixed hydrates of lime and magnesia obtained from magnesian limestone, and employing it in the dry-gas purifier. This red earthy or ochry substance is composed chiefly of the oxides and salts of iron and manganese; and it is principally to these metallic matters that the purifying agency of the compounds is due: therefore, the greater the quantity of these oxides this earthy matter contains, the better it is adapted for the present purpose. And although the exact proportion of lime to be added is not material, yet the greater the amount of metallic matters there may be contained in the red or ochry earthy matters aforesaid, the more lime or lime and magnesia must be used. It is preferred to use for every three parts by weight of metallic matters in this earthy matter,

one part of lime by weight. Instead of the above red earthy matter, the patentee sometimes employs in the same way and proportion the fine red sandy gravel so general around London, in the neighbourhood of chalk beds, or the red clay which is so common around Rugby and other districts; or the phosphate or subphosphate of iron, known by these names to all geologists, and common in many boggy districts. All these or any of them are used precisely in the way or combination described with respect to the red earthy peat matters; and when these substances or mixtures, or any of them, have ceased to purify the gas from sulphuretted hydrogen and other impurities, their powers may be again, in part or altogether, renewed or restored, by passing or forcing through them a current of air, or even by merely exposing them to the air; after which they may be used over and over again, or many times in succession.

The patentee claims, Firstly,—the use of the silicious earthy matter herein described, containing oxides of iron and oxides of manganese, and found under bogs and in alluvial deposits, and treated in the manner hereinbefore described for purifying gas. Secondly,—the use of ferruginous gravel, which overlies and is intermingled with chalk formations, treated as hereinbefore described for purifying gas. Thirdly,—the use of the ferruginous clay or loam of the alluvial formation, treated as hereinbefore described for purifying gas. And, lastly,—the use of the phosphate and subphosphate of iron which exists in the tertiary formation, treated in the mode and manner hereinbefore described for purifying gas.

---

To EDWARD MASSEY, of *Tysoe-street, Clerkenwell*, for *improvements in ships' logs, known as "Massey's patent ships' logs."*—[Sealed 22nd February, 1854.]

THIS invention relates to certain improvements upon what are known as Massey's patent logs.

In Plate XII., fig. 1, represents a front elevation of a log complete, with the improvements attached thereto; fig. 2, is a side elevation with the lower part in section; and fig. 3, a back view of the same. *a*, is the universal joint; in order to permit the free action of which, an opening is cut in the front plate *b*, as represented by the dotted lines *c, c*, which leaves the joint exposed in front as well as at the back, where there has heretofore been no covering or protection. In order to enclose it and prevent the liability of oakum, weeds, and other

matters collecting on the joint during its rotatory motion in the water, a covering-plate *d*, is constructed and applied, which affords the necessary protection, and at the same time permits the free action of the joint *a*, as will readily be seen by reference to the sectional part, fig. 2. The side plates *f, f*, are extended down to the bottom of *b*; and an inclined plate *g*, is applied at the back, which affords a similar protection at that part of the instrument.

The second part of this invention refers to an improvement in fixing the cord by which the rotator *h*, is attached to the tail of the universal joint *a*, as will be seen in figs. 2, and 3: it consists in the insertion of pins *i, i*, through the tail-piece *k*, in order to afford a better security for the lashing. The strands of the rope are laid in the longitudinal grooves in the end of the tail *k*, (an end view of which is seen at fig. 4,) and lashed round in the ordinary manner. The pins *i, i*, being of a length to be flush with the surface of the lashing, or to project slightly beyond, they prevent the possibility of the lashing being drawn off, and consequently afford a better hold for the strands of the cord. As a further improvement, the cord is attached to the rotator in a similar manner, as shewn at fig. 5, which is the top of the rotator detached. The pins *i, i*, give facilities for holding the lashing, not to be attained by projecting bands alone surrounding the tail, as at *l*. The cord *m*, is secured by lashing wrapped round the strands laid against the stem, as before described; and wax or other adhesive matter is applied to the lashing, as is well understood.

The third part of this invention refers to a method of dispensing with the universal joint altogether. In order to effect this, a tail-piece *n*, is attached to the rotating shaft of the log, as seen in the partial back view, fig. 6. This tail-piece is in all respects such as before described, and forms a stiff continuation of the rotating shaft: the cord *m*, is lashed directly to this, without the intervention of the universal joint,—the cord itself answering the purposes of that joint. In order to protect the spindle *n*, from weeds and other extraneous matters, a guard-plate *p*, is fixed to the front plate *b*, of the instrument. This plate is carried down below the tail *n*, as at *q*, to protect it when set down, or when it strikes against anything in handling. A similar guard-plate may also be applied at the back of the instrument. Instead of applying the guard-plate *p*, the front plate of the instrument may be carried down, or otherwise made to answer all the purposes of the guard-plate. In order to afford a better security for the rope by which the log is dragged, a thumb-screw *s*, is introduced, to hold the

spring-plate *t*, as seen at figs. 1, and 2, instead of the pin usually employed to restrict the action of that spring. In addition to the tendency of the spring *t*, to keep close to the eye *w*, of the log, and thereby prevent the strap *v*, becoming disengaged, the plate *t*, is screwed up by means of the thumb-screw *s*, which entirely prevents the possibility of the log becoming disengaged; and it is easily unscrewed when that is required to be done.

The patentee claims, First,—the application of guard-plates *d*, and *g*, and otherwise protecting the universal joint in ships' logs, as hereinbefore described and shewn in figs. 1, and 2. Secondly,—the application of transverse pins or cogs or radial projections on the tail of joint or otherwise, for fastening the cord to the rotator and register instrument. Lastly,—the arrangement represented at fig. 5, for dispensing with the universal joint altogether.

---

*To WILLIAM WRIGHT and GEORGE BROWN, of Newcastle-upon-Tyne, iron-founders, for improvements in cupolas; which improvements are also applicable to smelting and other furnaces.*—[Sealed 31st January, 1854.]

THIS invention relates to various arrangements and constructions of cupolas, blast furnaces, and apparatus for melting or smelting metals and metallic ores, whereby superior economy in the manufacturing cost and rapidity of production are secured. Instead of blowing the air into the melting contents of the cupola or furnace, either in a cold state or primarily heated, by passing through a separate heating apparatus, the cupola or furnace is so formed that it may act as the heater for its own blast. Under such modification the lower portion of the cupola or furnace is formed with receiving chambers, so contrived that they may hold a mass of melted metal which has descended from the body of the cupola or furnace, and thus act as the heating surface for the cold air supply. Thus the external cold air is first blown into these chambers, and, being there heated, it passes off into actual contact with the melting mass of material under treatment. As applied in the construction of smelting or blast furnaces, the cold air is first blown into the lower part of the body of the furnace, and it is then passed into heating-chambers formed in the bottom and sides of the furnace-body. It is then conveyed into the furnace at a level slightly above that of the blast-hole, and made to pass through the coke and metal with which the furnace is charged.

In Plate XII., fig. 1, is a vertical longitudinal section of the improved cupola, as constructed with the view of carrying out this invention; and fig. 2, is a sectional plan of the same. Fig. 3, is a vertical longitudinal section of a smelting-furnace, as built for smelting iron, with heating-chambers, according to this invention; and fig. 4, is a sectional plan of the same. In the cupola shewn at figs. 1, and 2, the air enters from the blowing-engine or blast-fan by the pipe *a*,—passing thence through the cupola wall at *b*, into the central portion *c*, of the bottom of the cupola. This primary air-receiving portion of the cupola being thus filled with air under pressure, which air is restrained from passing upwards by the presence of the mass of materials contained above, a partially descending current necessarily arises. Hence the air diverges downwards, and passes out at the part *c*, through the vertical division-walls *d*, by the archways *e*, which are open to the base line *f*, of the cupola bottom. The air thus reaches and enters the chambers *g*, which, together with the central portion of the cupola base, have their bottoms covered to a greater or less extent with melted metal. The arrows indicate the course of the air, shewing how it circulates to the extreme end of the chambers *g*, and returns along the arched tops *h*, of these chambers. The air is by this means heated to a very high temperature, and in this condition it passes onwards and re-enters the main body of the cupola, by passing through the walls *d*, by the lateral ports *i*. Here it permeates the melting mass of metal and coke.

The upper portion *j*, of the cupola may be built to any desired form; and as the melted metal comes down it gradually accumulates in the bottom, and is tapped or withdrawn, as required, through the aperture *k*. The heating-chambers may be filled up, more or less, with sand, when small castings are to be made. The slag-hole is at *l*.

In the smelting-furnace, shewn at figs. 3, and 4, the external contour is not at all interfered with,—the main body *a*, being a pure cylinder all the way down. The air from the blast-engine is supplied by the four pipes *b*, which enter the furnace body at regular distances asunder. This quadruple current thus keeps up a constantly uniform air pressure in the central space *c*, beneath the mass of melting materials; and it can only escape through the four lateral archways *d*, alternated with the four entrance thoroughfares. In this way the air is made to pass in contact with the surface of the melted mass of material on to the bottom *e*, of the furnace, as well as with that contained in the archway passages *d*, and



their external corresponding chambers *g*. This heated air then rises up through the chambers *g*, and returns, towards the body of the furnace, through the converging thoroughfares *h*, and penetrates the melting mass of metal and materials at *i*, by issuing through the ports *j*. The tapping takes place through the outlet *k*, whilst the bottom of the furnace can be cleared out through the slag aperture *l*. It will be obvious to the practical man that this system of self-heating furnaces may be carried out with various forms of chambers and apparatus, and that it is applicable to all forms of melting or reducing furnaces.

The patentees claim, First,—the general arrangement and construction of cupolas and smelting-furnaces for the self-heating of the air-blast, as hereinbefore described. Second,—the application and use in cupolas, smelting and other furnaces, of receiving-chambers, or sections, for the reception of the metal or mass of material under treatment, to form heating surface for the air-blast. Third,—the system or mode of heating the air-blast of cupolas and furnaces, by passing the air over the surface of or in contact with the melted or heated mass of material, as brought down from the cupola or furnace body. And, Fourth,—the system or mode of working furnaces, wherein the air is first passed through the fire, or through the body of materials of the furnace, and then through furnace-heating chambers, or in contact with the heated metal or materials brought down from the furnace body.

---

*To JOHN ELDER, of Glasgow, engineer, for improvements in marine steam-engines.*—[Sealed 25th February, 1854.]

THIS invention consists in making such a disposition of the essential parts of horizontal direct-action condensing marine engines for screw steamers as to secure greater compactness of arrangement, and simplicity of action of the moving parts than heretofore. To effect this the patentee places the steam-cylinder of the engine, or both steam-cylinders of a pair of such engines, on one side of the screw-shaft, and the air-pumps and condenser on the other side, as commonly practised; but the improvement essentially consists in employing two or more air-pumps for each engine, and disposing them sufficiently far apart in lines parallel, and on each side of the axis of their respective steam-cylinders, to permit the connection-rods, guide-blocks, and cross head-frame to pass between them, and to be supported by them. The arrangement preferred is to employ four rods for each steam-piston, and

to connect them in a suitable cross head-frame, beyond which the rods are prolonged, so that the lower pair, one on each side, serves as the air-pump rods, and the upper pair serves the like purpose for the feed and bilge-pumps. But this arrangement or distribution of those pumps may be varied at pleasure, in so far as that the upper piston-rod on one side, and the lower one on the other side, may become the air-pump rods, and the other diagonal pair will then serve for the feed and bilge-pumps.

In Plate XII., fig. 1, is a longitudinal section through one of the engines; fig. 2, a front view of the cylinder and plummer-blocks, and cross section of the condenser, taken through the valves; and fig. 3, is a half plan and section of one of the engines. These figures refer to a pair of horizontal direct-acting engines, coupled at right angles as usual, and furnished with ordinary long D-valves, actuated by such a link motion as that commonly employed in locomotive railway engines, and controllable by the engineer, on a starting platform between the condensers, by means of suitable reversing gear. The pistons, in this example, are seventy-two inches diameter and three feet stroke. They are fitted with spring packings in the ordinary way, but have broad flanges cast on the junk-rings *b*, to lessen the wearing of the cylinders as much as possible. The cylinders are formed with recesses *c*, (of about half an inch) at each end, to receive any dirt or grit that may accumulate, and prevent it from acting detrimentally on the pistons. The pistons are each furnished with four piston-rods *d*, *d*, passing through stuffing-boxes cast on the front of the cylinder, and they are made fast by cotters *e*, in malleable iron sockets *f*. Into these sockets are also cotted the rods *g*, which extend in continuation of the four piston-rods *d*, to the feed and bilge-pumps *h*, and *i*, (of which the two upper rods are the plungers) and to the air-pumps *j*, *j*, of which there are two to each steam-cylinder. On the sockets *f*, two side-rods *k*, are made fast, by means of nuts *l*, screwed on the ends of the sockets passing through the cross tails of the side-rods *k*; and the extremities of these rods are again made fast, by means of nuts, to the cross heads *m*, which work in cast-iron sliding-blocks *n*, fitted, by boring, in suitable parallel ways formed in the cheeks of the condenser. This cross-head *m*, carries one end of the connecting-rod *o*, by which the action of the piston is transferred to the crank *a*, of the propeller-shaft in the ordinary manner. This shaft is carried in the plummer-blocks *p*, which are cast hollow and in one piece, and thus serve to bind the cylinders and con-

condensers together by means of the bolts *q*; which end is further secured by a strong cast-iron exhaust-pipe *r*, extending between the valve-casing and condenser. The plumber-blocks *p*, also carry the weigh or rocking-shaft *s*, for transmitting motion from the link *t*, to the steam-valve.

To illustrate the action of the engines (of which the novelty mainly consists in the arrangement of the pumps and condenser) let it be assumed that the steam, which has done duty in the cylinder, escapes by either port into the exhaust-pipe *r*, communicating with the condenser *u*, and that, being condensed by the injection water from the pipe *v*, it falls down by the two central passages *w*, shewn more fully in the sections, figs. 4, to 7, inclusive. The hot water then fills the spaces below the foot-valves *x*, through which it is drawn on the recession of the air-pump plunger, and fills the air-pump barrel. By the succeeding stroke it is forced through the delivery-valves *y*, into the passages *z*, from which it is delivered through the ship's side by means of the discharge-pipe *a*<sup>1</sup>. By this arrangement a higher vacuum is produced than is commonly attained, in consequence of the water having to rise only a very small distance to enter the pump; for in the passages from the condenser it must always stand about the level of the foot-valves, and no air can enter the pump. The action is adjusted by making the spaces between the foot and discharge-valves each equal to the capacity of the pump-barrel.

The patentee claims the special combination and arrangement hereinbefore described.

---

To JOHN JOBSON, of *Litchurch Works, near Derby, in the county of Derby, iron-founder*, and ROBERT JOBSON, of *Holly Hall Works, near Dudley, in the county of Stafford, iron-founder*, for *improvements in the manufacture of moulds for casting metals*.—[Sealed 1st February, 1854.]

IN moulding according to this invention, a pattern of the article to be cast is prepared, which may be of iron, wood, or other suitable material. Thus, if it be required to prepare moulds for the casting of a plate of the sectional form shewn at fig. 1, Plate XII., a pattern is prepared, and two moulds are made from the same, in sand or plaster of Paris, or other suitable material, which will present the forms shewn in figs. 2, and 3.\* An empty moulding-box is then placed on the

\* This invention formed the subject of a paper communicated to the Institute of Mechanical Engineers, and reported in our last number. We now give a more detailed account of the process.

mould, fig. 2, and an alloy of lead and tin, or zinc and tin, or other suitable metal or alloy of metals is poured in, until the mould is covered thereby. When the plate deviates considerably from a flat surface, a core or cores of sand or other suitable material may be introduced at parts, so as to displace a portion of the fluid metal, and render a less quantity of the same sufficient to cover the mould. Pins or screws, or other projecting pieces, attached or not to the moulding-box, as may be most convenient, are introduced into the metal, and when it has solidified, the box is filled with Roman cement or other suitable material, so as to form a ramming-block with a metallic face or surface, fig. 4; or the blocks may be made entirely of metal or alloys of metal. Another ramming-block, fig. 5, is made in a similar manner from the mould, fig. 3. A moulding-box is placed on each of these ramming-blocks, and sand or loam is rammed in, and the two sand moulds thus made are placed together, as in fig. 6, to form the complete mould for receiving the melted iron or other metal,—suitable passages being left in the sand for the purpose. The frames or boxes are provided with pins and holes which fit corresponding holes and pins in each other, and in the ramming-blocks.

Instead of introducing cores to displace a portion of the metal, as above mentioned, an additional pair of moulds, of sand or other suitable material, is sometimes prepared, as shewn at figs. 7, and 8, from the original pattern, and a portion of the sand is scraped away, as shewn by the lines *a, a*, and *b, b*. These moulds are then placed in contact respectively with the moulds, figs. 3, and 2, as shewn in figs. 9, and 10, and the alloy of lead and tin, or other metal or alloy of metal, is poured into the same, through suitable passages made in the sand or other material for that purpose. The plates thus made—when backed with Roman cement or other suitable material, after taking out the sand, but before the boxes have been separated or the plate displaced—form the ramming-blocks shewn in figs. 11, and 12, which are employed in a similar manner to those shewn in figs. 4, and 5.

It will be seen that the partings of the sand, or the surfaces of the sand which come in contact with each other in the complete mould, fig. 6, as well as the mould of the article itself, are thus moulded on metallic surfaces. The moulds are thus made with great accuracy, and also with great facility, as the moulder's skill is not required to produce a good parting.

In lieu of pouring melted metal into the mould to form the face of the ramming-block, an empty box is sometimes

fixed upon the mould, figs. 2, or 3, (which, for this purpose, may be of plaster of Paris); and this box is luted on in a water-tight manner, and filled with a solution of sulphate of copper or other suitable metallic solution, and the copper or other metal, or mixture of metals, is deposited on the surface of the mould by means of the electrotype process. The mould is previously prepared with wax, or other suitable material, to prevent it from absorbing or being acted upon by the metallic solution; and it is rendered capable of conducting electricity by means of black-lead or other suitable conducting material, as is well understood. When a sufficient coating of copper or other metal has been thus deposited, the solution is removed, and the platé backed, if necessary, with lead and tin or other suitable metal or alloy of metals, and the box filled up with Roman cement or other suitable material. Screws or pins, or pieces of metal, are placed on the surface while the metal is depositing; and these pieces of metal become attached to the deposit, and serve to connect it firmly to the cement backing. The ramming-blocks thus made are similar to those shewn in figs. 4, and 5, and are employed for forming the sand moulds in a similar manner.

If a box of iron or other material, capable of being injuriously acted upon by the sulphate of copper or other metallic solution, is employed, it is to be coated with grease on the inside, or otherwise protected from the action of the solution. A wooden box, lined with pitch or with gutta-percha, may be employed while the metal is being deposited; and this box may be removed and replaced by an iron box when the deposit has acquired a sufficient thickness, and the iron box is then filled up with the backing, as hereinbefore described.

The patentees also prepare ramming-blocks consisting of lead and tin or other metals, or partly of metal and partly of Roman cement or other suitable backing, and having the original pattern attached to one of such ramming-blocks, in a similar manner to that described in the specification of Mr. John Jobson,—patent dated October 2nd, 1852. In this mode of proceeding, the two moulds, figs. 2, and 3, are made from an iron or metal pattern, fig. 1. This pattern is then laid on the mould, fig. 2, after attaching some hooks to its back, and an empty box is placed over it, and an alloy of lead and tin, or zinc and tin, or other suitable metal or alloy of metals, is poured into the box so as to cover the pattern. Hooks or pins are placed in the liquid metal, and when it has cooled, the box is filled with Roman cement or other suitable backing. The ramming-block, fig. 13, is thus produced. Or

the box may be completely filled with the melted metal if preferred. The other ramming-block is made as above described, or as described in the specification before referred to, by making a reverse mould in plaster or sand, from the mould, fig. 3, and again taking a cast from this reverse mould in cement, which will then produce a ramming-block of the form shewn in fig. 3.

The patentees claim the manufacture of moulds, for casting metals, by means of ramming-blocks constructed in manner hereinbefore described, either entirely of metal or with metallic surfaces firmly attached to a backing of Roman cement or other suitable material; which metallic blocks or surfaces serve for moulding the partings of the sand or other material forming the mould, as well as for moulding the form of the article itself.

---

*To ALFRED VINCENT NEWTON, of the Office for Patents, 66, Chancery-lane, in the county of Middlesex, mechanical draughtsman, for improved machinery for crushing or grinding and amalgamating quartz rock and other substances,—being a communication.*—[Sealed 5th January, 1854.

THIS invention relates to a novel construction of machinery for extracting metals from ores, and consists mainly of an annular trough formed of iron, and one or more edge or crushing-wheels placed in the trough and held in position by an axle, which is jointed to and turns on a centre pin,—thereby steadying and supporting the edge-wheel in its place as it rolls around in the trough, and also allowing of a sufficient rise and fall in the wheel in running over the quartz.

In the figure in Plate XII., *a*, is the foundation or bed-plate on which the machinery is placed; *b*, *b*, is the annular trough into which the material is thrown for crushing; *c*, *c*, are the crushing-wheels, mounted loosely on the axle *f*; and *d*, *d*, are cog-wheels connected to the inner face of the crushing-wheels. *e*, *e*, is a ring of teeth attached to the trough *b*; *g*, is a centre pin stepped into the bed-plate *a*, and to it the axle of the crushing-wheels is jointed; *h*, *h*, is an annular amalgamating trough or pan for containing mercury, and for receiving the overflow from the trough *b*; and *i*, *i*, are spouts for carrying off the water and refuse material.

The axle *f*, carries at its extremities a cog-wheel *k*, into the teeth of which gears a pinion *l*, on a vertical shaft *m*, provided with a belt-pulley for receiving rotary motion from the motive power machinery.

It will now be understood that, by applying motive power to the shaft *m*, the shaft *f*, will be driven round upon its centre pin *g*, and with it the crushing-wheels *c, c*; which wheels will keep their position in the trough as well as revolve on their own axis. As the cog-wheels *d, d*, are affixed to the crushing-wheels *c, c*, and are of a less diameter, and both are compelled to make the same number of revolutions in going round in the trough, it will be seen that the crushing-wheels must necessarily slide on their periphery in the trough to an amount just proportionate to the superiority of their diameter over the cog-wheels *d, d*. The material is thrown into the trough *b*, by the operatives, in lumps four inches in diameter and under, and a stream of water is let into the trough—the wheels being set in motion. As the material is ground fine it flows out over the outside of the trough *b*, with the water, and falls into the trough *h*, and from thence runs out of the spouts *i, i*, and is conducted wherever it is required. The pin *g*, is loose in its step; so that when one of the wheels *c*, passes over a large lump of quartz rock or other substance, the pin *g*, will rise, and thereby permit of the rise and fall of the crushing-wheel.

In some cases quicksilver is put into the trough *b*, and also into the trough or pan *h*, in which other wheels may be used, solely for the purpose of amalgamating. When this is not done, the ground quartz may be run off and amalgamated in the usual way.

In order to prevent the material which is being ground from passing off out of the trough *b*, before it is ground sufficiently fine, a hoop *n*, may be raised up to any required height and secured there by a band or any other device most convenient. The object of the trough *h*, surrounding the trough *b*, is to receive the ground quartz and water as it flows over at any and every point all around the trough *b*. This is considered to be important, as it allows a free discharge of the water and quartz from the trough *b*.

The patentee claims the application of the gearing, in the manner described, for the purpose of causing the crushing-wheels to slip and give a grinding motion as described; and also the application of the pan or trough *h*, for the purpose set forth. He also claims attaching the pin or centre (on which the shaft *f*, vibrates, and around which the crushing-wheels rotate) at or near a point on a line with the lower edge of the wheels *c, c*, so that the vibration is hardly perceptible; whereas, if it were on a line with the centre of the crushing-wheels, it would not allow of the necessary rise and fall of the wheels without making a joint in the shaft.

To BENJAMIN WESTON WELLS, of *Windmill-lane, Camberwell, in the county of Surrey, floor-cloth manufacturer, for improvements in printing floor and other cloths.*—  
[Sealed 18th February, 1854.]

THE object of this invention is to obtain, when printing floor-cloths or other fabrics, such as table-covers ornamented with oil, turpentine, or varnish colors, that kind of impression of the pattern known in the trade as “solid work.”

In carrying out this invention, it is preferred to operate upon two or three pieces at a time; but when working only upon one piece, a pad is employed at starting; and by means of the several pattern blocks, which together complete the design, an impression is imparted alternately to the cloth which is intended to be covered with the pattern, and to the pad which is placed adjacent thereto. The colors used are those ordinarily employed in the manufacture of floor-cloths; and the mode of imparting color to the printing-blocks is by pressing them upon pads, tables, or other smooth surfaces covered with wet color. When the imprint of the design is completed, by applying the blocks successively in the usual way, the ground of the cloth will, as in all ordinary printing, shew between the spots of color which make up the pattern. In order to cover the ground, and at the same time make good any deficiencies which may chance to exist in the imprint on the cloth, a block, ribbed on its under surface with parallel lines, is pressed down upon the pad which contains the imprint of the perfect design, and an inverted impress of the pattern is thus obtained on the ribbed surface of the block. This block is now brought into contact with the pattern on the cloth, and, by heavy blows or pressure applied to the back of the block, the moist colors are spread on the cloth; thereby completely hiding the ground, and at the same time remedying any deficiencies which may have occurred in the transfer of the colors from the pattern-blocks to the cloth. After the ribbed block has taken up sufficient color to produce a good impression of the pattern upon it, the use of the pad is no longer required. Floor-cloths printed after this manner may be made to imitate Brussels carpet very closely, by ribbing the blocks with straight parallel lines, for the lines of paint formed by the pressure of such blocks will give the effect produced by the lines of loops in the carpet.

A more smooth and perfect impression may be obtained by the use of a second pressing block, the counterpart of the first; that is,—having raised surfaces corresponding to the



sunken surfaces of the first block; which second block may impart color or pressure only to the printed cloth. When two or more pieces are worked together, the pad may be dispensed with; for the ribbed block may borrow color from the several pieces, and so obtain a good impression of the pattern, which it must continue to retain in order to ensure good sound work.

As a modification of the above-described process of obtaining solid work, the patentee proposes to employ two pressing blocks, the straight or wavy lines or dots on the face of one of which will fall between or just over the edges of those on the other. These blocks are applied alternately to a pad, sieve, table, or cloth, containing an impression, in moist colors, of the complete design intended to be transferred to the cloth; and the impression received on to the blocks is transferred to the cloth or other fabric in the manner before explained. In this case, however, the impression on the pad, sieve, or table, will require to be constantly renewed with fresh color by the ordinary printing blocks.

By the application of this invention it will be understood that the necessity for two sets of pattern blocks, and consequently the double printing at present adopted for covering the ground or producing solid work, is avoided.

The patentee claims imparting pressure to the printed pattern of floor and other cloths while the colors are in a moist state, by means of a block or blocks containing a counterpart in colors of the printed pattern; whereby solid work is obtained, and the necessity for a double set of pattern blocks, and consequently double printing from pattern blocks, is avoided.

---

*To ANTOINE EDOUARD PASCHAL LE GROS, of Paris, for improvements in preserving timber and generally all kinds of wood.—[Sealed 15th March, 1854.]*

THESE improvements consist in preserving timber and all kinds of wood, by means of a cheap chemical compound which does not destroy the fibrous structure of wood or otherwise injure it. For this purpose the patentee employs a solution of muriate or hydrochlorate of manganese, resulting from the manufacture of chlorides of lime, and of the bleaching liquid called lye, or water of javelle, or chloride of potash; which residue has no use at present, and is treated like waste by the manufacturers of those articles. This salt, containing a great proportion of acid, is neutralized, by admixture with a sufficient

quantity of chalk, carbonate of lime, or oxide of alumina. The salt thus reduced to a neutral state, gauges, by the areometer used for concentrated acids, from  $30^{\circ}$  to  $35^{\circ}$ , and may therefore easily be carried to the place where it is to be applied as a solution containing three parts by weight of water to one of acid. The acid in the residue may also be neutralized, and the ferruginous matter in it precipitated, by means of oxide of zinc. A double salt of manganese and of zinc is thus obtained, which has the same (or superior) preserving qualities as the double salt of manganese and of lime produced as above described. This double salt of manganese and zinc is very efficiently applied for absorbing the effluvia of putrid or putrescent matter. For preserving wood, the solution obtained in either of the two ways described is poured into a trough; and the immersion of the logs or pieces of wood is effected by placing them vertically in the trough, in such manner that they are steeped in the liquid to about three-quarters of their length. The wood is thus subjected to the action of the solution during a length of time varying from twelve to forty-eight hours. The solution rises in the fibres of the wood, and impregnates them by capillary force alone, without requiring any mechanical action; whilst a horizontal immersion, under the same circumstances, has been found to produce no satisfactory effect. The timber which has been thus prepared is rendered incombustible, and the changes of temperature have no influence upon it: its preservative effect is more lasting than that of metallic sulphates, which weaken the ligneous fibre, and impart to wood brittleness and a tendency to crack and warp under the action of heat. It will be easy, and, in some cases, convenient, to combine the good effects of creosote with those of either of the two solutions obtained as above described. For this purpose a variable quantity of some tarry or resinous oil is dissolved in concentrated sulphuric acid; and this solution is then diluted with water, and mixed in suitable quantities with the solution of muriate of manganese, when required.

The patentee claims preserving all kinds of wood or timber, or organic matter, by means of a solution of a double salt of manganese and of lime, or of a double salt of manganese and of zinc, used both either alone or with an admixture of creosote, obtained in the manner above described.

---

To STEPHEN HOLMAN, of Colney Hatch, in the county of Middlesex, engineer, for improvements in machinery for raising and forcing fluids; part of which improvements is also applicable to the guiding of piston-rods generally, and other rods.—[Sealed 23rd March, 1854.]

THIS invention relates, firstly, to a novel arrangement of pump-valves and water passages, to which easy access is permitted for the replacement or re-adjustment of the valves. To attain this end, and otherwise to produce a simple and efficient pump, the inlet and outlet-valves are arranged in pairs, one above the other, in the same box or chamber,—the front plate or cover of which is removable on the withdrawal of screw-bolts which hold it in its place.

The lower valves act alternately as inlet-valves, by the ascent and descent of a piston or plunger, which works in a cylinder communicating with the valve-box. This valve-box is divided into two compartments, one of which is connected with the upper end, and the other with the lower end of the pump-cylinder; and, by this means, the water or other liquid supplied to the pump will be forced out (both at the ascent and descent of the piston) at one or other of the outlet-valves alternately.

In Plate XII., fig. 1, represents the improved pump in longitudinal sectional elevation; fig. 2, is a section taken in the line 1, 2, of fig. 1, and looking towards the right-hand; fig. 3, is a sectional plan taken in the line 3, 4, of fig. 1; and fig. 4, is a partial front elevation, with the front plate of the valve-box removed, to shew the arrangement of the valves. *a, a*, is a cylinder, in which a piston *b*, works. This cylinder opens at its upper end directly into the compartment 1, of the valve-box, which box is divided into two compartments by a partition *c*. The lower end of the cylinder is connected to the compartment 2, of the valve-box by the channel or pipe *d*. An opening for the admission of fluid is provided in the bottom of each compartment of the box; and these openings are governed by their respective valves *e, f*. The fluid is supplied by the inlet-pipe *g*. Above the valve-box is a chamber *h*, which communicates with both compartments of the valve-box by means of openings in the top of the box, which are governed by the valves *i, k*. Into this chamber *h*, the water is thrown by the action of the piston or plunger *b*, and it is discharged therefrom through the outlet-pipe *l*.

The action of the pump is as follows:—Suppose the piston to have made an up-stroke, and thereby filled one set of pas-

sages with water, and to be now making its downward stroke, the water will pass up the inlet-pipe *g*, lift the valve *e*, in the compartment 1, of the valve-box, and flow on to the top of the piston *b*. The continued downward movement of the piston will force the water that is below it up the channel *d*, whence it will escape into the compartment 2, of the valve-box. This moving column of water will then lift the valve *k*, and escape into the chamber *h*, whence it will be discharged through the exit-pipe *l*. When the piston has performed its downward stroke it will draw water through the inlet-pipe *g*, into the compartment 2, of the valve-box, and simultaneously it will force up the column of water that rests upon its upper surface, cause it to close the valve *e*, open the valve *i*, and enter the chamber *h*, whence it will be discharged, in like manner to the former column, through the outlet-pipe *l*. The quick repetition of this action of the piston will effect a copious and continuous discharge of water at the outlet-pipe. To permit of the refitting of the valves with leather, or of the ready removal of any extraneous matters that may have entered the pump, the valve-box is provided with a removable face-plate or cover, which is secured in its place by screw-bolts, and, when removed, will give ready access to the valve-box. This cover closes also an opening made in the chamber *h*, for the purpose of permitting access to the upper valves, without removing that chamber from its seat.

This invention relates, secondly, to a mechanical arrangement for communicating motion to the piston-rod of the pump without the use of parallel guide-rods. This arrangement is shewn attached to the pump at fig. 2. The piston-rod of the pump is jointed to a vibrating hand-lever *n*, which rocks on a fixed fulcrum-pin *o*, that passes through a straight slot in the hand-lever. This slot is made to permit of the lever moving in the direction of its length as it is rocked to actuate the piston-rod. By regulating this longitudinal movement of the lever, so that it shall be equal to the versed sine of the arc which the lever, if working on a fixed point, would describe, the piston-rod will continue to work in the same plane. This traverse of the lever is effected by passing a fixed guide-pin *p*, through a suitably-shaped groove *q*, formed in or carried by the lever *n*. This arrangement is applicable to the guiding not only of pump and other piston-rods, but also of reciprocating rods generally.

The patentee claims, First,—the general construction and arrangement of pump, as above set forth, or any mere modification thereof, wherein a great working capacity is obtained in

a small compass, and at a comparatively small cost; and particularly the construction of valve-box as described, whereby ready access is permitted thereto. And, Secondly,—the arrangement, above described, for actuating piston and other reciprocating rods.

---

*To THOMAS WICKSTEED, of Leicester, civil engineer, for improvements in the manufacture of sewage manure.—*  
[Scaled 26th January, 1854.]

IN carrying out this invention the patentee precipitates the fertilizing matter from sewage water by mixing it with lime and finely-divided charcoal, in the following manner:—The charcoal is reduced to fine powder, and thoroughly mixed with lime water, so as to obtain a uniform cream or milk of lime and charcoal. This mixture is added to the sewage water by causing a stream of the mixture to flow into a stream of the sewage water by means of two pumps,—one of which pumps in the aforesaid mixture, while the other pumps the sewage water. The pumps work together, and are of such proportions that they may deliver the proper relative proportions of each liquid. The proportions may be varied according to the richness of the sewage water, and the strength of the mixture of lime and charcoal. It is convenient to make the lime and charcoal pump of about one thirty-fifth of the capacity of the sewage water pump, and to provide it with an adjustable lever, so that the proportion of liquid raised by it may be varied. The proportion of the lime and charcoal may also be varied by varying the strength of the mixture, which is kept in constant motion, by means of an agitator, to prevent the separation of the lime and charcoal from it, and to preserve its uniformity. When the sewage water is not raised by a pump, the lime and charcoal mixture may be allowed to flow into it through a valve or cock, properly adjusted so as to deliver the necessary quantity.

The united stream of sewage water and lime and charcoal mixture is conducted through a cistern or cisterns containing an agitator or agitators, by which the whole is thoroughly mixed together, and it then passes into reservoirs in which a precipitate soon subsides to the bottom. This precipitate is the sewage manure, which is collected and dried by exposure to the air with or without the aid of heat, or by means of centrifugal machinery, as described in the specification of letters patent granted to the present patentee, 24th February, 1851.

The charcoal above mentioned may be ordinary wood char-

coal or charcoal made from peat, tan, or bones, or lamp-black, or the refuse charcoal obtained in the manufacture of prussiate of potash or other description of carbonized matter. It must, in all cases, be reduced to fine powder, and thoroughly mixed with the water. The lime and charcoal may be separately mixed with water, and introduced by separate pumps, but it is preferred to mix them together, and to employ the same pump for introducing them. By proceeding in the manner hereinbefore described, the charcoal and the lime are thoroughly mixed with the sewage water; whereas, if powdered charcoal were simply scattered upon the sewage water in the reservoir, the mixture would be very imperfect and unequal.

The patentee claims the mixing lime and charcoal with sewage water, in manner hereinbefore described, in and for the manufacture of sewage manure.

---

To GEORGE FERGUSSON WILSON, of Belmont, Vauxhall, for an improvement in the manufacture of candles and night-lights.—[Sealed 16th January, 1854.]

It has been long known to chemists that castor oil, when treated with hyponitric acid, or nitrous acid, or sulphurous acid, solidifies, and what is called palmine is produced; but such product of castor oil has never been applied in the manufacture of candles and night-lights. Now this invention has for its object the employment of palmine or its acid in such manufacture, either alone or in combination with other matters suitable for being used in making candles and night-lights. For this purpose the palmine or its acid is washed and boiled in water, and then, when desired, subjected to a suitable process to separate the more solid from the more fluid part.

Palmine, particularly when used after pressing, is suitable for hardening tallow and other fatty matters which require it, when used in the manufacture of candles and night-lights; and such matters may be melted and mixed together in proportions according to the degree of hardness desired to be obtained in the candle or night-light material; and wax may also be combined with it, with a view to reduce the cost of candles made of wax. Palmine may be thus used in place of or in combination with the matters which have heretofore been combined with wax when making candles or night-lights. The patentee also employs palmine in the manufacture of composite candles and night-lights; for which purposes it is

mixed with hard fat acid, in the proportions, by preference, of about half and half, or, for cheaper composite candles, the palmine and soft acid fatty matters are used, such as distilled acidified palm oil, or a combination of these and unacidified fatty matters,—the fatty acid matter being in the proportion of about half. The patentee remarks, that although he has thus stated proportions, he does not confine himself thereto; and although he generally employs palmine, its acid may be used in place thereof with unacidified fats or oils, or with other fatty acids. He claims the application of the product of castor oil, called palmine and palmic acid, in the manufacture of candles and night-lights.

---



---

### Scientific Notices.

---

#### INSTITUTION OF CIVIL ENGINEERS.

November 14th, 1854.

The paper read was “*On the means of avoiding smoke from boiler furnaces.*” By Mr. W. WOODCOCK.

The author commenced by explaining the nature of smoke as existing in furnaces, the cause of its formation, its component gases, and the temperature at which they became inflammable; and then pointed out a method of preventing the evolution of opaque smoke by simple and apparently effective means. It was stated that ordinary pit coal, under the process of destructive distillation, gave off various volatile substances, some of which were gases, such as hydrogen, marsh gas, olefiant gas, carbonic oxide, &c.; these and others existed in the furnace only in a gaseous state, becoming liquid or solid when in the external air; and of such coal-tar was composed: and amidst them the carbon, in minute subdivision, was held in suspension,—giving to the smoke its sable hue. All these gases were combustible at given temperatures, provided a certain amount of oxygen was present. It was then shewn that the air containing this oxygen, if imparted to the gases after leaving the fuel on the bars, must be administered so as not to reduce the temperature of the gases below their flame-points.

The formation of smoke, or visible carbon held in suspension, was stated to depend entirely upon the insufficiency of the supply of oxygen in the furnace, as the heat of the furnace would cause the various gases to be given off more rapidly than their combustion could be supported by the quantity of oxygen passing through the fire-bars in the same period of time; this evil being much ag-

gravated by the heat of the air as usually supplied from the ordinary ash-pit, generally ranging from 200° to 300° Fahr., and the air at that heat containing less oxygen, by about one-third, than at the usual atmospheric temperature; and, consequently, the combustion of the fuel to which it was supplied must be one-third less perfect.

The simplest means of preventing the formation of smoke were shewn to be by providing for an ample supply of oxygen in a condensed state in the form of cold air, to the fuel on the fire-bars, and by administering such further supply of oxygen to the heated gases as might be necessary for their complete combustion whilst in contact with the boiler; this latter supply being given at such a temperature as would insure the successive ignition of the gases as they were evolved. Thus, by establishing nearly perfect primary combustion, the quantity of smoke evolved was shewn to be reduced to a minimum, of which no visible trace ever reached the summit of the chimney.

The apparatus by which this desirable end was attained, was described as consisting of two parts, each being the addition of a very simple apparatus to the ordinary boiler furnace. The first of these was a double set of thin iron bars lying horizontally in the direction of their length parallel to each other, immediately beneath the grate in the ash-pit. Each set of bars resembled a Venetian blind in its arrangement; the bars being inclined at an angle of 45° to the horizon in the direction of their width. The bars of the two sets were thus inclined in opposite directions, and placed so close together that a vertical straight line could not pass between any adjacent pair of them, yet far enough apart to allow all cinders to fall freely through, and the air to pass freely upwards to the fire. The bars were of the same length as the grate, so to extend from front to back. It would be perceived that the effect of this arrangement must be to screen the ash-pit completely from the heat radiated directly downwards from the grate, and so that scarcely any would pass through by reflection. In fact, not a ray of heat could reach the ash-pit from the furnace without suffering four reflections from rough iron surfaces, which would leave a mere shadow of a ray for further progress. Thus, a large quantity of heat which otherwise would be radiated out of the furnace into the ash-pit, thence reflected and so lost, was saved for the boiler. The ash-pit also was only slightly heated by the cinders which fell through: and this source of heat might be reduced to any extent by frequently removing the rubbish from the pit. Another consequence was, that the air passing from below through the grate, not being heated in the ash-pit, entered the fire cold, and therefore not—as it did from ordinary ash-pits—in a rarefied condition. By its coolness, this air prevented to some extent the burning of the grate-bars; and, by its unrarefied state, it produced a more intense and rapid combustion of the fuel after it had passed the bars.



Another part of the contrivance was more especially the smoke-burning apparatus. It consisted of a set of tubes open at both ends passing through the furnace horizontally from front to back, and terminating within the wall of the front of the bridge, with valves to regulate the access of air into the tubes. The fire-bridge differed importantly from that of an ordinary furnace: it was hollow; and was divided into two parts, the larger of which stood up from below: the other, which was shallower, was in contact with the boiler. Between them all the products of combustion passed from the furnace. The two parts communicated with each other by channels at the sides, and thus formed together an annular chamber. The tubes before mentioned entered the front wall of this chamber, and thus established a communication between its interior and the outer air. The back wall or plate, both of the upper and of the lower part of this chamber or bridge, being perforated with numerous holes, opening from the interior of the bridge to the space beyond it, established a direct communication between the outer air and the throat of the flue. There was a second solid bridge beyond the first, descending from the upper side of the flue; this, by interrupting the direct channel through that part of the passage, retarded the flow of the smoke and gases, and caused their perfect mixture with each other within the space between the bridges.

The result of this arrangement was, that a current of highly-heated air which passed through the tubes in the furnace, escaped at the bridge through the perforations in the back wall, and, mixing with the gases from the furnace which held the smoke in suspension, converted the smoke into flame.

It was contended that, by the adaptation of this apparatus to marine boilers, the high temperature of the stoke-holes and boiler-rooms would be obviated, and that the steam vessels would not be so evident from a distance as they now were by the volumes of smoke they gave out; and by having a telescopic sliding funnel, and substituting, during the period of being in action, a horizontal tube with a small fan-blower, any injury to the main funnel would be effectually prevented.

It appeared that the results of this apparatus had been very satisfactory; that at Messrs. Meux's brewery there was not the slightest appearance of opaque smoke from the chimney; and that the money-saving, resulting not only from the more perfect combustion of the fuel, but from the use of an inferior quality of coal at a lower price, amounted to full twenty per cent.

---

November 21st, 1854.

The discussion was renewed on Mr. WOODCOCK'S paper, "*On the means of avoiding smoke from boiler furnaces;*" when it was shewn, that although critically precise experiments for determin-

ing the amount of evaporation had not been previously made, there was no doubt of the fact of its being possible to use a lower-priced fuel, and to do the full amount of work with the boiler, without evolving any opaque smoke from the chimney; and thus, whilst complying with the requirements of the legislature, a pecuniary saving could be effected. Recently, however, by experiments on a cylindrical boiler, 17 feet long by 3 feet diameter, it had been shewn, that  $8\frac{2}{3}$  lbs. of water, injected at  $42^{\circ}$  Fahr., was evaporated by 1 lb. of Newcastle small coal, when Mr. Woodcock's apparatus was in use. It was found, that with small bituminous coal, a better evaporation was maintained than when Llangenoch coal was used, and without any appearance of smoke. The cast-iron bridges of the furnace did not appear to suffer from the effects of the fire,—the passage of the air keeping the metal comparatively cool.

As soon as the valves of the apparatus at Messrs. Meux and Co.'s brewery were closed, there was a dense smoke; but on the instant of opening them, the heated gases combined with the oxygen of the air, and flashed into bright flame. Llangenoch coals had been generally used at Messrs. Meux and Co.'s brewery, not from any economy they offered, as they were not so strong as the Newcastle coals, but for the sake of the neighbourhood, as they did not give out opaque smoke: however, with the apparatus described by Mr. Woodcock, small Newcastle slack could be used; and as it could be purchased at fourteen shillings per ton, whilst the Llangenoch coal cost twenty-eight shillings, there must be a money-saving, and the boilers worked quite as efficiently.

As to the general similitude between the principles advocated by Mr. C. Wye Williams and those brought into notice by Mr. Woodcock, almost the only difference appeared to be, that the former insisted on the necessity for the coldness of the air admitted, whilst the latter contended for the advantage of heating the air prior to its mingling with the gases. On this point, many conflicting opinions were given, and examples quoted. It was, however, allowed, that the arrangement of the Venetian blind screens below the grate bars, was novel, and was likely to be beneficial in preventing radiation into the ash pits, and thence into the boiler rooms of steam vessels; and there would not be any inconvenience from not being able to introduce prickers from beneath the bars, as good stokers always cleared the bars from above, by the use of the T head tool; and none but idle or bad stokers allowed the clinkers to accumulate, so as to run between the bars, and require the use of the pricker.

The use of heated air was practically contended for, because, when the air was admitted at a low temperature, there was a certain amount of loss from the chilling effect of the stream or film of air, before it mingled with the gases; whereas this effect was not perceived when the air was admitted at a certain temperature. Under Mr. Williams' system, this had been attempted to be pro-

vided against by multiplying the number and diminishing the individual area of the apertures for admitting air; but it was argued that, by extending the number of apertures still more, and previously raising the temperature of the entering air behind the bridge, the object would be more certainly attained. The system of supplying air at a very elevated temperature under gas-retorts, had been very advantageously employed for many years, in conjunction with the hollow bridge originally introduced by Mr. Farey, the father of the late Mr. John Farey. (M. Inst. C. E.) In corroboration of these views, it was stated, that on board one of the "Citizen" steam-boats on the Thames, by a free admission of air, only through a series of parallel wire-gauze screens in the fire-door, so as to distribute it in minute jets, the exhibition of opaque smoke had been prevented,—whilst a saving of fuel was effected, without any loss of speed, or any extra labour to the stoker. A hollow bridge was also used; and a blast-pipe being extended from the base of the funnel, and opening into the bridge, further beneficial effect had been produced.

A model was exhibited of a hollow cast-iron bridge-plate, with a series of vertical ribs, so arranged as to form tubes, leading up from the ash-pit to the apex of the bridge; where the air mingled with the heated gases, and passed away in flame. The currents of air up these bridge tubes preserved the iron from destruction, by carrying off the caloric, and it became heated in its upward course.

The introduction of cold air was advocated, on the ground that a mass of air, once broken up into films, or minute jets, would not again unite, but that each particle would pursue its independent course, until it combined with the heated gases. Therefore, the system of admission by the perforated fire-door, so as to pass over the incandescent fuel, had been so strongly advocated.

It was urged, that mechanical or other means should be adopted for regulating the proportion of oxygen, according to the state of incandescence of the fuel on the bars. This, it was contended, was virtually accomplished through the side tubes of Mr. Woodcock's apparatus; as it had been shewn, that the velocity of the passage of air through the tubes, was exactly in proportion with the demand for oxygen by the fuel. That the air was really heated in its passage has been shewn by inserting a thermometer, protected from radiated heat, into a flue in connexion with the hollow bridge.

The question of the applicability of most of the systems of preventing the exhibition of opaque smoke, was shewn to depend, to a great extent, on the area of the fire-grate and the size of the boiler; for if both were restricted, so as to demand an excessively rapid draught, there could not be a sufficient mingling of the gases to insure perfect combustion.

---

INSTITUTION OF MECHANICAL ENGINEERS,  
BIRMINGHAM.

(Continued from p. 385.)

The following paper, by Mr. ARCHIBALD SLATE, was next read :—

*On an Improved Water Filter.*

The subject of water-filters is one which has received much attention, from the advantage of filtering water both for domestic and manufacturing purposes.

The filter that forms the subject of the present paper,—the original invention of Mr. James Forster, of Liverpool,—consists of a small apparatus attached to the cock from which the supply of water is drawn,—the water being passed through the filter at the time of discharge.

The filter consists of a hollow stone cylinder, about 4 inches in diameter, 7 inches long, and  $\frac{3}{4}$ -inch thick, with a round closed end below, and cemented at top into a groove in a cast-iron cap. This cap has a delivery-pipe communicating with the interior of the stone cylinder, and bent to prevent the escape of water, when not required.

The stone cylinder is enclosed in a cylindrical tin casing, which stands on a cast-iron base, into which the supply-pipe and cock are fixed. This cylindrical tin casing is fixed in a groove in the cap and base; and by means of a frame, connected by two side pins to the base, and carrying a binding-screw, which presses upon the centre of the cap, the joints are made water-tight.

When the supply-cock is opened, the water fills the outer casing, filters through the stone cylinder, and is discharged by the delivery pipe. The stone being a fine-grained pure sandstone, retains all the impurities of the water upon the outer surface, and delivers the water in a pure clear stream. The action of the filter is an imitation of a pure spring issuing from a sandstone rock, which may be considered as a natural pressure filter.

There is an important advantage in filtering water immediately before using it, as its freshness is then insured; but this is liable to be impaired, if the water is filtered previously, and stored up until drawn off for use. With the use of such a filter, whatever may be the state of the water in the mains, from the opening of them for repairs, and other causes, a supply of pure water is always obtainable.

The practical value of a filter is greatly influenced by the facility with which it can be kept clean: and in the present filter, this object has been more particularly aimed at. The process of cleaning it is very simple, and can be effected by any person in a few minutes. The binding-screw is loosened, and the frame turned on one side, which allows the iron cap, with the stone cylinder at-

tached, to be lifted out of the casing. The outer surface of the stone may then be scrubbed with a piece of sandstone, and well washed; which removes all the deposit, and leaves it as clean as at first. The deposit from impurities from the water is found to take place entirely on the outer surface of the stone, and penetrates only a very slight depth into the stone; so that it can be readily and completely cleaned by scrubbing the surface with sandstone. When the water to be filtered is very dirty, the stone cylinder is encased in a flannel bag, which prevents the larger portion of the deposit from lodging on the stone. In cases where the water is somewhat infected, by being exposed to any decaying organic matter, some animal charcoal is placed in a bag, or a flat perforated box, in the bottom of the filter, to purify the water before entering the filtering stone.

These filters have been in use for the last three years, and have proved quite satisfactory under all circumstances. They are applicable for general domestic use, as the pressure required for filtering is so small, that any house having water laid on from water-works, or even a rain-water cistern at a moderate height, would have sufficient pressure for working this filter: it is working at Lambeth, with a pressure of only 9 feet, and at the Board of Health, under about 15 feet head. The small size of the filter, and its convenience of application, make it suitable for any situation. It appears also, from experiment, that in the cases where the water is soft, and has become impregnated with carbonate of lead, from contact with leaden pipes or cisterns, this is entirely separated by the stone filter—an important sanitary advantage.

---

The Chairman remarked that he had brought the present plan before the meeting in consequence of the subject of water-filters having been referred to in the discussion at the last meeting; and this was brought forward as a simple construction of filter which could be readily and frequently cleaned, so as to preserve it always in good action.

Mr. Forster exhibited a specimen of the filter, and shewed the process of cleaning it when required; and, in answer to a question as to how many gallons of water could be passed through it before the stone required taking out and cleaning, he replied,—that he had not had an opportunity of ascertaining the quantity of water, but could state that one of the filters fixed in Liverpool had supplied all the water for a large household, during three months, before requiring cleaning. The time of cleaning would, of course, depend on the quality of the water; but, as far as his experience went, the filters for domestic purposes would not require cleaning oftener than every two or three months with the ordinary quality of water.

A member observed,—there was no difficulty in obtaining a good filtering medium; but the difficulty was to get a filter that

would keep at work without requiring renewing or cleaning so frequently as to limit greatly its practical application. He had tried a great many experiments on the subject, with a variety of materials, and found this was the principal difficulty. He had tried sandstone as a filter, in a disc of 9 inches diameter, and  $\frac{1}{4}$ -inch thick, but found it was nearly stopped by the accumulation of deposit in about 12 hours, when about 400 gallons had passed through: and, unless the sandstone were much purer and less calcareous than could be procured in this district, he did not understand how it could be kept at work any length of time. He thought the most important practical test of a filter was the quantity of water that it would filter before requiring cleaning or renewing, as well as the convenience of effecting the cleaning.

Another member thought a filter that did become choked would be preferable, as that was a proof it was doing its duty.

Mr. Forster said he had endeavoured to get a measure of the quantity passed through, but had not been able to do so, from the long time that the filter kept at work before requiring cleaning.

The Chairman observed that it appeared to him the more important point was to have a filter that could be very readily taken to pieces, cleaned, and put to work again, rather than one which would continue a long time before requiring to be cleaned. He hoped that the quantity of water which the filter passed before it required cleaning would be ascertained and communicated at a future meeting.

---

July 26th, 1854.

After the usual preliminary business of the meeting had been gone through, the following paper, by Mr. EDWARD A. COWPER, of London, was read,—the President (W. FAIRBAIRN, Esq.) occupying the Chair:—

*“Description of the wrought-iron roof over the central railway station at Birmingham.”*

This roof, which covers the New Street Station, recently opened in Birmingham, is in one span, without intermediate supports,—being considerably larger than any roof previously constructed; and, on this account, the present description of the construction is laid before the Institution, as a record, by the author, by whom the original drawings and calculations were made for the contractors, Messrs. Fox, Henderson, and Co.

Under the roof are 10 parallel lines of railway, with 4 platforms, and a carriage road, extending the whole length of the roof, for the accommodation of the traffic of three railways, with trains to and from six different directions (London, Liverpool, Derby, Bristol, Dudley, and Walsall), and having 170 trains arriving or departing daily.

The whole length of the roof is 864 feet, and it is constructed of 36 principals fixed at 24 feet distance from each other.

The span of the principals varies from 211 feet to 191 feet. The ground being irregular in plan, and the space valuable, the outline of the roof was made to follow its boundary, and the roof is constructed tapering in two different proportions. The lengths of the several principals are consequently all different,—the greatest span being 211 feet at one end of the roof, and the span diminishing to 191 feet at the other end.

All the principals are similar,—each successive one, from the largest, being reduced proportionately in the length of every part, so that the lines in each portion converge to one point; and, in consequence, the effect of the irregularity in outline is not perceptible under the roof, and is only observed on examining the outside, at the back.

The roof is supported on one side upon brick pilasters, projecting from the wall of the office buildings, and on the other side upon hollow cast-iron columns, 2 feet in diameter, and weighing  $5\frac{1}{2}$  tons each, which are connected together by cast-iron arched girders. The height of the springing of the principals is 33 feet above the level of the railway: the rise of the tie-rod, which forms a curve, is 17 feet in the centre of the largest principal, and the depth of the curved principal is 23 feet, making the rise of the main rib 40 feet; and the total height is 84 feet to the top of the louvre in the centre of the roof.

The main rib of each principal consists of a vertical plate of wrought-iron, 15 inches deep, and  $\frac{1}{4}$ ths of an inch thick, with two angle-irons 6 by 3 inches, rivetted upon each edge—forming a flange at top and bottom  $12\frac{3}{4}$  inches wide. The junctions of the angle-irons are made to break joint with one another; and junction-plates are rivetted on each side of the vertical rib, at the joinings.

The tie-rod is 4 inches diameter, enlarged at the ends where screwed, so as to preserve the full sectional area at the bottom of the thread. The several portions of the tie-rod are joined at the foot of each strut by a wrought-iron coupling-box, with a right and left-handed screw.

There are in each principal 12 vertical struts, each constructed of four angle-irons, set diagonally in the four angles of a square, and separated by a series of small cast-iron crosses, secured by bolts passing through the hollow arms of the cross. These struts are enlarged in the middle, to give the requisite strength, by proportioning the length of the crosses, so as to give a curved outline. Each end of the strut is secured to a cast-iron shoe,—the upper one being bolted to the bottom flange of the main rib, and the lower one clipping the coupling-box of the tie-rod. The diagonals in the principals are of flat iron,  $\frac{3}{8}$ -inch thick, and from 3 to 5 inches wide: they are rivetted together where they cross, and attached at each end by bolts to lugs upon the cast-iron shoes.

The foot of each principal, on the wall side, has a cast-iron

bed-plate rivetted on the under side, which is recessed into a stone built into the top of the pilaster; and the foot of the principal, at the column, has a flat wrought-iron bed-plate, resting upon four wrought-iron rollers, 2 inches diameter and 19 inches long, which work upon a corresponding cast-iron plate, fixed on the top of the column, to allow for the expansion and contraction of the principal from variation in temperature.

The purlins are fixed at 10 feet intervals, and consist each of a wood batten, 6 inches square, trussed with a  $\frac{3}{4}$ -inch iron rod. The cast-iron shoe at each end clips the back of the principal, and it is bolted to it; serving as an abutment for the two adjoining purlins.

A large louvre, for ventilation, 5 feet in height at the sides, is fixed along the whole length of the ridge of the roof. Diagonal wind-ties,  $1\frac{1}{2}$  inch diameter, extend over the whole roof,—starting from the foot of every alternate principal, and bolted to the main ribs at each intersection.

One half of each side of the roof is glazed, and also the louvre in the centre, amounting to  $\frac{2}{3}$ ths of the surface; the rest is covered with galvanized corrugated iron, of the thickness of No. 18 wire gauge, which is nailed down upon wood purlins. The glass is rough-rolled fluted plate, from Messrs. Chance's works,  $\frac{3}{8}$ ths of an inch thick, or 44 oz. per foot,—each plate being 6 feet long by 16 inches wide. The total area of glass is 94,000 square feet, weighing about 115 tons. The whole area of the roof is 175,000 square feet, or rather more than 4 acres.

The skylight is constructed in three portions on each side of the roof,—each one being a plane about 17 feet wide, and the whole length of the roof, and at a less slope than the adjoining portion below,—the least slope being 3 to 1. The corrugated iron between the skylight and the louvre is blocked up from the curved back of the principals at the upper portion, so as to form a uniform slope of 5 to 1.

Each end of the roof is closed by a glazed screen down to the horizontal line of the springing. The erection of the roof was completed in May, 1854.

---

Mr. Cowper exhibited a number of large drawings, shewing the construction of the roof, and explained, by a table, the mode of calculating the series of dimensions required for the several parts, from the variation in size of the different principals. One principal was drawn out complete of the largest size, and one of the smallest size, in each of the two portions of the roof where the taper was regular; and then the dimensions of all the several parts were entered in the columns of a table,—the largest principal being at the top of the table, and the smallest at the bottom. The dimensions of all the intermediate principals were entered successively, by taking the difference between the largest and smallest dimensions in each column, and dividing this difference



by the number of intermediate bays, making the dimensions of each one an arithmetical mean between those on each side of it. The first 11 principals diminished in span  $1\frac{1}{2}$  inches each, and the rest  $8\frac{1}{2}$  inches each. By this plan there was a considerable saving of time, as well as less risk of inaccuracy, than in drawing out and calculating each one of the principals separately. The dimensions were taken to  $\frac{1}{8}$  inch in each case for the actual construction, which was found to be as accurate as was useful for the purpose. The number of different dimensions required for making each principal was about 60; and as there were 36 different principals, a total number of dimensions of upwards of 2000 was requisite for the lengths of the different portions alone.

The Chairman observed, that the description of such a roof formed a very interesting and valuable record,—the span of 211 feet being the largest, by a considerable amount, that had ever been erected. The roof of the Railway Station at Liverpool, of 154 feet span, was the largest span he was acquainted with previously; and at the time that was in construction he remembered being engaged, together with Mr. Locke, in a number of experiments for the purpose of fully testing the strength of the roof at Messrs. Turner's, at Dublin, where it was made. A portion of the roof was erected temporarily, and it was tested by suspending weights from it, amounting to a load of 40 lbs. upon every square foot of the external surface of the roof, including the weight of the materials and covering of the roof. The principals were found to stand this test satisfactorily, though it was considered a very severe one, and considerably greater strain than the roof would be ever likely to be subjected to when completed. He inquired whether the Birmingham Station roof had been similarly tested, and what were the results?

Mr. Cowper shewed a diagram of the results of testing the principals, which had been effected by erecting three of them upon the ground, and loading the centre one with weights suspended from the bottom of each of the struts: the other two principals serving to hold the centre one vertical, without assisting to support the load. A weight of 45 tons was first applied, distributed uniformly along the whole length, which amounted to a load of 20 lbs. per square foot upon the roof, independent of the weight of the roof itself; and the deflection with this was  $1\frac{1}{2}$  inches in the centre in the whole span of 211 feet. A load of 67 tons, distributed, amounting to 30 lbs. per square foot, made a deflection of  $2\frac{5}{8}$  inches; and the extreme load of 90 tons, or 40 lbs. per square foot, in addition to the weight of the principal, amounting to about 25 tons more, gave a total deflection of  $3\frac{3}{8}$  inches. The total load, in this case, including the principal, was 115 tons, amounting to more than 50 lbs. per square foot; but it was found, when the weight was removed, after having been left on some hours, that no perceptible set had taken place, and the principal recovered its original form. This un-

usual result was caused probably by the circumstance that the weight of the principal itself, 25 tons, was sufficient to take up all the slack in the several joints, and bring all the parts to a full bearing. The sections of metal in the different parts were proportioned equally to the respective strains; so that the strain per square inch upon the material was nowhere sufficient to produce permanent extension or compression, with the amount of load applied,—the total strain, including the covering, not exceeding  $8\frac{1}{2}$  tons per sectional inch on the parts in tension, and 4 tons per sectional inch on the parts in compression.

Another test that was applied to the principal, perhaps even more severe than the maximum distributed load, was a load of 45 tons on the north side, with only 11 tons on the south side. The greatest deflection was then 3 inches at about one-fourth the length on north side of the centre, and  $2\frac{1}{2}$  inches deflection at a corresponding distance on the south side. A load of 22 tons was then placed on the south side, with the same load as before (45 tons) on the north side. The deflections were, in that case, 3 inches and  $2\frac{1}{2}$  inches respectively, at the same points as before. The remarkably small extent of distortion in the principal, under this very severe test, shewed satisfactorily its rigidity and stiffness to resist irregular oblique strains; an unbalanced excess of load on one side, amounting to 34 tons, having caused a distortion of only  $\frac{1}{2}$  inch above and below a uniform curve of deflection. The total extension in the length of the principal on the base was  $2\frac{3}{8}$  inches with the greatest weight.

---

The following paper, by Mr. SAMUEL H. BLACKWELL, of Dudley, was next read:—

*On Kind's improved system of boring.*

There are few processes of greater importance in a mining country, and especially in one in which mining operations have been carried on for long periods, than that of boring.

In all mining districts the operations are, of course, at first principally confined to the mineral formations, whether beds or veins, which lie near the surface, and thus disclose themselves readily to view. But as these formations are followed deeper and deeper, and surface indications no longer act as guides, or only partially so, it becomes of the greatest importance that some easy and economical method should be employed, for the purpose of ascertaining whether minerals exist at points where no actual proofs of such have been given.

The extent to which our known mineral fields are now being worked, and the dependence of the continued prosperity of the country upon the further development of our mineral resources, make it of the greatest importance to avail ourselves of every improvement in the cost and dispatch of any processes having for their object the discovery of new mineral fields.

The principal means of effecting such new discoveries is that of boring; but the defect of the present processes often leads to the risk of expensive sinkings, being preferred to the delay and uncertainty of boring, under circumstances in which, if economy, dispatch, and certainty could be insured, boring would be invariably adopted.

These defects arise from the permanent attachment of the boring chisel to the rods which are employed to lift and lower it: the blow is thus given not simply by the chisel itself, but by the entire length of rods and the chisel, forming together one single tool.

When great depths are attained, the jar and vibration communicated to the rods, through their entire length, by their fall, and the percussion of the chisel, are so great as to require corresponding strength and weight of material. The space through which the rods are allowed to fall, must, under these circumstances, necessarily be small, as no strength of material would long withstand the constant jar and vibration consequent upon a fall through any great space, and thus, in practice, a fall of a few inches only is all that is obtained. The strength and weight of the rods are also limited by hand-power being generally employed. The chisel used is thus always small, and the bore-hole correspondingly small; giving rise to much friction against the sides, and rendering the indications of the measures passed through uncertain, from their being ground up, more or less, by the action of the chisel.

Kind's improved system of boring—the subject of the present paper—remedies all these defects. The tool is free, and is attached to the rods simply whilst being lifted: the lifting can be effected to any height required, and, when so lifted, the tool is detached from the rods, and falls freely by itself. It is then followed by the rods, which pick it up, and lift it again, for another fall. The rods may thus be made light, and the tool heavy; no vibration or jar being communicated to the rods by the percussion of the fall. Large bore-holes may thus be made, and cores of 6 to 10 inches in diameter taken out, so as to shew the precise character of the beds passed through, and their exact kind of stratification. The attachment of the tool to the lowering rods is effected by a pair of clips, which are actuated by a sliding wedge. These clips grip the head of the tool when they are raised, and at the same time lift the tool; but when the movement is reversed, they will open and let the tool fall. The wedge is operated by being connected to a disc or piston, carried by, and capable of sliding on, the lowering rod; which sliding motion is effected by the action of water in the bore-hole, pressing on the piston, either on its upper or lower surface.

If the tool be resting on the bottom of the bore-hole, detached from the rods, as the rods descend to pick it up, the pressure of the water upon the piston is on its under surface, and consequently the wedge will be raised, and the clips kept open. When the rods come completely down, the open clips descend over the

head of the tool, and, on being quickly lifted, the pressure is reversed: the wedge is thereby pressed down, and the clips are closed upon the tool to carry it upwards. When it has been lifted as high as may be required, the motion of the lifting-rods is reversed, and the pressure is once more thrown upon the under surface of the piston.

Chisels of any required form may be screwed into the tool; either to cut away the whole material of the bore-hole, or to leave a solid central core.

When these solid cores are required, they are extracted, first, by using a crown borer, which, being armed with five or more chisels, makes, by percussion, a circular cut to the required depth. This crown borer is then removed, and a second tool, having a ring of clicks, inclining inwards, is lowered to the bottom of the core thus formed,—the clicks sliding down the surface of the core. An interior cylinder, previously suspended by a cord, is then lowered, so as to press the clicks inwards; a few short strokes are given to the rods, by which the clicks groove themselves into the core, and then, by a sudden jerk, the core is detached and brought carefully to the surface.

Mr. Blackwell exhibited two specimens of the solid cores that had been cut out and raised by the apparatus;—one cylindrical piece of salt rock,  $5\frac{1}{2}$  inches diameter and 12 inches long, from the Montmoret Salt Mines, in the south of France, at about 200 yards depth, broken off square at the ends: the other specimen was hard shale rock, from the coal measures,  $7\frac{1}{2}$  inches in diameter and 12 inches in length, with the ends sloped off at an angle of about  $45^\circ$ .

The Chairman remarked that the specimens were very regular in form, and shewed great perfection in the action of the tools. It appeared an excellent plan for examining strata, and must prove an important advantage in preventing useless outlay in sinking shafts, by the information afforded of the actual dip as well as formation of the strata.

Mr. Mc Connell thought the operation was very complete in bringing up such large and regular specimens; and the means of measuring the dip of the strata would be very serviceable if accuracy could be relied on, and the expense of the apparatus was not too great. He inquired what was the cost of the whole apparatus?

Mr. Blackwell said he was not able to state the actual cost; but the expense of boring was less with this than the ordinary plan, although a larger bore-hole was obtained. Instead of the strong wrought-iron rods required in the ordinary plan, when boring to a great depth, on account of the great strain and jar on the rods when they fell all together with the chisel, there were only 3-inch wood rods used in the new plan, as they were subjected to no strain besides the lifting.

PROVISIONAL PROTECTIONS GRANTED.

*[Cases in which a full Specification has been deposited.]*

2312. James Cooper Hall, of Monkwearmouth, Durham, for an improved windlass.—*[Dated October 31st.]*  
 2319. George Taylor, of Holbeck, near Leeds, for certain improvements in mills for grinding corn and other substances.—*[Dated November 1st.]*  
 2443. George Tomlinson Bousfield, of Sussex-place, Loughborough-road, Brixton, for improvements in the manufacture of wrought-iron carriage and other wheels, and pulleys,—being a communication.  
 2444. William Coulson, of Fetter-lane, York, for improvements in machinery for morticing, tenoning, and boring.

*The above bear date November 17th.*

*[Cases in which a Provisional Specification has been deposited.]*

1815. Frederick Crace Calvert, of Manchester, for improvements in the treatment of heating, puddling, and refining iron slags, or cinders.—*[Dated August 18th.]*  
 1839. Thomas Lees, of Stockport, for certain improvements in the mode of lubricating parts of steam-engines and of apparatus attached to steam-boilers; and in the method of preparing and adapting certain substances for that purpose.—*[Dated August 22nd.]*  
 1899. Louis Pierre Lehugeur and Michel Uttinger, both of St. Denis, near Paris, for improvements applicable to machinery for printing fabrics.—*[Dated August 30th.]*  
 1927. James Parker, of Birmingham, for an improvement or improvements in the smoke boxes of locomotive engines.  
 1936. Jacques François Henry Hypolite Hervé de Lavaur, of Paris, for certain improvements in securing waterproof wrappers or coverings used in packing goods.

*The above bear date September 4th.*

1959. Samuel Frearson, of Glascote, Warwickshire, for improvements in the construction and manufacture of buttons; a part or parts of which improvements may also be applied to other similar purposes,—being a communication.  
 1960. Tony Petitjean, of Upper John-street, Fitzroy-square, for an improved process for re-cutting or re-forming the faces of files.

*The above bear date September 8th.*

1984. Richard Laming, of Carlton Villas, Maida Vale, for improvements in purifying gas from ammonia and other impurities, and preparing pure gas for burning; in obtaining ammonia and certain salts of ammonia and soda, and in treating certain salts of ammonia.—*[Dated September 12th.]*

2024. Alfred Tylor, of Warwick-lane, London, and Henry George Frasi, of Herbert-street, New North-road, for improvements in water-closets.—[*Dated September 20th.*]
2072. Thomas Griffiths, of Madeley, Shropshire, for an improved pump for raising and forcing water.—[*Dated September 26th.*]
2097. William Wilkinson, of Nottingham, for improvements in looped, pile, and cut pile fabrics, and in machinery for brushing or raising a cut pile or fleece upon the web on both sides the article, or on one side only; by which means he secures a looped web not liable to let down.
2099. William Tucker, of Old Brompton, for preventing the escape of fuliginous smoke from shafts and flues.
2101. Thomas Collins, of Gayton, Northamptonshire, for improvements in manufacturing bricks and tiles.
2103. Moses Poole, of the Avenue-road, for improvements in condensers,—being a communication.

*The above bear date September 30th.*

2105. Auguste Edouard Loradoux Bellford, of Castle-street, for improvements in suspended purchases,—being a communication.
2107. George Wall, of Manchester, for improvements in the manufacture of railway tickets, and other similar articles, from a substance or material capable of being re-used.
2109. Thomas Sherriff, of Glasgow, for improvements in moulding or shaping metals.
2111. François Durand, of Paris, for certain improvements in looms for weaving.
2113. Nicholas Bennett, of Furnival's-inn, for a substitute for the scaffolding at present employed in and for the erecting and repairing of buildings,—being a communication.
2115. Christopher Hill, of Chippenham, Wilts, for improvements in the manufacture of pulp.

*The above bear date October 2nd.*

2117. James Hammond, of Brunswick-street, Stamford-street, for holding a book in such a position that it may be read with ease and comfort in an erect, reclining, or completely recumbent position,—to be called "Hammond's suspension reading desk."
- 2118.—William Tatham, of Rochdale, for improvements in machinery or apparatus for preparing, spinning, doubling, twisting, and winding cotton, wool, flax, silk, and other fibrous substances.
2119. William Blythe, of Oswaldtwistle, Lancashire, and Emile Kopp, of Accrington, for improvements in the manufacture of soda ash and sulphuric acid.
2121. Alfred Vincent Newton, of the Office for Patents, 66, Chancery-lane, for improvements in motive power engines, applicable to the working of their valves, and to the conversion of the reciprocating motion of such engines into rotary motion,—being a communication.

2123. William Mc Naught, of Rochdale, for improvements in slide-valves for steam-engines.

2125. Wright Townend, of Harden Bingley, Yorkshire, for an improvement in combing wool and other fibres.

*The above bear date October 3rd.*

2127. John Kershaw, of Stockport, for certain improvements in self-acting mules.

2128. Frederick Samson Thomas, of Cornhill, London, for improvements in locomotives.

2129. Frederick Samson Thomas, of Cornhill, for an improved mode of obtaining motive power.

2130. David Chalmers, of Manchester, for improvements in the mode or method of working railway breaks, and communicating signals.

2131. William Peel Gaulton, of Crag Works, near Macclesfield, for improvements in brakes, applicable to railway carriages and other vehicles.

2132. John Disher, of Edinburgh, for improvements in mashing apparatus for brewing.

2133. Aimé Antoine Joseph Legentil, of Arras, France, for certain improvements in pumps or machinery for raising and forcing water and other fluids.

2134. Thomas Crossley, of Scott's-yard, London, for an improved mode of manufacturing printing blocks,—being a communication.

2135. Thomas Prosser, of New York, for improvements in the manufacture of certain hollow closed vessels, and in the machinery or apparatus employed therein; parts of which improvements are also applicable when preparing for and fastening tubes into steam-boilers, or other vessels requiring tubes to be fixed therein.

2136. William Henry Phillips, of Camberwell New-road, for improvements in rotatory steam-engines.

2137. Thomas Webster Rammell, of Trafalgar-square, for improvements in steam-boiler and other furnaces.

2138. John Perry, of Hunslet Old Mill, near Leeds, for improvements in preparing wool for combing.

*The above bear date October 4th.*

2139. Thomas Edwin Moore, of Great Titchfield-street, St. Mary-le-bone, for certain improvements in machinery or apparatus for curvilinear and annular cuttings in metals and other hard substances.

2140. William Bridges Adams, of Adam-street, Adelphi, for improvements in rails for railways, and in the connections and fastenings for rails.

2141. Enoch Oldfield Tindall, of Scarborough, for improvements in mangles and wringing-machines for smoothing and wringing clothes and woven fabrics.

2142. Thomas Harris, of Nantyglo, for separating the steam from the condensed water and mud in its transit from the boiler to the cylinder of a steam-engine, stationary or locomotive.
2143. George Collier, of Halifax, for improvements in the manufacture of carpets and other terry fabrics.
2144. William Frost, of Wine-Office-court, Fleet-street, for improvements in steam-engines.
2145. Thomas Bennett, of Woodbridge-street, Clerkenwell, for improvements in the apparatus employed in the manufacture of gold, silver, and metal leaf.
2146. John Adams Lander, of Southwark-bridge-road, for improvements in machines employed in and for the manufacture of spikes and nails.
2147. John Macmillan Dunlop, of Manchester, for improvements in machinery or apparatus for preparing, spinning, and doubling cotton and other fibrous materials.
2148. François Durand, of Paris, for certain improvements in circular looms.

*The above bear date October 5th.*

2150. John Britten, of Birmingham, for a new or improved machine for sweeping or cleaning chimnies.
2151. Peter Kerr, of Paisley, for improvements in the treatment and finishing of threads or yarns.

*The above bear date October 6th.*

2152. William Chambers, of Hampson Mill, near Bury, Lancashire, for improvements in machinery for beetling cotton and other fabrics.
2153. Charles Blunt, of Sydenham, and Joseph John William Watson, of Wandsworth, for improvements in machinery for the production of artificial fuel.
2154. Robert Way Uren, of Foggington, Devonshire, for improvements in machinery for the manufacture of bricks and tiles.
2155. George Thomas Selby, of Smethwick, for an improvement in furnaces.
2156. Jean Baptiste Seraphin de Méritens, of Paris, for certain improvements in the mode of dyeing cotton, flax, and other fibrous substances, and fabrics generally.
2157. Thomas Roberts and John Dale, both of Manchester, for improvements in obtaining and treating extracts from certain dye-woods, and in apparatus for obtaining such extracts.
2158. William Johnson, of Lincoln's-inn-fields, for improvements in windlasses,—being a communication.
2159. Robert Maynard, of Whittlesford, Cambridge, for improvements in machinery for threshing and dressing grain.

*The above bear date October 7th.*

2160. James Aikman, of Paisley, for a roller for scouring and finishing textile fabrics.



2161. James Shanks, of St. Helen's, for an improved mode of manufacturing sulphuric acid,—being a communication.

*The above bear date October 9th.*

2162. William Crosskill, of Beverley, Yorkshire, for improvements in the construction of portable railways.
2163. Noel Prothéry, of Lyons, for improvements in machinery for making lace.
2164. Henry Thomas White, of Queen's-terrace, Hammersmith, and George Roberts, of Great Peter-street, Westminster, for an improved mode for rendering hats, caps, and other coverings for the head self-ventilating.
2165. Valentine William Hammerich, of Altona, Holstein, for an improved construction of buoyant mattress.
2167. Joseph Burdekin Jackson, of Etna Works, Sheffield, and William Bowler, also of Sheffield, for improvements in furnaces or fire-places, and in the prevention of smoke.
2169. John Kershaw, of Brixton, for improvements in the manufacture of wrought-iron railway wheels.
2170. Henry Crosley, of Camberwell-grove, for improvements in the manufacture of waddings for cannon and fire-arms.
2171. William Chubb, of Clifton, for improvements in the construction of beams and parts of ships, ships' masts and spars, and other like structures.
2172. Marie Amédée Charles Mellier, of Paris, for improvements in the manufacture of paper.

*The above bear date October 10th.*

2175. William Henry Tayler, of South-row, New-road, St. Pancras, for improvements in cartouch belts or cases for containing cartridges, to be worn round the waist, or otherwise; calculated for arms of every description, guns, pistols, and other fire-arms.
2176. Samuel Rogerson and James Rogerson, both of Manchester, for improvements in the production of ornamental patterns upon velvet and other woven fabrics, and in machinery or apparatus for effecting the same.
2177. Robert Cruise, of Manchester, for improvements in machinery or apparatus for stopping railway carriages.
2178. John Jackson, of Belfast, for improvements in treating or preparing tow, so as to render it fit for drawing or roving.
2179. Thomas Shaw, and Richard Dixon, both of Preston, Lancashire, for improvements in slubbing, roving, and jack frames, employed in the preparation of cotton and other fibrous substances.

*The above bear date October 11th.*

2180. Edward John Seville, of Brixton, for an improvement in the manufacture of hats,—being a communication.
2181. William White, of York Villa, Kensington Park, Bayswater, for improvements in the manufacture of manures.

2182. James Timmins Chance, of Birmingham, for improvements in manufacturing articles from the minerals or rocks, of the descriptions commonly called basalt or trap, sometimes rowley-rag and whinstone.
2183. Ancel Alexander Routledge, of Neath, Glamorganshire, for improvements in the manufacture of detonating railway signals.
2184. Joseph Hood, of Newmilns, Ayr, N.B. for improvements in ornamental weaving.
2185. Alexander Parker, of New Milns, Ayrshire, N. B., for improvements in ornamental weaving.
2186. François Alexandre Nicolas Delsarte, of Paris, for a new mode of, and apparatus for, tuning pianos and other kinds of stringed instruments.

*The above bear date October 12th.*

2188. James Lamb Hancock, of Milford Haven, for an improved machine for ploughing or working land.
2189. Sir James Caleb Anderson, of Fermoy, Cork, Ireland, for improvements in locomotive engines.
2190. Arthur Dobson, of Belfast, for certain improvements in looms for weaving.
2191. Charles Frederick Stansbury, of Cornhill, for improved apparatus for heating buildings,—being a communication.
2192. George Weeks, of Dorset-street, Portman-square, and George Pinner, of Globe-road, Mile End, for improvements in the construction of furnaces.
2193. William James Barsham, of Stratford, Essex, for improvements in machinery or apparatus for crushing mineral and other substances.

*The above bear date October 13th.*

2195. John Harrison, of Brighouse, Yorkshire, for improvements in the bosses applied to mill-stones.
2197. John Coope Haddan, of Chelsea, for improvements in the manufacture of cannon, and of projectiles for the same.
2198. Søren Hjorth, of Copenhagen, for an improved magneto-electric battery.
2199. Søren Hjorth, of Copenhagen, for an improved electro-magnetic machine.
2200. Christopher Holt, of the New-road, St. Pancras, for improvements in fastenings for the laths of iron bedsteads, couches, and other similar articles of furniture.
2201. Robert Pinkney, of Long-acre, for improvements in bottles, jars, and other like vessels, and in the method of stoppering them.
2203. Louisa Monzani, of Greyhound-place, Old Kent-road, widow and administratrix of Willoughby Theobald Monzani, late of St. James's-terrace, Bermondsey, deceased, for an improvement in brushes and brooms. [This is the same invention as that

for which letters patent were granted to her said late husband, on the 20th June, 1854.

2204. James Hadden Young, of College-street, Camden Town, for improvements in brooms or brushing apparatus.  
 2205. John Henry Pape, of Paris, for improvements in the manufacture of boots and shoes.  
 2206. William John Biaseker, of Birmingham, for a new and improved and durable method of labelling bottles and such like vessels or articles as require or may require labelling.

*The above bear date October 14th.*

2207. Thomas Edwin Moore, of Great Titchfield-street, for improvements in apparatus for sharpening knives, scissors, and other similar edged tools.  
 2208. John Bonnell, of Spittlegate, Grantham, for improvements in apparatus for holding oil for lubricating purposes.  
 2209. Nathan Thompson, jun., of New York, for improvements in life-preserving seats.  
 2210. Etienne Bernot, of Paris, for a new machine for cutting files, which he calls "Bernot's file-cutting machine."  
 2211. William Rossiter, of Goswell-road, and Matthew Edwin Bishop, of Cannon-street West, for improvements in the manufacture of pulp, suitable for paper, pasteboard, and millboard, papier-maché, and other like purposes.  
 2212. John Henry Johnson, of Lincoln's-inn-fields, for an improved apparatus for discovering the leakage or escape of gas, —being a communication.  
 2213. William Wain, of Brunswick-street, Stamford-street, for improvements in the construction of screw-propellers.  
 2214. Lionel John Wetherell, of Compton-street, Clerkenwell, and Augustus Johann Hoffstaedt, of Albion-place, Surrey, for an improved construction of pump.

*The above bear date October 16th.*

2215. William Henry Child, of Providence-row, Finsbury, for certain improvements in the manufacture and construction of brushes.  
 2217. John Coghlan, of Craven-street, Strand, for an improved mode of signalling on railways by electric telegraph.  
 2218. Louis Cornides, of Trafalgar-square, for an improved apparatus for amalgamating the gold and silver contained in pulverized ores.  
 2219. John Lawes Cole, of Henry-street, Salmon's-lane, Limehouse, for an improved construction of portable drill.  
 2220. Arthur Veal, of Oxford, for improvements in the manufacture of boots.  
 2221. Alfred Illingworth and Henry Illingworth, both of Bradford, Yorkshire, for improvements in machinery or apparatus for combing wool and other fibrous substances.

2222. Jacob Dockray, of Leeds, and John Dawson, of Holbeck, Leeds, for certain improvements in machinery for raising woolen cloth.
2224. Richard Green, of Sydney-street, Brompton, for improvements in propelling vessels.

*The above bear date October 17th.*

2226. Auguste Edouard Loradoux Bellford, of Castle-street, for certain improvements in breech-loading fire-arms,—being a communication.
2227. Peter Armand le Comte de Fontainemoreau, of South-street, for improvements in preventing collisions on railways,—being a communication.
2228. Ernst Gessner, of Aue, near Schneeberg, Saxony, for improvements in gig-mills.
2229. George Hamilton, of Great Tower-street, for improvements in obtaining soundings.
2230. John Mason, and William Robertson, both of Rochdale, for improvements in machinery or apparatus for preparing and spinning cotton and other fibrous substances; part of which improvements is also applicable for shifting straps by which motion is communicated in other machines.
2231. Benjamin Franklin Cooke, of Boston, U. S., for an improved mode of caulking ships,—applicable also to the rendering of roofs waterproof.
2232. Mark Wheeler, of Newton-street, Holborn, for an improved mode of consuming smoke arising from the combustion of fuel in furnaces.
2233. Howard Ashton Holden, of Birmingham, for certain improvements in roof lamps for railway or other carriages, and for parts used in connection with the same.

*The above bear date October 18th.*

2234. Robert Walter Winfield, of Birmingham, for an improvement or improvements in tubes and rods used in the construction of articles of metallic furniture.
2235. Benjamin Nicoll, of Regent-circus, for improvements in shirt-fronts.
2237. Peter Armand le Comte de Fontainemoreau, of South-street, for improvements in the construction of grates,—being a communication.
2238. John Platt, of Oldham, for improvements in machinery or apparatus for making bricks.
2239. Thomas Biggart and Allan Loudon, both of Dalry, Ayrshire, N.B., for improvements in regulating motive power engines.
2240. Thomas Higgins, of Liverpool, for improved apparatus applicable to the ventilation of ships and mines and other useful purposes.

*The above bear date October 19th.*

2241. William Marsh, of Bywater-street, King's-road, Chelsea, for an improved rocking and lounging chair.
2242. Louis Auguste Chenu and François Frederic Pillias, of Fontainebleau, France, for certain improvements in preserving animal substances.
2243. Thomas Allan, of Adelphi-terrace, Westminster, for improvements in applying electricity.

*The above bear date October 20th.*

2244. Julian Bernard, of Club-chambers, Regent-street, for improvements in machinery or apparatus for stitching.
2245. Julius Smith, of Gainford-place, Barnsbury-road, and Frank Sandom Thomas, of South-terrace, Walworth, for an improved apparatus for steering ships and other vessels.
2246. William Joseph Smith, of Stretford, Lancashire, for a certain improvement in buttons.
2247. William Alexander Edwards, of Brooke-street, West-square, Lambeth, for separating iron or steel from brass, gun-metal, and all other metallic filings.
2248. John Jamieson, of Oldham, for certain improvements in steam-engines.
2249. Abraham Gerard Brade, of Paris, for improvements in the manufacture of gas-fittings,—being a communication.
2250. Bennett Johns Heywood, of Green Mount Cottage, Dalkey, near Dublin, for improved apparatus for affixing postage and other stamps to envelopes, letters, and other documents.
2251. William Green, of Howard-buildings, Brick-lane, and Joseph Pickett, of Duke-street, for improvements in treating or ornamenting textile materials or fabrics and paper, and in machinery or apparatus for effecting the same.

*The above bear date October 21st.*

2252. Edward Abell, of Lambeth, for an improved instrument to assist the hand in writing.
2253. Henry Hales, of Brighton, for improvements in the machinery for propelling vessels.
2254. George Savage, of Adderbury, Oxfordshire, for a new or improved singeing lamp.
2255. Abraham Gerard Brade, of Paris, for improvements in the manufacture of plate and thread for gold and silver lace and bullion,—being a communication.
2256. John Maddox, of Thomas-street, Brick-lane, Edward Gardner, of Buxton-street, and George Dyer Green, of Weaver-street, for improvements in weaving fringes.
2257. George Simmons, of Liverpool-street, for improvements in the construction of railway bearers and sleepers.
2258. John Penn, of Greenwich, for improvements in the manufacture of the pistons, slide-valves, and stuffing-boxes of steam-engines.

2259. James Scott, of Argyle-square, Edinburgh, for improvements in apparatus for facilitating surgical operations and teaching anatomy.
2260. Edme Hyppolyte Marié, of Paris, for certain improvements in the machinery for preparing, spinning, and twisting cotton, silk, flax, wool, and other fibrous substances.

*The above bear date October 23rd.*

2261. Charles Cowper, of Southampton-buildings, for improvements in preparing to be spun and in spinning silk-waste,—being a communication.
2262. François Jean Bouwens, of Mechlin, for an improved rotary engine.
2263. Gustavus Adolphus Somerby and Charles William Fogg, both of Massachusetts, U. S., for an improved brake apparatus for railway carriages.
2265. Ferdinand Charles Warlich, of Suffolk-street, for improvements in generating steam.
2266. Joseph Hopkinson, the younger, of Huddersfield, for improvements in steam-engine boilers and safety-valves, and in apparatus for indicating the vacuum in steam-engine condensers, in relation to the existing atmospheric pressure.
2267. John Welsh, of Greenock, for improvements in extracting liquids from saccharine and other matters.

*The above bear date October 24th.*

2268. John Rickhuss, of Worcester, and Charles Toft, of Saint John, Bedfordshire, for improvements in the manufacture of Porcelain, china, and earthenware.
2269. Joseph Spencer, of Bilston, Staffordshire, for a new or improved fence for railway stations, docks, and such other places as the same is or may be applicable to.
2270. William Henderson, of Cannon-street, London, for improvements in treating certain ores and alloys, and in obtaining products therefrom.
2271. Alexander Southwood Stocker, of the Poultry, for certain improvements in the manufacture of tubes, applicable to gas and other purposes; also in the construction of certain engineering machinery and apparatus, and the application of the whole or part of the same to, and other means to be used or employed in, the manufacture of tubes; also in the mode of manufacturing and the application of certain articles connected with or necessary to the completion of such or other tubes.
2272. Richard Roberts, of Manchester, for improvements in machinery for preparing and spinning cotton and other fibrous substances.
2273. William Thomas Smith, of New Hampstead-road, Kentish Town, and George Hill, of the City-road, for improvements in machinery or apparatus for winnowing, washing, sifting, or separating corn, gravel, minerals, and other materials.

2274. Richard Hugh Hughes, of Hatton-garden, for improvements in transmitting motive power.
2275. Colin Mather, of Salford Iron Works, Manchester, for improvements in machinery for boring in the earth, and for actuating a hammer for driving tubes into the earth and other uses.
2276. François Lambert, of Rue d'Enfer, Paris, for improvements in compounds to be used as cosmetics.
2277. Edouard Pechenard, of Monthermé Canton, France, for certain improvements in roofs or coverings for buildings.
2278. Louis Vital Helin, of Rue des Douze Apôtres, Brussels, for improvements in the manufacture of paper from straw.
2279. John Henry Johnson, of Lincoln's-inn-fields, for improvements in circular looms,—being a communication.

*The above bear date October 25th.*

2280. William Grindley Craig, of Gorton, near Manchester, for improvements in the mode or method of consuming smoke, and in the machinery or apparatus employed therein.
2281. Richard Archibald Brooman, of Fleet-street, for an improved method of obtaining alcohol from organic substances, and particularly from wood,—being a communication.
2282. John Healy, John Foster, and John Lowe, all of Bolton-le-Moors, for improvements in machinery to be used for drawing, moulding, forming, and forging articles in metal.
2283. Joseph Eccles, of Blackburn, for improvements in machinery for the manufacture of bricks.
2284. Charles Henry Olivier, of Finsbury-square, for an improved apparatus for drying,—being a communication.
2285. Peter Armand Le Comte de Fontainemoreau, of South-street, for improvements in bleaching, dyeing, and preparing hemp and flax to be spun,—being a communication.
2286. Peter Armand le Comte de Fontainemoreau, of South-street, for improvements in transferring colored pictures, portraits, and engravings,—being a communication.
2287. James Griffiths, of Wolverhampton, for improvements in the mode or process of manufacturing certain kinds of iron, and in the machinery or apparatus used in such manufacture; part of which improvements are also applicable to machinery used in the manufacture of other descriptions of iron.
2288. John Dudgeon, of Fenchurch-street, for an improvement in rendering ships and batteries shot proof.

*The above bear date October 26th.*

2289. Auguste Edouard Loradoux Bellford, of Castle-street, for an improved mode of operating trip hammers,—being a communication.
2290. John Turner, Benjamin Holdsworth, and Robert Hartley, all of Burnley, for certain improvements in power-looms for weaving.

2291. Astley Paston Price, of Margate, for improvements in the calcination and oxidation of certain metallic mineral and metallurgical compounds, and in the apparatus and means for effecting the same.

2292. William Ashton, of Preston, Lancashire, for improvements in safety or escape-valves.

2293. William Boutland Wilkinson, of Newcastle-on-Tyne, for improvements in the construction of fire-proof dwellings, warehouses, and other buildings, or parts of the same.

*The above bear date October 27th.*

2294. Henry Adcock, of London, for improvements in strengthening castings of iron and other metals.

2295. Jabez Morgan, of Kidderminster, for improvements in machinery or apparatus for cutting metals.

2296. George Mumby, of Hunter-street, Brunswick-square, for improvements in reservoir pen-holders and other writing apparatus.

2297. Edward Lindner, of New York, for improvements in revolving breech fire-arms and magazine.

2298. Jean Pierre Savouré, of Catherine-street, Strand, for an improved gold coin detector; applicable also for weighing postal communications.

2299. Charles Blake, of St. Leonards, for a method of preventing or lessening the injurious effects arising from collisions at sea and on other navigable waters.

2300. Claude François Vauthier, of Dijon, France, for certain improvements in blowing-machines.

2301. Richard Archibald Brooman, of Fleet-street, for improvements in centrifugal machines, and in driving the same,—being a communication.

*The above bear date October 28th.*

2302. Oliver Maggs, of Bourton, Dorsetshire, for improvements in portable steam-engines.

2303. Gustave Hermann Lilie, of Amelia-villas, De Beauvoir-grove, Kingsland, for a new material for the manufacture of paper.

2304. John Wainwright, of Birkenhead, for improvements in fitting up shops, offices, and other like places, and shop fronts.

2305. John Coope Haddan, of Chelsea, for improvements in projectiles, and in machinery for manufacturing the same.

2306. Pierre Benoit Chapuis, of Place des Repentirs Guillotière, Lyons, for an improvement in the harness used for weaving,—being partly a communication.

2308. Robert Stirling Newall, of Gateshead, for improvements in electric telegraphs,—being a communication.

2309. John Henry Johnson, of Lincoln's-Inn-fields, for improvements in axle boxes,—being a communication.

*The above bear date October 30th.*



2310. Thomas Frederick Tyerman, of Weymouth-street, Portland-place, for improvements in preparing hoop-iron and such like metal surfaces, used for bondings in buildings and structures.
2311. William Reid, of University-street, for improvements in the manufacture of galvanic batteries.
2313. Charles Vorster, of Cologne, for improvements in the manufacture of ribbons.
2314. Thomas Prosser, of New York, for improvements in condensers of steam-engines and parts connected therewith.
2315. John Henry Johnson, of Lincoln's-Inn-fields, for improvements in lithographic printing presses,—being a communication.
2316. Archibald Craig, of Paisley, for improvements in the manufacture of railway-wheels.
2317. Bewicke Blackburn, of Clapham-common, for improvements in the manufacture of pipes.
2318. Thomas Osborne, and William Eldred, both of Leicester, for improvements in apparatus for retarding and stopping railway carriages.

*The above bear date October 31st.*

2320. James and William Bradshaw, of Blackburn, for improvements in time-pieces.
2321. James Rae, of Alpha-road, New Cross, for improvements in machinery or apparatus for assisting in propelling vessels.
2322. James Birsch Robb, of Boston, U.S., for improvements in brakes or retarding apparatus.
2323. Alfred Vincent Newton, of the Office for Patents, 66, Chancery-lane, for an improved method of forging or swaging railroad carriage and other wheels,—being a communication.
2324. Henry Brinton, jun., and Richard Smith, both of Kidderminster, for improvements in the manufacture of carpets, hearth-rugs, and other like fabrics.
2325. Joseph Francis, of New York, for the manufacture of wagons, caissons, and other vehicles, applicable to transport military and other stores on land and water.

*The above bear date November 1st.*

2326. John Gedge, of Wellington-street, Strand, for improvements in machinery or apparatus for grinding,—being a communication.
2327. Charles Hargrove, of Birmingham, for improvements in annealing cast-iron, or in rendering cast-iron malleable.
2328. Loring D. Dewey, of New York, for protection against fire in vessels or buildings, by putting out the fire without personal aid, or with very little, and against incendiary or fraudulent fires, and ravages of vermin,—being partly a communication.

*The above bear date November 2nd.*

2329. Henry Walmsley, and John Day, both of Failsworth, near Manchester, for improvements in looms.

2331. Claude Laurent Victor Maurice, of St. Etienne, France, for certain improvements in carbonizing coal, and in apparatus to be employed therein.
2333. Isidore Alexandre Moineau, and Jean Gustave Lemasson, both of Paris, for improvements in elastic mattresses, and seats.
2332. Nathaniel Topp, John Holt, and John Partington, all of Farnworth, for improvements in hand-mules for spinning.
2334. Edouard Alexandre, of Paris, for improvements in organ pianos.
2335. James Atherton, and John Kinlock, both of Preston, for improvements in machinery or apparatus for preparing and sizing or dressing yarns or threads.
2336. William Charles Theodore Schaeffer, of Stanhope-terrace, Hyde-park-gardens, for improvements in treating the waste washwaters of woollen and other mills.

*The above bear date November 3rd.*

2337. George Lee Baxter, of Sneinton Hermitage, Nottingham, for improvements in reaping machines.
2338. John Adcock, of Marlborough-road, Dalston, for the novel application of the stem or stalk of the tobacco leaf for various useful purposes.

*The above bear date November 4th.*

2340. Hyppolyte Bordier, of Orleans, France, for making alcohol or spirit from different plants and vegetable productions of a farinaceous nature.
2341. William Collis, of Barnes, Surrey, for an improvement in brewing.
2342. John Shaw, of Dukinfield, for improvements in guns and fire-arms.
2343. Joseph Betteley, of Liverpool, for improvements in the construction and manufacture of iron knees, and the application thereof for ships' fastenings.
2344. Frederic Rainford Ensor, of Nottingham, for improvements in bobbin net or twist lace machinery.
2346. William Childs, the younger, of Brighton, for an improvement in the manufacture of pipes and tubes.
2345. James Wallace, jun., of Glasgow, for improvements in zincographic and lithographic printing.
2347. Louis Alexandre Farjon, of Paris, for an improved system of jointing pipes, tubes, and conduits in general.
2348. Frank James Wilson Packman, of Puckeridge, Herts, for a method of compressing air in air-guns, and an improved air-gun.

*The above bear date November 6th.*

2352. Edward Hogg, of Gateshead, for improvements in shot and shell.
2354. William Henry Woodhouse, of Parliament-street, Westminster, for an improved meter for water and other liquids.

2356. Edward Simons, of Birmingham, for a new or improved candlestick.  
 2358. John Bird, of Chance's Fire-brick Works, near Dudley, for improvements in reverberatory furnaces.  
 2360. John Blaikie, of Glasgow, for improvements in the manufacture of driving-belts, straps, and bands for machinery.

*The above bear date November 7th.*

2362. Leone Glukman, of Sackville-street, Dublin, for improvements in effecting electric communications in railway trains.  
 2364. James Whitehead, of Patricroft, for certain improvements in self-acting mules.  
 2366. Charles William Siemens, of John-street, Adelphi, for improvements in electric telegraphs,—being a communication.  
 2368. William Edward Newton, of the Office for Patents, 66, Chancery-lane, for an improved mode of constructing saws,—being a communication.  
 2372. Charles Dalrymple Cranstoun, of Elgin, N.B., for improvements in coupling and uncoupling railway carriages and rolling stock.

*The above bear date November 8th.*

---

### **New Patents.**

*Sealed under Patent Law Amendment Act, 1853.*

---

1854.

- |                                     |                                  |
|-------------------------------------|----------------------------------|
| 899. Moses Poole.                   | 1032. C. B. Normand.             |
| 950. John Goucher.                  | 1036. Charles Liddell.           |
| 953. T. G. Owen.                    | 1039. W. C. Fuller.              |
| 958. Henry Clarke.                  | 1041. J. W. Hoby and J. Milner.  |
| 965. James Heywood.                 | 1042. R. Reece.                  |
| 966. A. M. Dix.                     | 1045. John Lawson.               |
| 967. Benjamin Dixon.                | 1046. Joseph Shepherd.           |
| 973. W. A. Archbald.                | 1050. John Cundy.                |
| 979. Thomas Jackson.                | 1057. William Waite.             |
| 980. William Hutton.                | 1058. C. N. Nixon.               |
| 981. J. Mayer and J. D. Kind.       | 1059. D. Campbell and J. Barlow. |
| 983. Richard Waller.                | 1073. J. A. Drien.               |
| 990. B. Bishop and J. Dyer.         | 1075. R. C. Burleigh.            |
| 995. E. H. Rascol.                  | 1078. H. Y. D. Scott.            |
| 1000. Charles Barlow.               | 1080. L. F. Saugrin.             |
| 1007. A. G. A. Martin and C. Lefol. | 1081. R. A. Brooman.             |
| 1010. A. Warner.                    | 1089. A. H. D. Durant.           |
| 1018. H. G. Drewe.                  | 1092. J. P. Baker.               |
| 1019. R. Waller.                    | 1096. Henry Carnforth.           |
| 1023. J. H. Higginbottom.           | 1098. A. V. Newton.              |
| 1024. Julian Bernard.               | 1099. C. Catlow and T. Comstive. |
| 1027. H. M. Naylor.                 | 1106. T. C. Hine.                |
| 1030. George Thomas.                | 1110. J. H. Johnson.             |

1114. J. Hinchliffe, jun.  
 1115. Charles Barlow.  
 1116. J. Cunningham & W. Ashley.  
 1118. J. A. Haberhauffe.  
 1120. P. A. Le Comte de Fontaine-  
   moreau.  
 1130. J. and W. Crossley.  
 1133. B. W. Fase.  
 1134. William England.  
 1140. R. and W. Oram.  
 1141. C. Bostock and S. Greenwood.  
 1143. T. W. and G. J. Atlee.  
 1146. William White.  
 1147. L. E. Dufour.  
 1148. E. Radigon and R. G. de Gri-  
   mouville.  
 1149. Joseph Kuczynski.  
 1172. J. A. Corwin.  
 1184. Thomas Bazley.  
 1185. Henry Kraut.  
 1193. Richard Tomlinson.  
 1194. A. E. L. Bellford.  
 1205. G. A. de Penning.  
 1206. W. E. Wiley & E. Lavender.  
 1213. Jno. Whitaker & Jas. Pickles.  
 1215. C. King and E. S. Benfield.  
 1223. Charles Maschwitz.  
 1224. Earl of Aldborough.  
 1240. A. Chavanes.  
 1242. J. B. Lindsay.  
 1243. R. A. Brooman.  
 1246. Hyppolyte Bordier.  
 1262. John Wilson.  
 1269. B. Blackburn.  
 1288. John Young.  
 1319. P. A. Le Comte de Fontaine-  
   moreau.  
 1324. George Holloway.  
 1337. Joseph Oliver.  
 1349. Robert Reeves.  
 1353. W. E. Newton.  
 1358. Henry Dembinski.  
 1365. J. F. Heather.  
 1383. A. E. L. Bellford.  
 1401. R. Bottomley, H. Spencer, and  
   D. Schofield.  
 1404. Alexander Bain.  
 1418. William Coltman.  
 1436. N. Thompson, jun.  
 1447. John Wilder.  
 1473. Joseph Burch.  
 1484. John Lamb.  
 1558. Thomas Wright.  
 1561. William Hunt.  
 1566. T. M. Woodyatt.  
 1584. J. C. Browne.  
 1585. J. Whiteley, J. Slater, and  
   W. H. Crossley.  
 1590. Jno. Sudbury and S. Wright.  
 1604. J. Knight and J. Stubbs.  
 1611. Charles Harratt.  
 1625. A. E. L. Bellford.  
 1628. H. Champonnois and J. B.  
   Bavelier.  
 1661. Alexander Law.  
 1683. J. C. D. Demay.  
 1685. Henry Green.  
 1687. A. V. Newton.  
 1703. Paul Garavaglia de Soresina.  
 1705. W. Rye and W. Crowther.  
 1760. J. Gibson.  
 1769. J. Moore, S. Beswick, and B.  
   Wilson.  
 1807. J. P. Clarke.  
 1809. W. E. Newton.  
 1811. John Coney  
 1817. Edward Lund.  
 1819. William Johnson.  
 1820. William Johnson.  
 1826. James Hodgson.  
 1827. J. Allen and J. Taylor.  
 1832. R. Brisco and P. S. Horsman.  
 1845. W. H. Merriwether.  
 1847. W. E. Newton.  
 1855. P. Fairbairn and T. Green-  
   wood.  
 1862. P. A. Le Comte de Fontaine-  
   moreau.  
 1865. J. H. Tuck.  
 1870. George Wall.  
 1873. W. Smith and T. Phillips.  
 1877. P. Fairbairn & R. Dempster.  
 1884. John Gray.  
 1887. Joseph Burridge.  
 1896. William Campion.  
 1923. R. D. Kay.  
 1929. J. L. White, H. Henderson,  
   and James Couper, sen.  
 1937. William Brownfoot.  
 1945. James Eden.  
 1969. H. R. Ramsbotham and Wil-  
   liam Brown.  
 1971. J. W. Hackworth.

\*\* For the full titles of these Patents, the reader is referred to the  
 corresponding numbers in the List of Grants of Provisional Protections.

CELESTIAL PHENOMENA FOR DECEMBER, 1854.

D. H. M.		D. H. M.	
1	Clock after the ☉ 10m. 47a.	14	Ceres, R. A., 21h. 38m. dec. 23. 38. S.
—	☽ rises 2h. 35m. A.	—	Jupiter, R. A., 20h. 5m. dec. 20. 52. S.
—	☽ passes mer. 9h. 45m. A.	—	Saturn, R. A., 4h. 41m. dec. 20. 25. N.
—	☽ sets 3h. 57m. M.	—	Uranus, R. A., 2h. 43m. dec. 15. 29. N.
18 53	♃ in conj. with the ☽ diff. of dec. 0. 26. N.	—	Mercury passes mer. 22h. 35m.
2 1 48	♄ greatest hel. lat. N.	—	Venus passes mer. 23h. 57m.
3	Occul. $\nu^1$ Tauri, im. 15h. 27m. em. 16h. 4m.	—	Mars passes mer. 1h. 49m.
4	Occul. 103 Tauri, im. 8h. 15m. em. 8h. 53m.	—	Jupiter passes mer. 2h. 33m.
1 34	Ecliptic oppo. or ☉ full moon.	—	Saturn passes mer. 11h. 8m.
3	♃ in conj. with the ☽ diff. of dec. 3. 41. S.	—	Uranus passes mer. 9h. 11m.
7 13	♃ oppo to the ☉	15	Clock after the ☉ 4m. 40a.
5	Clock after the ☉ 9m. 12a.	—	☽ rises 2h. 13m. M.
—	☽ rises 4h. 14m. A.	—	☽ passes mer. 7h. 54m. M.
—	☽ passes mer. 4h. 11m. M.	—	☽ sets 1h. 22m. A.
—	☽ sets 8h. 56m. M.	18 3 31	♄ in conj. with the ☽ diff. of dec. 2. 31. N.
—	Occul. 139 Tauri, im. 6h. 24m. em. 7h. 7m.	19 9 47	Ecliptic conj. or ● new moon.
6 12 49	♄ greatest elong. 20. 41. W.	12 30	♀ in conj. with the ☽ diff. of dec. 2. 46. N.
8 11	☽ in Apogee.	20	Clock after the ☉ 2m. 12s.
9 6 56	♀ in the descending node.	—	☽ rises 9h. 10m. M.
10	Clock after the ☉ 7m. 1s.	—	☽ passes mer. 0h. 36m. A.
—	☽ rises 9h. 23m. A.	—	☽ sets 4h. 2m. A.
—	☽ passes mer. 4h. 20m. M.	20 15	☽ in Perigee.
—	☽ sets 0h. 14m. A.	21 12 37	♃ in conj. with the ☽ diff. of dec. 4. 23. N.
—	Occul. B.A.C. 4277, im. 15h. 57m. em. 16h. 24m.	15	☉ enters Capricornus,—Winter commences.
—	Occul. $i$ Leonis, im. 17h. 44m. em. 19h. 2m.	22 10 28	Vesta in conj. with ♃ diff. of dec. 2. 34. N.
—	Pallas in conj. with ♃ diff. of dec. 20. 21. N.	25	Clock before the ☉ 0m. 19s.
12 6 11	☽ in ☐ or last quarter.	—	☽ rises 0h. 0m. A.
22 30	♀ in sup. conj. with the ☉	—	☽ passes mer. 5h. 28m. A.
13	Occul. B. A. C. 4277, im. 15h. 46m. em. 15h. 59m.	—	☽ sets 11h. 10m.
14	Mercury, R. A., 16h. 4m. dec. 19. 19. S.	13 22	♄ in the descending node.
—	Venus, R. A., 17h. 27m. dec. 23. 26. S.	26 0 38	☽ in ☐ or first quarter
—	Mars, R. A., 19h. 20m. dec. 23. 19. S.	27	Occul. $\mu$ Piscium, im. 6h. 36m. em. 7h. 39m.
—	Vesta, R. A., 16h. 35m. dec. 18. 53. S.	28 23 10	♃ in conj. with the ☽ diff. of dec. 0. 25. N.
—	Juno, R. A., 15h. 3m. dec. 9. 24. S.	31	Occul. 103 Tauri, im. 16h. 58m. em. 17h. 20m.
—	Pallas, R. A., 20h. 6m. dec. 0. 51. S.	5 21	♃ in conj. with the ☽ diff. of dec. 3. 29. S.

J. LEWTHWAITE, Rotherhithe.

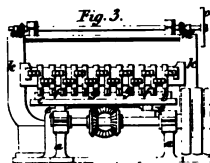

*Kraut's blasting rock*

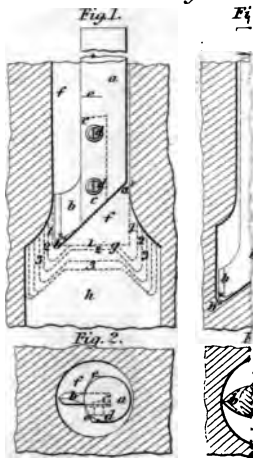

*Chappuis' diurnal ri*

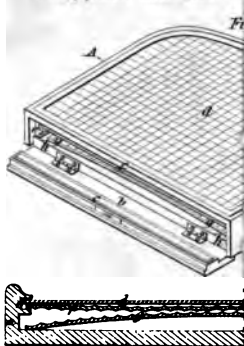

*Newton's imp<sup>ta</sup> in d*

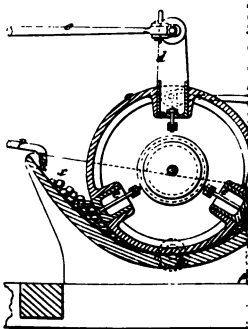

1

18 8

2 14

3

4

10

8

7 1

5

6 12 4

8 11

9 6 4

10

12 6 1

13 22 3

14

15

Fig. 3.

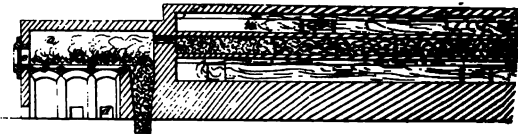

Fig. 1.



Fig. 5.

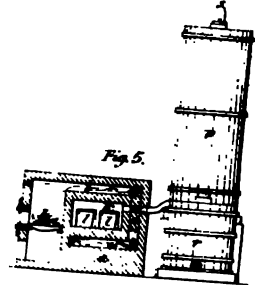
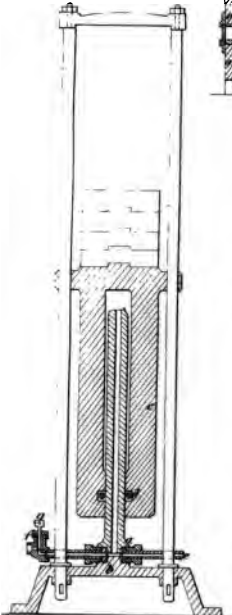

Fig. 1.



May's imp<sup>2</sup> bris

Fig. 2.

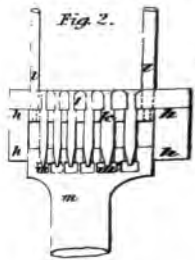
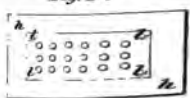

Fig. 3.



gran's gold crushing mach<sup>2</sup>.

Fig. 1.

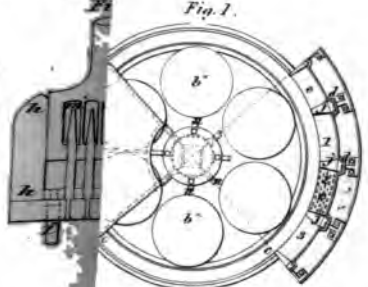

Fig. 2.

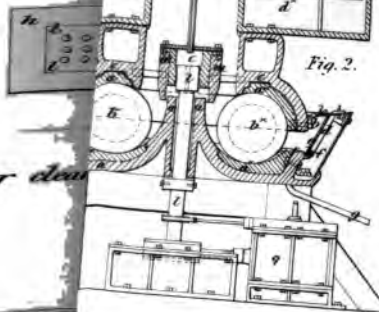
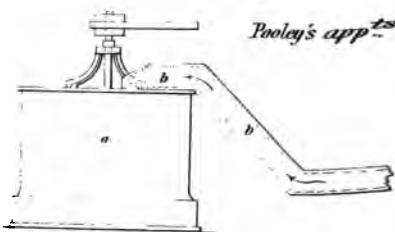
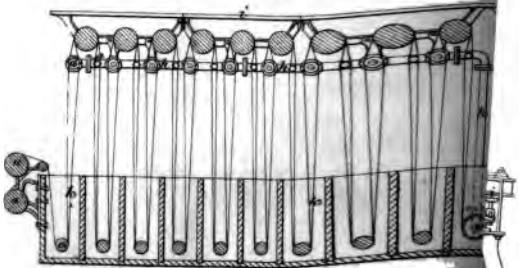

Fig. 2.

Pooley's app<sup>ts</sup> for dea



Worrall's imp<sup>ts</sup> in dying



Reeves' Sworls.

Fig. 1.

Fig. 2.





D. H. M

1  
—  
—  
—  
18 5  
2 1 4  
3

4

1 8

3

7 1

5

6 12 4  
8 11  
9 6 5  
10

12 6 1  
22 3

13

14



6.

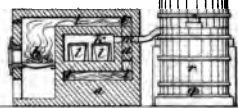
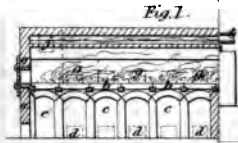
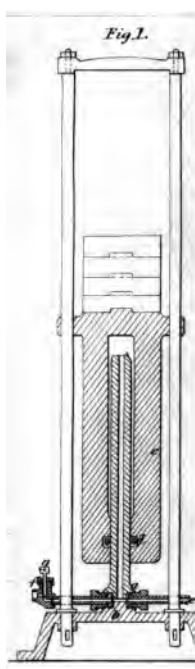

ran's gold crushing mach<sup>y</sup>.

May's imp<sup>d</sup>.

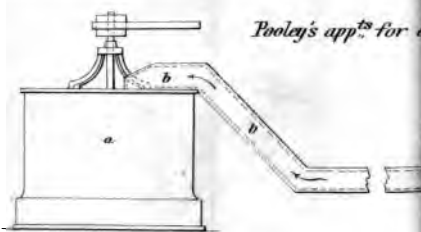
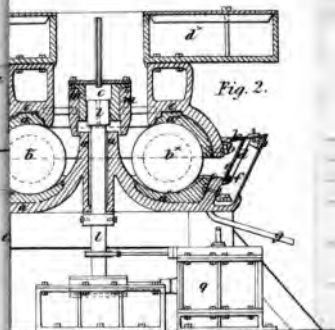
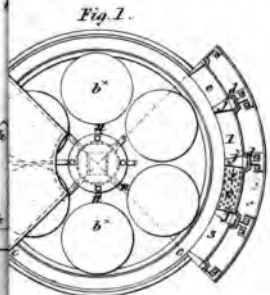
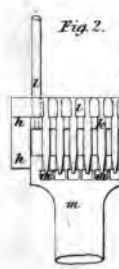

Reeves' Sworls.

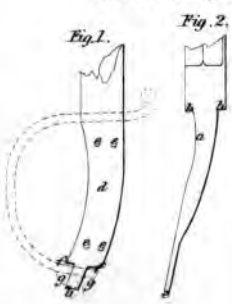
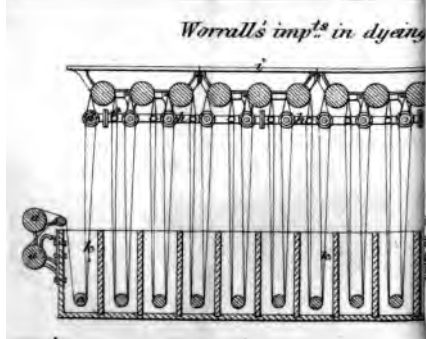

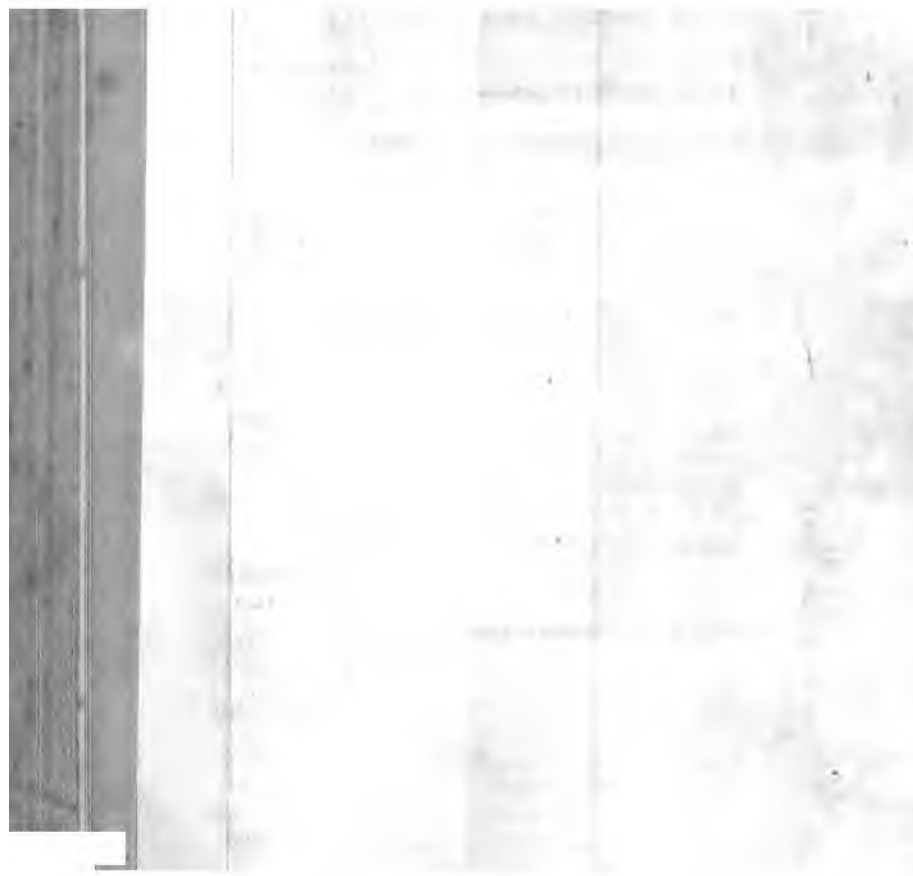

Johnson's imp<sup>d</sup> steam engines.

Fig. 1.

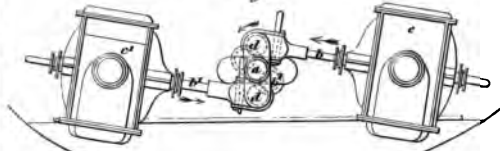
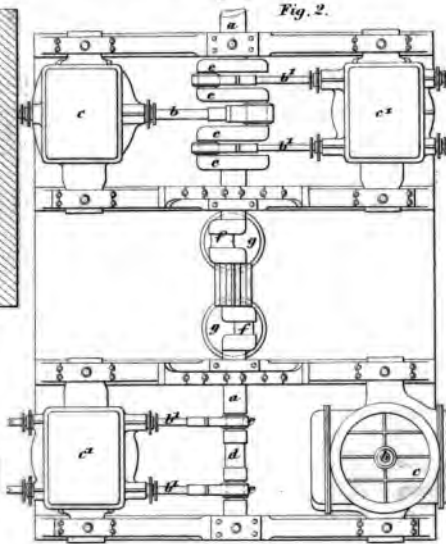

Fig. 2.



Huntley's imp<sup>ts</sup> in steam engines.

Fig. 1.

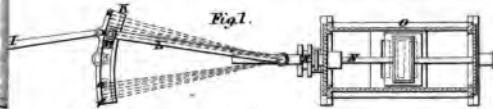

Fig. 2.

Fig. 3.

Fig. 4.

Fig. 6.



Fig. 5.

Fig. 8.

Fig. 10.

Fig. 11.

Fig. 12.

Fig. 9.

Fig. 7.

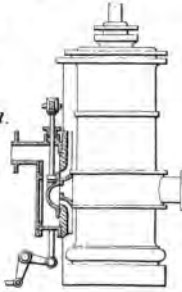
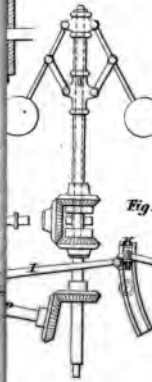



*[The text in this section is extremely faint and illegible. It appears to be a list or a table with multiple columns and rows, possibly containing names and dates.]*

Breffitt's glass-house pots.

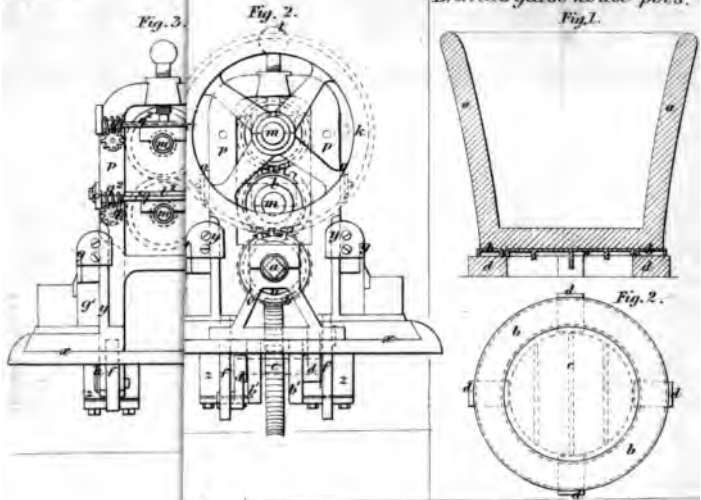

Bessemer's sugar moulding app'ts.

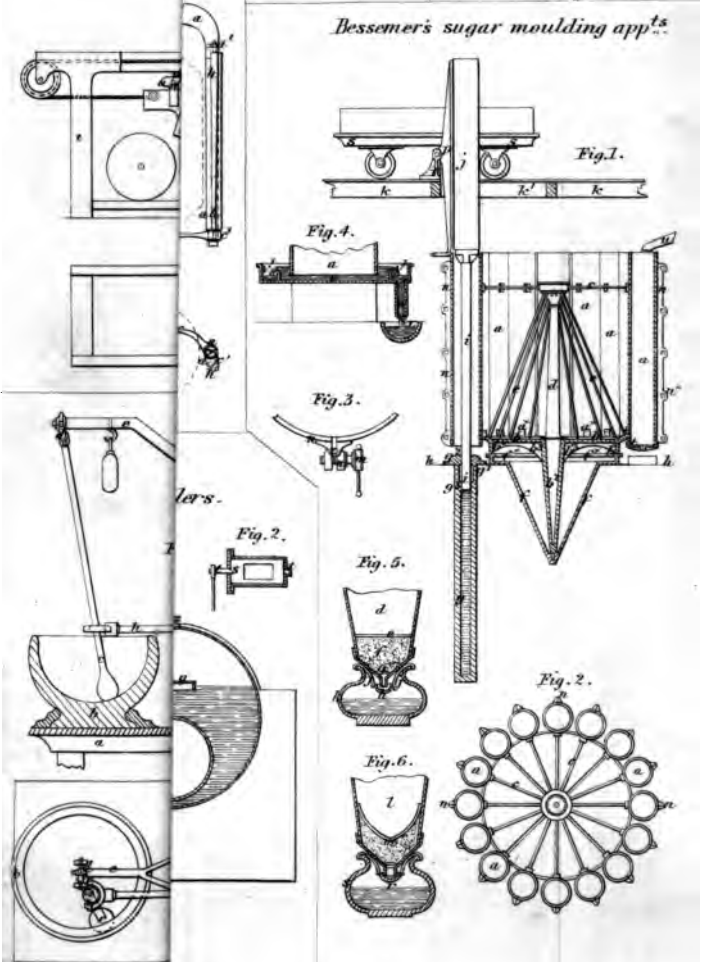

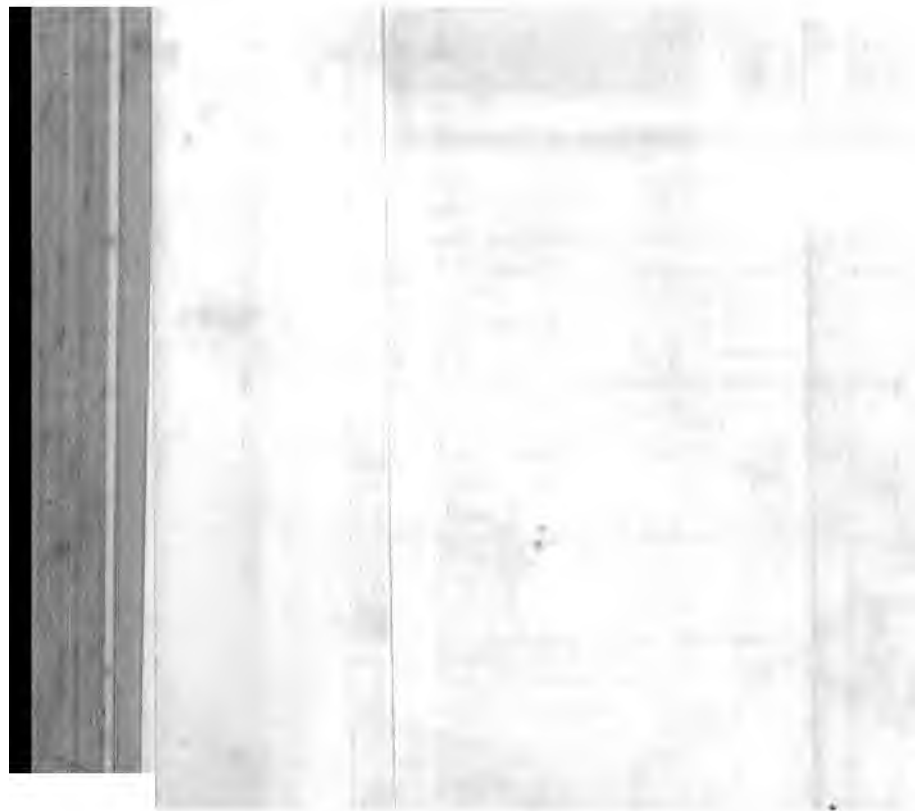

*Adam's' sh's imp<sup>ts</sup> in filters.*

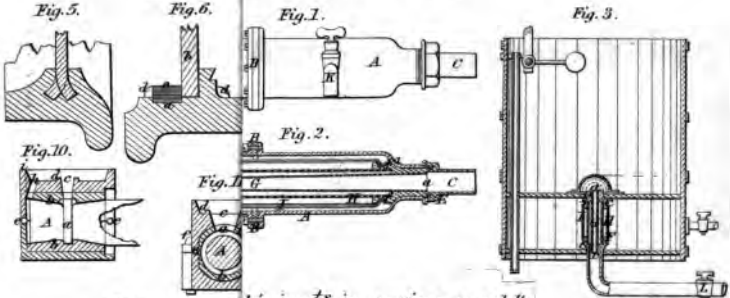

*Adam's imp<sup>ts</sup> in sewing mach<sup>y</sup>.*

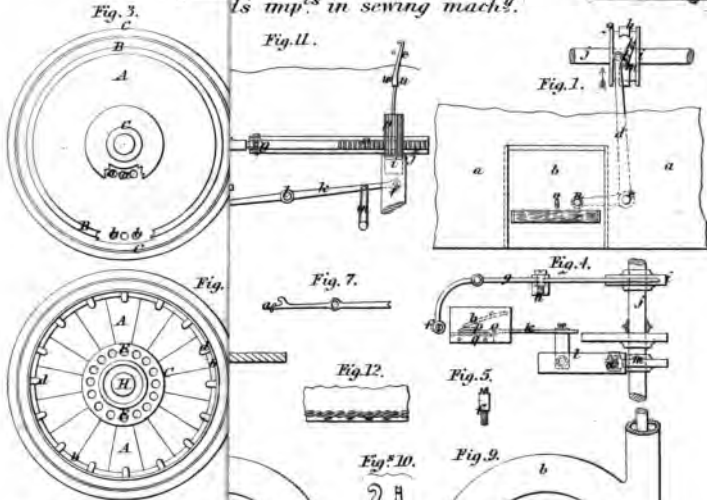

*Hughes' embossing*

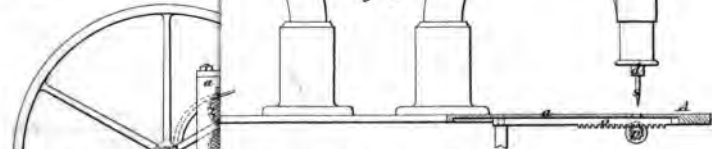

*Dickson's flax breaker.*

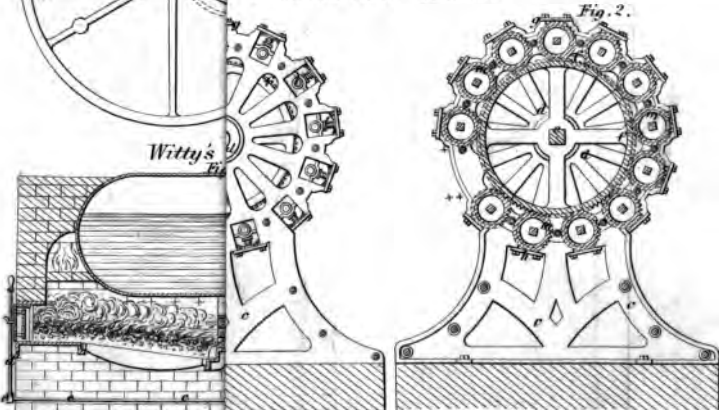

*Witty's*

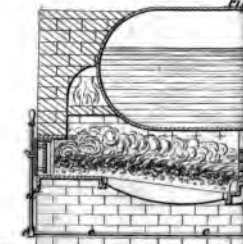



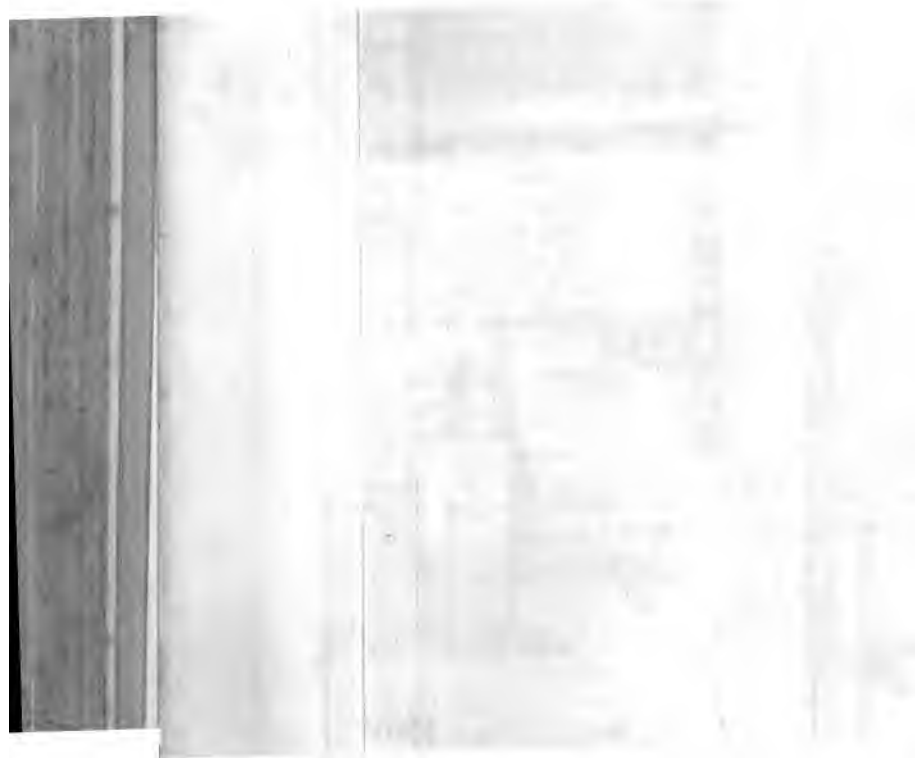

Andrew's window sash fastener

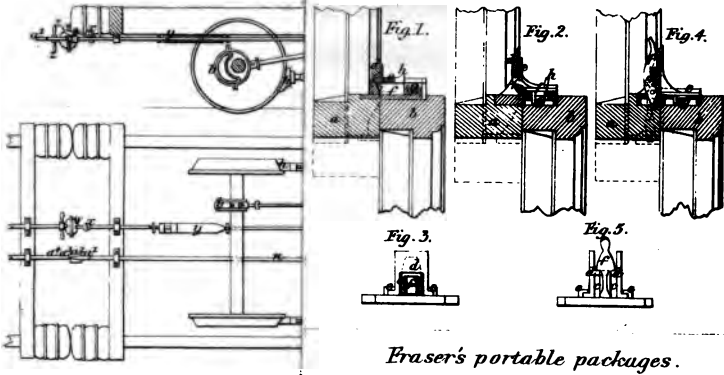

Eraser's portable packages.

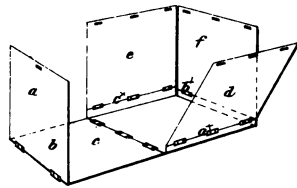

Newton's

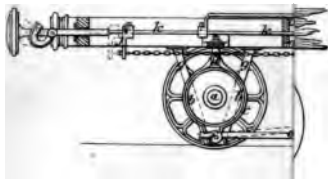

Lovell's app<sup>ts</sup> f

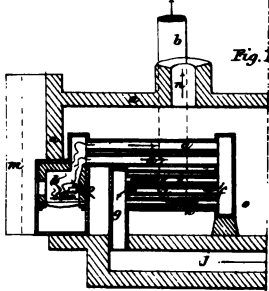

Brooman's carding silk

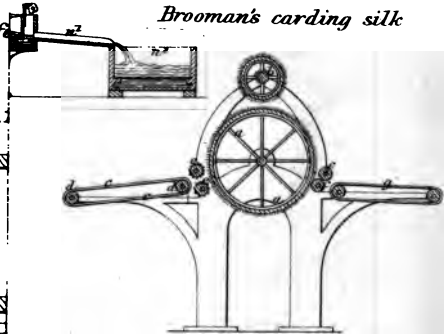

Crabtree's winding yarn.

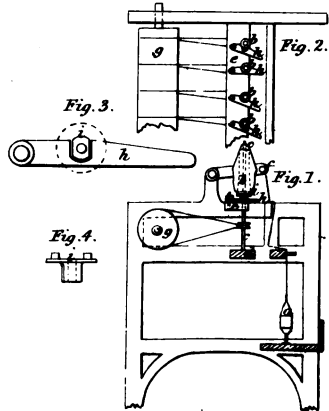
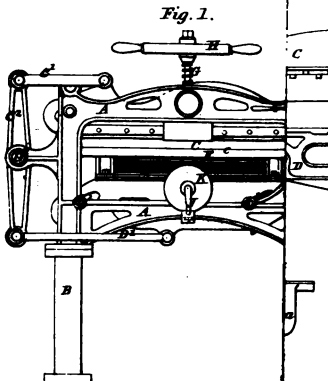



les imp<sup>tes</sup> in coupling pipes.

De Berquès n<sup>o</sup> 6.

Fig. 7.

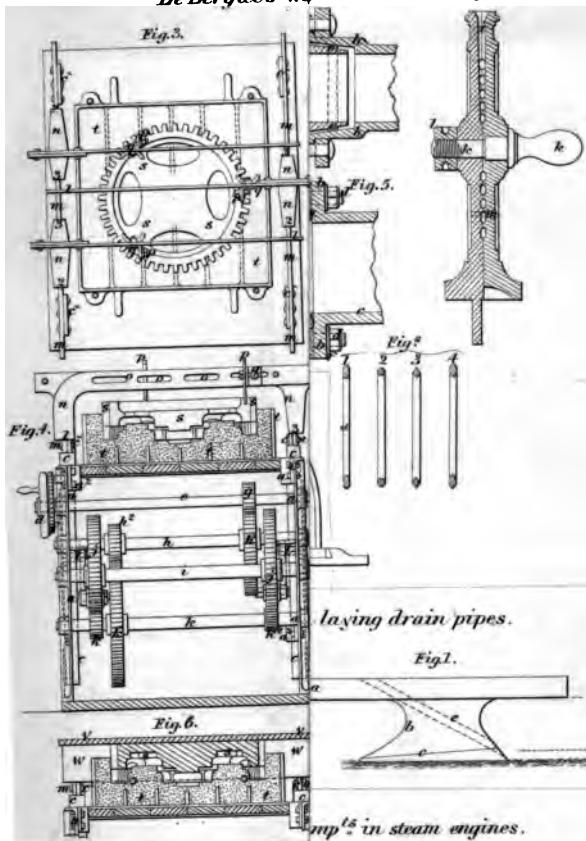

imp<sup>tes</sup> in steam engines.

Williams' wat

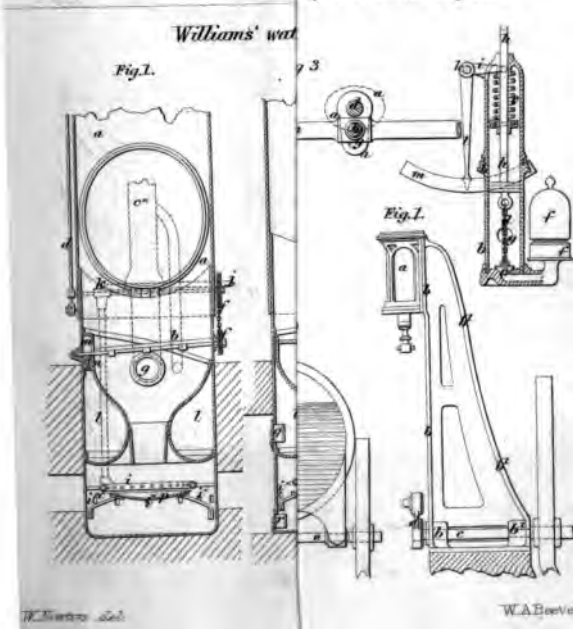

The image shows a document page that is extremely blurry and out of focus. The content is illegible, but it appears to be a table or a form with several columns and rows. The left side of the page is dark, possibly representing the binding or the edge of the scanner. The overall appearance is that of a poor-quality scan of a document.

Westley's app<sup>ts</sup> for combin<sup>g</sup>.

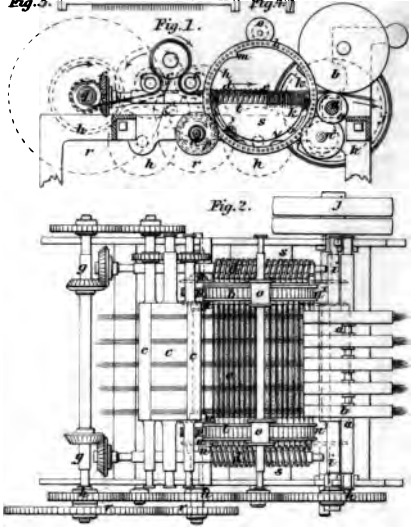
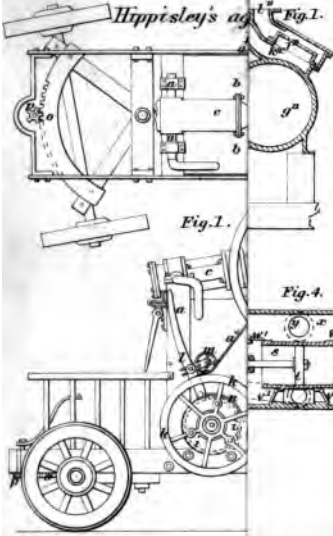

Willis' imp<sup>ts</sup> in railway waggons.

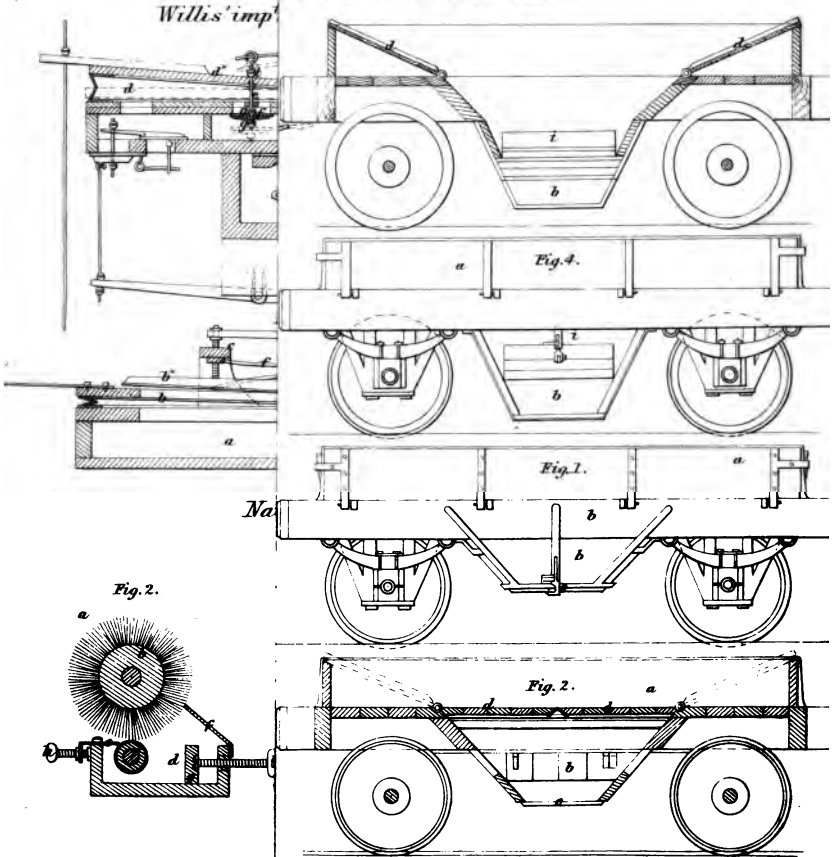



1

*Whitehead*

*Leeson's imp<sup>d</sup> gas burners.*

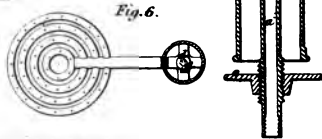
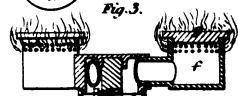
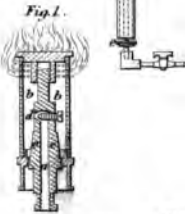
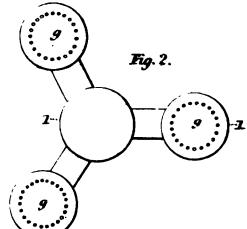
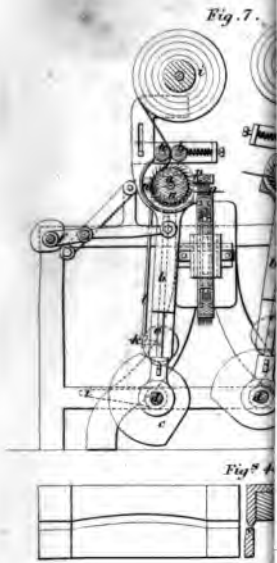

Fig. 8.



*Twig & Silvester's*

*Chisholm's manufacturing manure.*

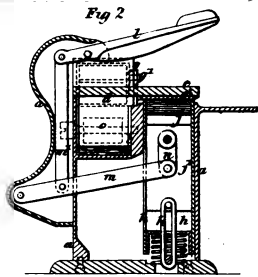
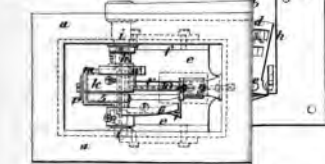
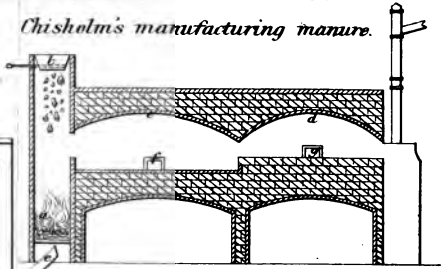
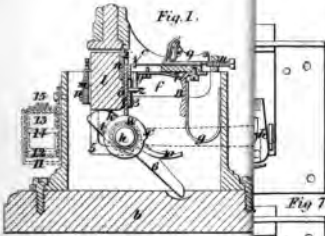
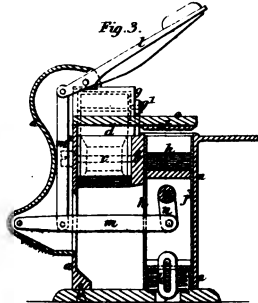
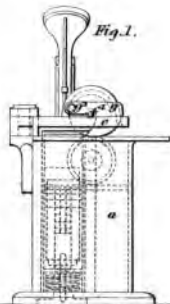
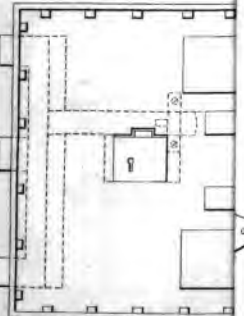

Fig. 3.

*fixing stamps.*







Howell & Jamieson's sa

Rigby's imp<sup>d</sup> steam hammers.

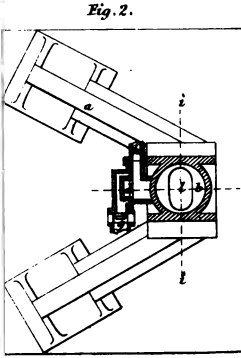
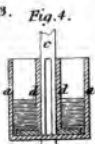
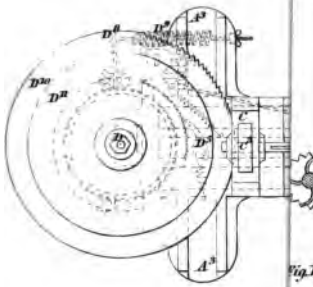
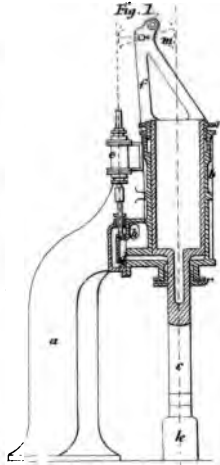
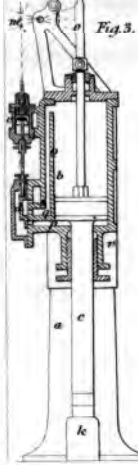
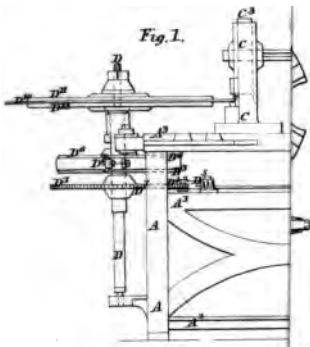

ing rollers.

Ratio & Verdel's preserving.

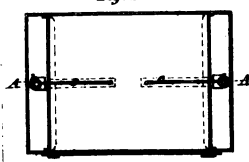
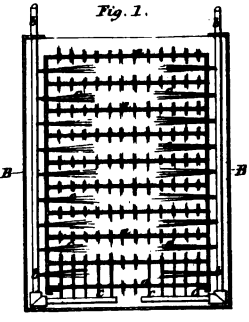
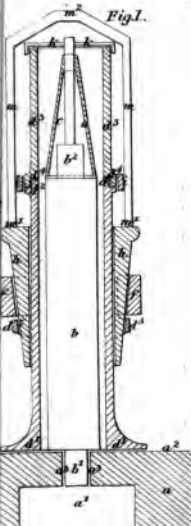
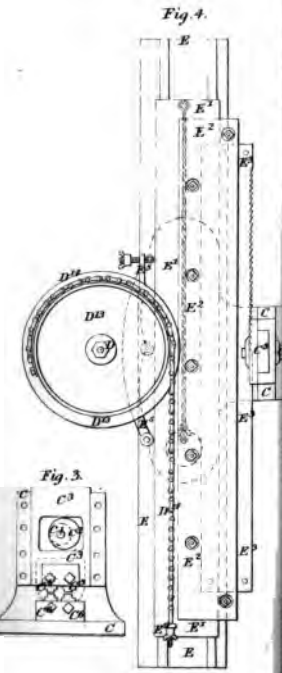



Townsend's sewing mach

Fig. 1.

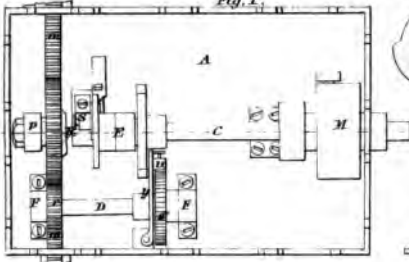

Fig. 2.

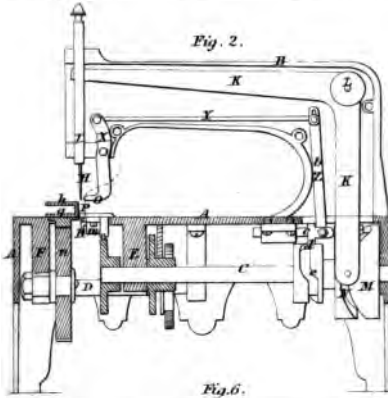

Fig. 6.



Fig. 7.

Jennings's sewing mach<sup>y</sup>

Fig. 1.

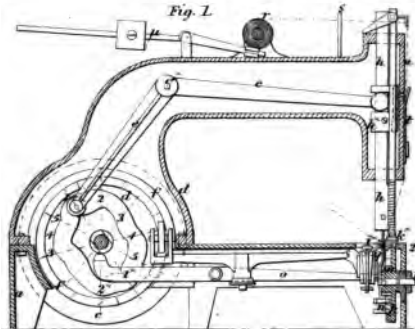

Fig. 3.

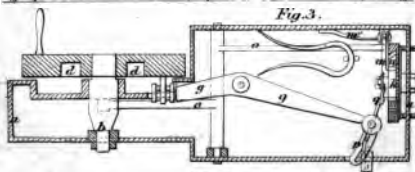

Fig. 5.



Bernard's boots & shoes.

Fig. 6.

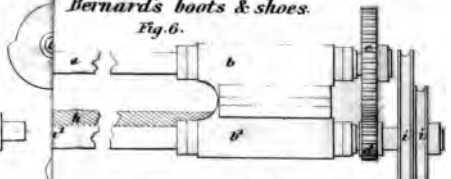
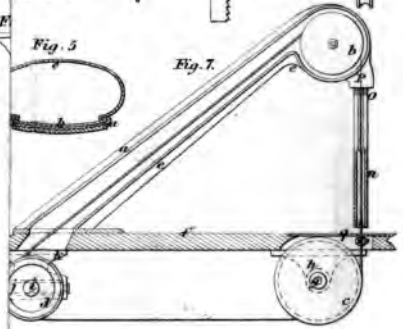

Fig. 5.

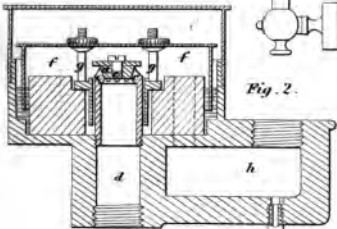
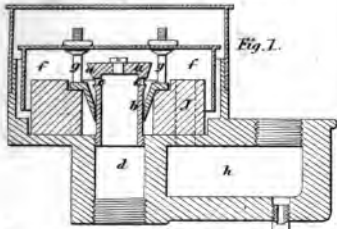

Fig. 7.





*Clibran's gas regulators.*



*Hulett's gas regulators*

Fig. 2.

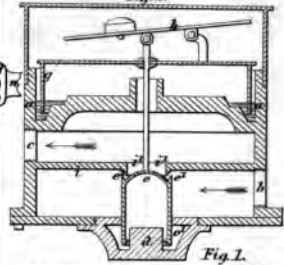

Fig. 1.

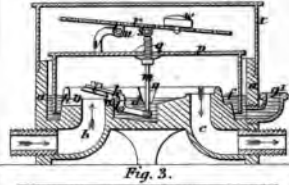
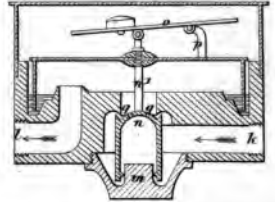
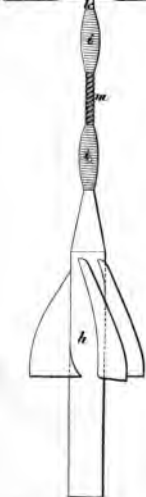
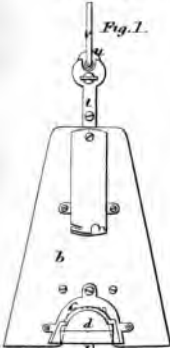

Fig. 3.



*Masseys imp'd ship's log.*



*imp's in steam engines.*

Fig. 1.

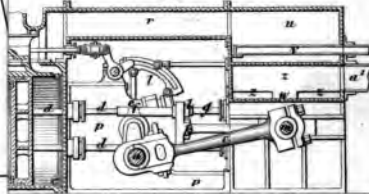
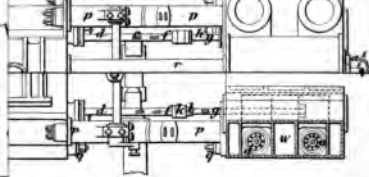

Fig. 3.



*Jobson's Castin*

Fig. 10.



Fig. 12.



Fig. 4.

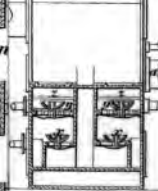

Fig. 5.

